

## TABLE OF CONTENTS

<b>TABLE OF CONTENTS</b> .....	I
<b>LIST OF TABLES</b> .....	IV
<b>LIST OF EXHIBITS</b> .....	V
<b>LIST OF APPENDICES</b> .....	VI
1.0 INTRODUCTION .....	1
1.1 Project Background .....	1
1.2 Project History .....	1
1.2.1 Federal Project Designations .....	1
1.2.2 Kentucky Project Designations .....	2
1.2.3 Ohio Project Designations .....	3
1.2.4 Metropolitan Planning Organization Project Designations .....	3
1.3 Study Area .....	4
1.4 Summary of Purpose and Need .....	5
1.4.1 Traffic Flow and Level of Service .....	6
1.4.2 Safety .....	7
1.4.3 Geometric Deficiencies .....	8
1.4.4 National, Regional, and Local System Linkage .....	8
1.5 Purpose of Report .....	9
2.0 DEVELOPMENT OF CONCEPTUAL ALTERNATIVES .....	9
2.1 Alternatives Considered and Dismissed .....	9
2.2 Conceptual Alternatives Recommended for Further Study .....	10
2.3 Step 5 Conceptual Alternatives .....	10
2.3.1 Alternative A .....	11
2.3.2 Alternative B .....	12
2.3.3 Alternative C .....	14
2.3.4 Alternative D .....	15
2.3.5 Alternative E .....	16
2.3.6 Alternative F .....	18
2.3.7 Alternative G .....	19
2.3.8 Alternative H .....	20
2.3.9 Conceptual Alternatives Summary .....	21
2.4 Alternatives Eliminated from Further Consideration .....	27
2.4.1 Elimination of Alternative A .....	27
2.4.2 Elimination of Alternative F .....	28
2.4.3 Elimination of Alternative H .....	28
2.5 Western Hill Viaduct Interchange Sub-Alternatives .....	29
2.6 Alternative Design Criteria .....	30
2.6.1 Design Criteria .....	30
2.6.2 Design Exceptions .....	37
3.0 AFFECTED ENVIRONMENT .....	38
3.1 Existing Roadway Network .....	38
3.1.1 Other Improvements to the I-75 Corridor .....	39
3.2 Existing Traffic .....	40
3.2.1 Mainline Segment Analyses .....	40
3.2.2 Ramp-Freeway Junctions .....	41
3.2.3 Local Street At-Grade Intersections .....	41
3.2.4 Origin-Destination Studies .....	41
3.3 Social Environment .....	43
3.3.1 Neighborhood and Community Cohesion .....	43

**ODOT PID 75119**  
**KYTC Item No. 6-17**  
**Conceptual Alternatives Study**

---

3.3.2	Environmental Justice .....	44
3.3.3	Community Services and Facilities.....	44
3.3.4	Land Use .....	47
3.3.5	Economy and Employment.....	47
3.4	Natural Environment.....	48
3.4.1	Geotechnical.....	48
3.4.2	Aquatic Resources .....	50
3.4.3	Wetlands.....	50
3.4.4	Terrestrial Resources .....	51
3.4.5	Threatened and Endangered Species.....	51
3.4.6	Floodplains .....	53
3.5	Cultural Resources .....	53
3.6	Section 4(f) Resources .....	56
3.7	Section 6(f) Resources .....	59
3.8	Hazardous Materials .....	59
3.9	Noise .....	60
3.10	Utilities.....	63
3.11	Transportation .....	64
3.11.1	Pedestrian and Bicycle Facilities .....	64
3.11.2	Transit.....	64
4.0	EVALUATION OF THE ALTERNATIVES .....	64
4.1	Traffic and Capacity Analyses.....	65
4.1.1	Traffic Volumes.....	65
4.1.2	Capacity Analyses .....	65
4.1.3	Development of Certified Traffic.....	66
4.1.4	Future Traffic Demand (2035) .....	67
4.1.5	Mainline Segment Analysis .....	67
4.1.6	Ramp-Freeway Junctions.....	73
4.1.7	Local Street At-Grade Intersections .....	76
4.2	Social Environment .....	79
4.2.1	Land Use .....	79
4.2.2	Neighborhood and Community Cohesion.....	81
4.2.3	Community Facilities and Resources .....	82
4.2.4	Public Safety and Emergency Services.....	84
4.2.5	Social Groups .....	85
4.2.6	Travel Patterns and Accessibility.....	85
4.2.7	Displacements and Relocations .....	86
4.2.8	Economy and Employment.....	95
4.2.9	Environmental Justice .....	97
4.3	Natural Environment.....	99
4.3.1	Aquatic Resources .....	99
4.3.2	Wetlands.....	100
4.3.3	Terrestrial Resources .....	101
4.3.4	Threatened and Endangered Species.....	101
4.4	Cultural Resources .....	102
4.5	Hazardous Materials .....	105
4.6	Visual Quality .....	107
4.6.1	Bridge Structure and River Crossing Zone.....	107
4.6.2	Ohio and Kentucky Corridor Zones .....	107
4.7	Transportation .....	108

---

4.7.1	Pedestrian and Bicycle Facilities .....	108
4.7.2	Transit.....	108
4.8	Section 4(f) and 6(f) Resources .....	109
4.9	Noise .....	112
4.9.1	No Build Alternative .....	118
4.9.2	Conceptual Build Alternatives.....	119
4.10	Utilities.....	119
5.0	PUBLIC INVOLVEMENT AND AGENCY COORDINATION .....	128
5.1	Public Involvement .....	128
5.1.1	Advisory and Aesthetic Committees.....	129
5.1.2	Project Web Site.....	129
5.1.3	Project Newsletters.....	129
5.1.4	Media Relations.....	130
5.1.5	Roving Project Display .....	130
5.2	Public Meetings and Concurrence Points .....	130
5.2.1	Community Meetings.....	130
5.2.2	Concurrence Point #1.....	131
5.2.3	Public Comments .....	131
5.2.4	Concurrence Point #2.....	133
5.3	Agency Coordination .....	134
5.3.1	Participating and Cooperating Agencies .....	134
5.3.2	Natural Resources Coordination .....	135
5.3.3	Cultural Resources Coordination.....	136
5.3.4	Section 4(f) Coordination.....	137
5.4	Utility Coordination .....	137
5.4.1	Railroad Coordination.....	138
6.0	STRATEGIC PLAN .....	139
6.1	Project Development Process .....	139
6.2	Alternatives Description.....	141
6.3	Project Phasing and Construction Sequencing .....	142
6.3.1	Construction Approach .....	142
6.4	Financial Strategy.....	148
6.4.1	National High Priority Corridor Financial Listings .....	148
6.4.2	Financial Plan.....	149
6.4.3	Estimated Costs for Conceptual Alternatives .....	153
6.5	Actions and Next Steps .....	157
6.5.1	Implementation Team.....	157
6.5.2	Public Involvement .....	158
6.6	Schedule .....	158
7.0	CONCLUSIONS AND RECOMMENDATIONS .....	159
7.1	No Build Alternative .....	159
7.2	Alternative B.....	160
7.2.1	Alternative B Evaluation .....	161
7.3	Alternative C.....	163
7.3.1	Alternative C Evaluation .....	163
7.4	Alternative D.....	165
7.4.1	Alternative D Evaluation .....	165
7.5	Alternative E .....	167
7.5.1	Alternative E Evaluation .....	168
7.6	Alternative G.....	169

7.6.1	Alternative G Evaluation .....	170
7.7	Feasible Alternatives .....	171
7.7.1	Recommended Feasible Alternatives.....	172
8.0	REFERENCES.....	185

## **LIST OF TABLES**

Table 1.	Interstates 75 and 71 as Listed Under Section 1105(c).....	1
Table 2.	High Priority Projects Listed Under SAFETEA-LU Located in or near the Brent Spence Bridge Replacement/Rehabilitation Project .....	2
Table 3.	Summary of Design Elements.....	23
Table 4.	Geometric Design Criteria.....	33
Table 5.	Comparison of I-75 Freeway Segments between 2005 and 2035 .....	41
Table 6.	Community Facilities and Services .....	44
Table 7.	Federal and State Listed Threatened and Endangered Species with Potential Habitat in the Study Area .....	51
Table 8.	Kentucky Architectural Properties Listed or Eligible for Listing in the NRHP ....	55
Table 9.	Ohio Architectural Properties Listed or Eligible for Listing in the NRHP .....	56
Table 10.	Section 4(f) Resources in Kentucky .....	57
Table 11.	Section 4(f) Resources in Ohio .....	58
Table 12.	Ambient Noise Levels in Kentucky.....	61
Table 13.	Ambient Noise Levels in Ohio .....	62
Table 14.	Summary of LOS for Freeway Segments of the Conceptual Alternatives .....	68
Table 15.	Comparison of Freeway Segments by Conceptual Alternative .....	70
Table 16.	Comparison of Ramp Junctions by Conceptual Alternative .....	73
Table 17.	Comparison of Intersections by Conceptual Alternative .....	77
Table 18.	Land Use Converted to Right of Way (Acres).....	79
Table 19.	Kentucky Recreation Facilities Impacts .....	83
Table 20.	Ohio Recreation Facilities Impacts.....	83
Table 21.	Estimated Residential Displacements.....	87
Table 22.	Estimated Business Displacements.....	88
Table 23.	Potential Displacement Locations .....	88
Table 24.	Highway-related Business Displacements within Impact Area .....	95
Table 25.	Stream Impacts .....	99
Table 26.	Wetland Impacts .....	101
Table 27.	Historic Resources Impacts .....	103
Table 28.	Lewisburg Historic District Properties within Impact Limits .....	104
Table 29.	Sites Recommended for Phase I Environmental Site Assessments .....	105
Table 30.	Section 4(f) Resource Impacts.....	110
Table 31.	Projected Noise Levels in Kentucky.....	114
Table 32.	Projected Noise Levels in Ohio .....	116
Table 33.	Utility Impacts in Kentucky .....	120
Table 34.	Utility Impacts in Ohio .....	123
Table 35.	Project Meetings and Presentations within the .....	130
Table 36.	Summary of Public Comments.....	131
Table 37.	Agencies Invited to Participate.....	134
Table 38.	Agency Coordination.....	135
Table 39.	Consulting Parties .....	136
Table 40.	ODOT's Major PDP Steps 5 through 14 .....	139

Table 41. High Priority Projects Listed Under SAFETEA-LU Located in or near the Brent Spence Bridge Replacement/Rehabilitation Project .....	148
Table 42. Financial Plan for Brent Spence Bridge Replacement/Rehabilitation Project .....	152
Table 43. Real Estate Costs (2012) (in millions).....	155
Table 44. Project Development Costs (in millions) .....	156
Table 45. Total Cost Estimates for Mainline Alternatives (Kentucky) in.....	156
Table 46. Total Cost Estimates for Mainline Alternatives (Ohio) in.....	157
Table 47. Total Cost Estimates for Mainline Alternatives (Combined) in .....	157

## **LIST OF EXHIBITS**

Exhibit 1.	Regional Map
Exhibit 2.	Study Area
Exhibit 3.	Crash Analysis by Roadway Segment (2005 – 2007)
Exhibit 4A – 4B.	Alternative A
Exhibit 5A – 5B.	Alternative B
Exhibit 6A – 6B.	Alternative C
Exhibit 7A – 7B.	Alternative D
Exhibit 8A – 8B.	Alternative E
Exhibit 9A – 9B.	Alternative F
Exhibit 10A – 10B.	Alternative G
Exhibit 11A – 11E.	Community Facilities and Resources
Exhibit 12A – 12B.	Populations Below Poverty by Census Tract
Exhibit 12C – 12D.	Minority Populations by Census Tract
Exhibit 13A – 13B.	Existing Land Use
Exhibit 14A – 14B.	Soil and Geologic Hazards
Exhibit 15A – 15D.	Ecological Features
Exhibit 16A – 16E.	Cultural Resources
Exhibit 17A – 17B.	Section 4(f) Resources
Exhibit 18A – 18C.	Recommended Phase I Environmental Site Assessment (ESA) Locations
Exhibit 19A – 19B.	Noise Measurement Locations
Exhibit 20A – 20G.	Potential Utility Impacts
Exhibit 21A – 21D.	Potential Displacements
Exhibit 22.	Alternative B I-71 Alignment Evaluation

## **LIST OF APPENDICES**

- Appendix A. Level of Service and Traffic Data - Click [Here](#)
- Appendix B. Typical Sections - Click [Here](#)
  - Cross Section Layout Plan
  - Cross Sections
  - Bridge Cross Sections
- Appendix C. Engineering Files – Click [Here](#)
  - Geometric Design Exceptions
  - Geometric Plan and Profiles
  - Signage Plan
  - Line Diagrams
- Appendix D. Cost Estimates – Click [Here](#)
- Appendix E. Public Involvement Activities and Coordination – Click [Here](#)
  - Summary of Concurrence Point #1
  - Public Comments Received
  - Project Newsletters
  - Potential Employment and Property Impact Survey (January 2009)
- Appendix F. Previous Reports
  - Purpose and Need Statement (May 2006) – Click [Here](#)
  - Red Flag Summary (December 2005) – Click [Here](#)
  - Existing and Future Conditions (February 2006) – Click [Here](#)
  - Planning Study Report (September 2006) – Click [Here](#)
  - Public Involvement Plan (October 2005) – Click [Here](#)
  - Origin – Destination Study (March 2006) – Click [Here](#)
  - I-71/US 50 Origin – Destination Study (January 2007) – Click [Here](#)
- Appendix G. Utility Coordination – Click [Here](#)
- Appendix H. Constructability Workshop – Click [Here](#)

## **Executive Summary**

The Brent Spence Bridge Replacement/Rehabilitation *Conceptual Alternatives Study* report, submitted as part of Step 5 of the Ohio Department of Transportation (ODOT) Project Development Process (PDP), identifies the feasible alternatives to be further studied in Step 6 of the PDP. As part of the process for identifying the selected feasible alternatives, this report discusses the results of engineering, traffic, and environmental studies completed for the development of the conceptual alternatives.

The Brent Spence Replacement/Rehabilitation Project was initiated from a proposal by the Kentucky Transportation Cabinet (KYTC) and Ohio Department of Transportation (ODOT) in cooperation with the Federal Highway Administration (FHWA) to improve the operational characteristics of I-71, I-75 and the Brent Spence Bridge in the Greater Cincinnati/Northern Kentucky region. This project is being undertaken to improve the operational characteristics through the corridor, for both local and through traffic, by adding capacity, improving safety, and correcting geometric deficiencies while maintaining connections to key regional and national transportation corridors.

The I-71/I-75 corridor in the Greater Cincinnati/Northern Kentucky region, suffers from congestion and safety-related issues as a result of inadequate capacity to accommodate current traffic demand and geometric design deficiencies. The I-75 corridor is a major north-south transportation corridor through the Midwestern United States and one of the region's busiest trucking routes. Traffic volumes have increased far beyond what was originally envisioned when the corridor was constructed in the 1950s and are anticipated to continue to increase. This increase in traffic volume has caused the I-75 corridor to be characterized as having poor levels of service which threaten the overall efficiency of moving people and goods throughout the region. A key link in the I-71/I-75 corridor is the Brent Spence Bridge.

### **Purpose and Need**

The Brent Spence Bridge provides an interstate connection over the Ohio River carrying traffic from both I-71 and I-75 and facilitating travel between Covington, Kentucky and downtown Cincinnati, Ohio. The bridge, which was opened to traffic in 1963, was originally designed to carry 80,000 vehicles per day. Currently nearly double that amount use the bridge daily and traffic volumes are projected to increase to nearly 200,000 vehicles per day by 2035. The increased traffic volumes make it necessary to improve capacity to avoid an increase in travel time delays and transportation costs for motorists traveling the corridor. Capacity improvements should also be accompanied by a correction of the bridge's geometric design deficiencies

The geometric design features of both I-71 and I-75 within the study area do not meet the current standards for an interstate highway facility and would be corrected as part of this project. These design deficiencies include substandard vertical alignments which allow for only limited stopping sight distances; acceleration and deceleration lanes which are not of sufficient length for anticipated traffic volumes and movements; and narrow shoulders which present safety hazards and make maintenance of traffic difficult, contributing to traffic related delays.

Safety is another issue that would be addressed by this project. Crash rates for the corridor exceed both the Kentucky and Ohio statewide averages. The high crash rates

are due in large part to the congested traffic conditions as well as deficient and substandard roadway geometry.

### **Alternatives Development**

The development of conceptual alternatives for the Brent Spence Bridge was initiated in 2003 by KYTC and documented in the *Feasibility and Constructability Study of the Replacement/Rehabilitation of the Brent Spence Bridge* (May 2005). This report recommended six conceptual alternatives for further study.

In 2006, 25 conceptual alternatives including the No Build Alternative, and the six conceptual alternatives from the KYTC study, were developed as part of Step 4 of the ODOT PDP. These 25 conceptual alternatives were evaluated using a two-phased comparative analysis screening process which eliminated 19 of the 25 conceptual alternatives from further study and evaluation. The results of the conceptual alternatives considered and dismissed are presented in the *Planning Study Report* (September 2006). At the end of Step 4, a total of six conceptual alternatives were recommended for further study in Step 5 of the PDP. These alternatives included the No Build Alternative and five mainline build alternatives:

- Mainline Alternative 1 - Queensgate Alignment for I-75
- Mainline Alternative 2 - Queensgate Alignment for I-71/I-75
- Mainline Alternative 3 - New Bridge Just West for I-75
- Mainline Alternative 4 - New Bridge Just West for all Traffic
- Mainline Alternative 5 - Construct New Bridges for I-75

The No Build Alternative maintains the existing configuration of the I-71/I-75 corridor and consists of minor, short-term safety and maintenance improvements to the interstate, which would maintain its continuing operation. The No Build Alternative is retained as a baseline for evaluation of the build alternatives.

### **Step 5 Conceptual Alternatives**

The five conceptual build alternatives and sub-alternatives were further developed in more detail and refined during Step 5 of the PDP. These efforts included environmental studies, traffic analysis, refinement of horizontal and vertical alignments, cost estimates, utilities coordination, and stakeholder coordination. As a result, the mainline alternatives and sub-alternatives evolved into eight conceptual alternatives. The eight conceptual alternatives were identified as Alternatives A through H and are defined and analyzed in this report.

- Alternative A (Alternative 1, I-71/US 50 Interchange Sub-Alternative 1, Hybrid of Collector-Distributor Roads Sub-Alternative 1 and Arterial Improvements Sub-Alternative 2 from the *Planning Study Report*)
- Alternative B (Alternative 2, I-71/US 50 Interchange Sub-Alternative 2, Hybrid of Collector-Distributor Roads Sub-Alternative 1 and Arterial Improvements Sub-Alternative 2 from the *Planning Study Report*)
- Alternative C (Variation of Alternative 3, I-71/I-75/US 50 Interchange Sub-Alternative, 1, Hybrid of Collector-Distributor Roads Sub-Alternative 1 and Arterial Improvements Sub-Alternative 2 from the *Planning Study Report*)



- Alternative D (Variation of Alternative 3, I-71/I-75/US 50 Interchange Sub-Alternative 3, Hybrid of Collector-Distributor Roads Sub-Alternative 1 and Arterial Improvements Sub-Alternative 2 from the *Planning Study Report*)
- Alternative E (Variation of Alternative 3, I-71/I-75/US 50 Interchange Sub-Alternative 3, Hybrid of Collector-Distributor Roads Sub-Alternative 1 and Arterial Improvements Sub-Alternative 2 from the *Planning Study Report*)
- Alternative F (Variation of Alternative 4, I-71/I-75/US 50 Interchange Sub-Alternative 2, Hybrid of Collector-Distributor Roads Sub-Alternative 1 and Arterial Improvements Sub-Alternative 2 from the *Planning Study Report*)
- Alternative G (Variation of Alternative 4, I-71/I-75/US 50 Interchange Sub-Alternative 3, Hybrid of Collector-Distributor Roads Sub-Alternative 1 and Arterial Improvements Sub-Alternative 2 from the *Planning Study Report*)
- Alternative H (Alternative 5 from the *Planning Study Report*)

The comparative analysis of the eight conceptual alternatives eliminated some of the alternatives, including Alternatives A, F, and H. Alternatives A and H were eliminated from further consideration due to fatal flaws, which were identified as the alternatives were developed in more detail. Alternative F was eliminated from further consideration because it was very similar to Alternative G and did not provide any additional benefit. Alternatives evaluated throughout Step 5 were Alternatives B, C, D, E, and G. The five alternatives, examined in detail in this report, then were compared for their ability to meet the project's purpose and need, impacts, constructability, and estimated costs. Impacts were determined using the construction limits of each alternative.

The conceptual alternatives developed and evaluated in Step 5 all have comparable impacts at both the southern and northern ends of the study area. Distinction among the alternatives is made by evaluating the impacts of each within the Central Business Districts (CBD) and adjacent communities of both Covington, Kentucky and Cincinnati, Ohio. The difference between the conceptual alternatives is the area between the limits of KY 12<sup>th</sup> Street and Ezzard Charles Drive. Alternative B, the "Queensgate alignment" is west of Longworth Hall (a Section 4(f) resource) through the Queensgate area. Alternatives C, D, E, and G, "Existing alignment," are all alignment variations which follow the existing interstate corridor. Among these alternatives, access to both CBD areas varies from providing direct access via new interchanges with I-71/I-75 to providing CBD access with a system of collector-distributor (C-D) roadways that connect to CBD access points.

Based on the adverse impacts to communities and property acquisition associated with Alternative B, as well as the overall complexity, constructability, risk, and cost, it is recommended that Alternative B be eliminated from further consideration.

Alternatives C and D are very similar in overall design. Based on the comparative analysis with respect to horizontal and vertical alignments, impacts, and the flow of traffic of Alternatives C and D, it is recommended that a hybrid alternative of the northbound portion of Alternative C and the southbound portion of Alternative D should be advanced for further consideration.

Alternative G is recommended to be eliminated from further consideration due to the high costs of this alternative and the higher property acquisition associated with it. Alternative G would result in 31 residential and 41 business displacements. The

business displacements would affect over 1,300 employees. However, the following beneficial design features of Alternative G will be carried forward for further analysis and incorporated into the feasible alternatives:

- access to north end of Clay Wade Bailey Bridge from I-75 southbound using a C-D roadway and US 50 eastbound;
- two access points into Covington;
- access from a northbound C-D roadway from KY to I-71 northbound in Ohio; and
- access ramp just north of Ezzard Charles Drive for Freeman Ave and local traffic to I-75 northbound.

**Recommended Feasible Alternatives**

The comparative analysis led to the recommendation of carrying forward two feasible alternatives. The two feasible alternatives consist of Alternative E and a combination of Alternatives C and D. Based on the analyses completed and feedback as part of community input, it is also recommended that certain design elements (as listed above) of Alternative G be incorporated into the two feasible alternatives in Step 6 of the PDP. Additionally, the two feasible alternatives will be designed to provide three lanes in each direction on I-75.

Summary Comparison of Conceptual Alternatives						
Impacts	No Build	Alternative B (Former Alternative 2)	Alternative C (Former Alternative 3)	Alternative D (Former Alternative 3)	Alternative E (Former Alternative 3)	Alternative G (Former Alternative 4 Hybrid)
<b>Alternative Description</b>	The No Build Alternative consists of minor, short-term safety and maintenance improvements to the Brent Spence Bridge and I-75 corridor, which would maintain continuing operations. All within existing right of way.	Six lanes each direction between Kyles Lane to KY 12 <sup>th</sup> Street; Local C-D roadway from KY 12 <sup>th</sup> Street to Ohio River; New bridge (4 lanes in each direction) through Queensgate 900 feet west of existing for I-71/I-75 traffic; Rehab existing bridge for local traffic (2 lanes SB and 3 lanes NB); Realign US 50; Improvements to Western and Winchell Avenues	Six lanes in each direction between Kyles Lane and KY 12 <sup>th</sup> Street; local C-D roadway from KY 12 <sup>th</sup> Street to Ohio River; New double deck bridge just west of existing bridge for I-75 (2 lanes NB and SB), 2 lanes SB I-71, two lanes SB local traffic; Rehab existing bridge for NB I-71 (2 lanes), NB local traffic (3 lanes); Reconfigure I-75 through I-71/I-75/US 50 Interchange; From KY 12 <sup>th</sup> Street to Ezzard Charles Drive NB I-75 5 lanes, SB I-75 2 lanes, and local SB C-D roadway 4 lanes; Improvements to Western and Winchell Avenues	Six lanes in each direction between Kyles Lane and KY 12 <sup>th</sup> Street; Local C-D roadway between KY 12 <sup>th</sup> Street and the Ohio River; New double deck bridge just west of the existing bridge I-75 (2 lanes NB and SB), two lanes SB I-71, and two lanes SB local traffic; Rehab existing bridge for NB I-71 (2 lanes) and three lanes for NB local traffic (3 lanes); Reconfigure I-75 through the I-71/I-75/US 50 Interchange; 11 lanes for I-75 and SB local traffic between Ezzard Charles Drive and the Western Hills Viaduct; Improvements to Western and Winchell Avenues	Six lanes in each direction between Kyles Lane and KY 12 <sup>th</sup> Street; Two access points into Covington for both NB and SB traffic; New double-deck bridge just west of the existing Bridge for I-71/I-75 traffic (2 lanes in each direction); Reconfigure I-75 through the I-71/I-75/US 50 Interchange; Between Ezzard Charles Drive and Western Hills Viaduct, SB I-75 6 lanes, NB I-75 5 lanes, and one auxiliary lane to the Western Hills Viaduct; Improvements to Western and Winchell Avenues	Six lanes in each direction between Kyles Lane and KY 12 <sup>th</sup> Street; 2 access points to Covington for NB and SB traffic through a C-D roadway; New double deck bridge just west of the existing bridge for I-75 (2 lanes in each direction), 2 lanes for SB I-71 and 2 lanes for SB local traffic; Rehab existing bridge for NB I-71 (2 lanes) and local traffic (3 lanes); Reconfigure I-75 through the I-71/I-75/US 50 Interchange; I-75 elevated from Ohio River to Linn Street; NB C-D roadway will carry local traffic to Ezzard Charles Drive; Improvements to Western and Winchell Avenues
<b>Purpose and Need Elements</b>						
Improve traffic flow and level of service	<ul style="list-style-type: none"> <li>Does not improve traffic flow and level of service</li> <li>congestion will continue to worsen</li> </ul>	Improves traffic and level of service over the No Build	Improves traffic and level of service over the No Build	Improves over the No Build	Improves traffic and level of service over the No Build	Improves traffic and level of service over the No Build
Improve safety	Will not improve safety	Improves safety <ul style="list-style-type: none"> <li>Separates local and interstate traffic to help reduce accident rates</li> </ul>	Improves safety <ul style="list-style-type: none"> <li>Lower design speed for local C-D roadway help reduce accident rates</li> </ul>	Improves safety <ul style="list-style-type: none"> <li>Improves geometry on I-75 to help reduce accident rates</li> </ul>	Improves safety <ul style="list-style-type: none"> <li>Provides proper shoulder widths to help reduce accident rates</li> </ul>	Improves safety <ul style="list-style-type: none"> <li>Improved geometries help reduce accident rates</li> </ul>
Correct geometric deficiencies	Will not correct geometric deficiencies	Corrects geometric deficiencies with design exceptions	Corrects geometric deficiencies with design exceptions	Corrects geometric deficiencies with design exceptions	Corrects geometric deficiencies with design exceptions	Corrects geometric deficiencies with design exceptions
Maintain and improve connections to local, regional, and national transportation corridors	Maintains but does not improve existing connections	Changes and improves connections	Does not maintain all existing connections	Does not maintain all existing connections	Maintains and improves connections	Removes some local connections
<b>Engineering</b>						
Provides local access to/from the interstate	Provides local access to/from the interstate as it currently exists	Provides access to interstate by way of local C-D road <ul style="list-style-type: none"> <li>I-75 access between KY 12<sup>th</sup> Street and Ezzard Charles Drive</li> </ul> Provides direct access to interstate <ul style="list-style-type: none"> <li>1 direct access point to I-71 NB in KY at Pike Street</li> </ul>	Provides access to interstate by way of local C-D road <ul style="list-style-type: none"> <li>I-75 access between KY 12<sup>th</sup> Street and Ezzard Charles Drive</li> </ul> Provides direct access to interstate <ul style="list-style-type: none"> <li>1 direct access point to I-71 NB in KY at Pike Street</li> </ul>	Provides indirect access to interstate by way of local C-D road <ul style="list-style-type: none"> <li>I-75 access between KY 12<sup>th</sup> Street and Ezzard Charles Drive</li> </ul> Provides direct access to interstate <ul style="list-style-type: none"> <li>1 direct access point to I-71 NB at KY 9<sup>th</sup> Street</li> </ul>	Provides indirect access to interstate by way of local C-D road <ul style="list-style-type: none"> <li>I-75 access KY 12<sup>th</sup> Street and Ezzard Charles Drive</li> </ul> Provides direct access to interstate <ul style="list-style-type: none"> <li>1 direct access point to I-71 NB in KY</li> <li>1 direct access point to I-75 NB in KY</li> <li>Direct access to I-71/I-75 SB in KY at 5<sup>th</sup> Street</li> </ul>	Provides indirect access to interstate by way of local C-D road <ul style="list-style-type: none"> <li>I-75 access KY 12<sup>th</sup> Street and Ezzard Charles Drive</li> </ul> Provides direct access to interstate <ul style="list-style-type: none"> <li>1 direct access point to I-71 NB at KY 9<sup>th</sup> Street</li> </ul>

Summary Comparison of Conceptual Alternatives						
Impacts	No Build	Alternative B (Former Alternative 2)	Alternative C (Former Alternative 3)	Alternative D (Former Alternative 3)	Alternative E (Former Alternative 3)	Alternative G (Former Alternative 4 Hybrid)
<b>Alternative Description</b>	The No Build Alternative consists of minor, short-term safety and maintenance improvements to the Brent Spence Bridge and I-75 corridor, which would maintain continuing operations. All within existing right of way.	Six lanes each direction between Kyles Lane and KY 12 <sup>th</sup> Street; Local C-D roadway from KY 12 <sup>th</sup> Street to Ohio River; New bridge (4 lanes in each direction) through Queensgate 900 feet west of existing for I-71/I-75 traffic; Rehab existing bridge for local traffic (2 lanes SB and 3 lanes NB); Realign US 50; Improvements to Western and Winchell Avenues	Six lanes in each direction between Kyles Lane and KY 12 <sup>th</sup> Street; local C-D roadway from KY 12 <sup>th</sup> Street to Ohio River; New double deck bridge just west of existing bridge for I-75 (2 lanes NB and SB), 2 lanes SB I-71, two lanes SB local traffic; Rehab existing bridge for NB I-71 (2 lanes), NB local traffic (3 lanes); Reconfigure I-75 through I-71/I-75/US 50 Interchange; From KY 12 <sup>th</sup> Street to Ezzard Charles Drive NB I-75 5 lanes, SB I-75 2 lanes, and local SB C-D roadway 4 lanes; Improvements to Western and Winchell Avenues	Six lanes in each direction between Kyles Lane and KY 12 <sup>th</sup> Street; Local C-D roadway between KY 12 <sup>th</sup> Street and the Ohio River; New double deck bridge just west of the existing bridge I-75 (2 lanes NB and SB), two lanes SB I-71, and two lanes SB local traffic; Rehab existing bridge for NB I-71 (2 lanes) and three lanes for NB local traffic (3 lanes); Reconfigure I-75 through the I-71/I-75/US 50 Interchange; 11 lanes for I-75 and SB local traffic between Ezzard Charles Drive and the Western Hills Viaduct; Improvements to Western and Winchell Avenues	Six lanes in each direction between Kyles Lane and KY 12 <sup>th</sup> Street; Two access points into Covington for both NB and SB traffic; New double-deck bridge just west of the existing Bridge for I-71/I-75 traffic (2 lanes in each direction); Reconfigure I-75 through the I-71/I-75/US 50 Interchange; Between Ezzard Charles Drive and Western Hills Viaduct, SB I-75 6 lanes, NB I-75 5 lanes, and one auxiliary lane to the Western Hills Viaduct; Improvements to Western and Winchell Avenues	Six lanes in each direction between Kyles Lane and KY 12 <sup>th</sup> Street; 2 access points to Covington for NB and SB traffic through a C-D roadway; New double deck bridge just west of the existing bridge for I-75 (2 lanes in each direction), 2 lanes for SB I-71 and 2 lanes for SB local traffic; Rehab existing bridge for NB I-71 (2 lanes) and local traffic (3 lanes); Reconfigure I-75 through the I-71/I-75/US 50 Interchange; I-75 elevated from Ohio River to Linn Street; NB C-D roadway will carry local traffic to Ezzard Charles Drive; Improvements to Western and Winchell Avenues
<b>Engineering</b>						
Provides direct access to Covington from I-75	Provides direct local access to/from the I-75 as it currently exists	Provides indirect access to Covington from I-75 by a C-D road <ul style="list-style-type: none"> <li>NB access at KY 12<sup>th</sup> Street</li> <li>SB access at KY 9<sup>th</sup> Street</li> </ul>	Provides indirect access to Covington from I-75 by a C-D road <ul style="list-style-type: none"> <li>NB access at KY 12<sup>th</sup> Street</li> <li>SB access at KY 9<sup>th</sup> Street</li> </ul>	Provides indirect access to Covington from I-75 by a C-D road <ul style="list-style-type: none"> <li>NB access at KY 12<sup>th</sup> Street</li> <li>SB access at KY 9<sup>th</sup> Street</li> </ul>	Provides direct access to Covington <ul style="list-style-type: none"> <li>SB I-75 and SB I-71 access at KY 9<sup>th</sup> NB traffic</li> </ul> Provides indirect access to Covington by C-D road <ul style="list-style-type: none"> <li>Access at KY 12<sup>th</sup> Street</li> </ul>	Provides indirect access to Covington by C-D road <ul style="list-style-type: none"> <li>NB access at KY 12<sup>th</sup> and KY 5<sup>th</sup> streets</li> <li>SB access at KY 5<sup>th</sup> and KY 9<sup>th</sup> streets</li> </ul>
Maintains existing access points to I-75 in Cincinnati	Maintains local access to/from I-75 as it currently exists	Maintains local access to/from the interstate as it currently exists	Eliminates direct access to/from I-75; Access provided by C-D road <ul style="list-style-type: none"> <li>I-75 NB access eliminated between KY 12<sup>th</sup> Street to just south of Ezzard Charles Drive</li> <li>I-75 SB access eliminated between KY 9<sup>th</sup> Street and the Western Hills Viaduct</li> <li>Access provided by C-D road</li> </ul>	Eliminates direct access to/from I-75; Access provided by C-D road <ul style="list-style-type: none"> <li>I-75 NB access eliminated between KY 12<sup>th</sup> Street to just south of Ezzard Charles Drive</li> <li>I-75 SB access eliminated between KY 9<sup>th</sup> Street and the Western Hills Viaduct</li> <li>Access provided by C-D road</li> </ul>	Alters existing access to I-75 <ul style="list-style-type: none"> <li>Existing I-75 NB and SB access eliminated or reconfigured between KY 12<sup>th</sup> Street to just north of Ezzard Charles</li> <li>Existing direct access to/from I-75 will remain but reconfigured at US 50</li> </ul>	Eliminates direct access to/from I-75 <ul style="list-style-type: none"> <li>I-75 NB access eliminated between KY 12<sup>th</sup> Street to just north of Ezzard Charles Drive</li> <li>I-75 SB access between KY 9<sup>th</sup> Street and the Western Hills Viaduct</li> </ul>
Separates local and regional traffic	Does not separate Interstate system as it currently exists	Separates local and regional traffic <ul style="list-style-type: none"> <li>A new bridge for I-71/I-75 traffic will be constructed through Queensgate</li> <li>Existing Brent Spence Bridge will be rehabilitated to carry local NB and SB traffic.</li> </ul>	Separates local and regional traffic <ul style="list-style-type: none"> <li>A new bridge just west of the existing Brent Spence Bridge will be constructed to carry I-75 NB and SB, I-71 SB, and local SB traffic</li> <li>Existing Brent Spence Bridge will be rehabilitated to carry I-71 NB and local NB traffic.</li> </ul>	Separates local and regional traffic <ul style="list-style-type: none"> <li>A new bridge just west of the existing Brent Spence Bridge will be constructed to carry I-75 and I-71 NB and SB traffic</li> <li>The existing Brent Spence Bridge will be rehabilitated to carry local NB and SB traffic.</li> </ul>	Separates local and regional traffic <ul style="list-style-type: none"> <li>A new bridge just west of the existing Brent Spence Bridge will be constructed to carry I-75 NB and SB, I-71 SB, and local SB traffic</li> <li>The existing Brent Spence Bridge will be rehabilitated to carry I-71 NB and local NB traffic.</li> </ul>	Separates local and regional traffic <ul style="list-style-type: none"> <li>A new bridge just west of the existing Brent Spence Bridge will be constructed to carry I-75 NB and SB, I-71 SB, and local SB traffic</li> <li>The existing Brent Spence Bridge will be rehabilitated to carry I-71 NB and local NB traffic.</li> </ul>

Summary Comparison of Conceptual Alternatives						
Impacts	No Build	Alternative B (Former Alternative 2)	Alternative C (Former Alternative 3)	Alternative D (Former Alternative 3)	Alternative E (Former Alternative 3)	Alternative G (Former Alternative 4 Hybrid)
<b>Alternative Description</b>	The No Build Alternative consists of minor, short-term safety and maintenance improvements to the Brent Spence Bridge and I-75 corridor, which would maintain continuing operations. All within existing right of way.	Six lanes each direction between Kyles Lane to KY 12 <sup>th</sup> Street; Local C-D roadway from KY 12 <sup>th</sup> Street to Ohio River; New bridge (4 lanes in each direction) through Queensgate 900 feet west of existing for I-71/I-75 traffic; Rehab existing bridge for local traffic (2 lanes SB and 3 lanes NB); Realign US 50; Improvements to Western and Winchell Avenues	Six lanes in each direction between Kyles Lane and KY 12 <sup>th</sup> Street; local C-D roadway from KY 12 <sup>th</sup> Street to Ohio River; New double deck bridge just west of existing bridge for I-75 (2 lanes NB and SB), 2 lanes SB I-71, two lanes SB local traffic; Rehab existing bridge for NB I-71 (2 lanes), NB local traffic (3 lanes); Reconfigure I-75 through I-71/I-75/US 50 Interchange; From KY 12 <sup>th</sup> Street to Ezzard Charles Drive NB I-75 5 lanes, SB I-75 2 lanes, and local SB C-D roadway 4 lanes; Improvements to Western and Winchell Avenues	Six lanes in each direction between Kyles Lane and KY 12 <sup>th</sup> Street; Local C-D roadway between KY 12 <sup>th</sup> Street and the Ohio River; New double deck bridge just west of the existing bridge I-75 (2 lanes NB and SB), two lanes SB I-71, and two lanes SB local traffic; Rehab existing bridge for NB I-71 (2 lanes) and three lanes for NB local traffic (3 lanes); Reconfigure I-75 through the I-71/I-75/US 50 Interchange; 11 lanes for I-75 and SB local traffic between Ezzard Charles Drive and the Western Hills Viaduct; Improvements to Western and Winchell Avenues	Six lanes in each direction between Kyles Lane and KY 12 <sup>th</sup> Street; Two access points into Covington for both NB and SB traffic; New double-deck bridge just west of the existing Bridge for I-71/I-75 traffic (2 lanes in each direction); Reconfigure I-75 through the I-71/I-75/US 50 Interchange; Between Ezzard Charles Drive and Western Hills Viaduct, SB I-75 6 lanes, NB I-75 5 lanes, and one auxiliary lane to the Western Hills Viaduct; Improvements to Western and Winchell Avenues	Six lanes in each direction between Kyles Lane and KY 12 <sup>th</sup> Street; 2 access points to Covington for NB and SB traffic through a C-D roadway; New double deck bridge just west of the existing bridge for I-75 (2 lanes in each direction), 2 lanes for SB I-71 and 2 lanes for SB local traffic; Rehab existing bridge for NB I-71 (2 lanes) and local traffic (3 lanes); Reconfigure I-75 through the I-71/I-75/US 50 Interchange; I-75 elevated from Ohio River to Linn Street; NB C-D roadway will carry local traffic to Ezzard Charles Drive; Improvements to Western and Winchell Avenues
<b>Environmental Resources</b>						
Ohio River – (new bridge crossings and new piers)	None	Less than 10% of the piers will be in the river	New bridge located 120 feet west of existing bridge; Two new piers located in the river			
<b>Cultural Resources</b>						
Individual properties eligible for listing or listed in the National Register of Historic Places (NRHP)	No Impacts	3 Properties: 3 potentially eligible properties: • Residence at 632 Western Avenue direct impact • Residence at 521 Western Avenue potential visual and noise impacts • Residence at 881 Highway Avenue potential visual and noise impacts	2 Properties: 1 Potentially eligible property: • Harriet Beecher Stowe Elementary School potential visual and noise impacts  1 NRHP Listed: • Longworth Hall direct impact (0.25 acres and eastern portion of building)	2 Properties: 1 Potentially eligible property: • Harriet Beecher Stowe Elementary School potential visual and noise impacts  1 NRHP Listed: • Longworth Hall direct impact (0.25 acres and eastern portion of building)	2 Properties: 1 Potentially eligible property: • Harriet Beecher Stowe Elementary School potential visual and noise impacts  1 NRHP Listed: • Longworth Hall direct impact (0.54 acres and eastern portion of building)	2 Properties: 1 Potentially eligible property: • Harriet Beecher Stowe Elementary School potential visual and noise impacts  1 NRHP Listed: • Longworth Hall direct impact (0.42 acres and eastern portion of building)
Historic Districts (HD) directly impacted	No Impacts	2.4 acres impacted of NRHP Listed Lewisburg HD	0.83 acres impacted of NRHP Listed Lewisburg HD	0.88 acres impacted of NRHP Listed Lewisburg HD	0.98 acres impacted of NRHP Listed Lewisburg HD	2.9 acres impacted of NRHP Listed Lewisburg HD
<b>Community Resources</b>						
Community Cohesion	No Impact	<ul style="list-style-type: none"> <li>Loss of homes and local businesses on Crescent Avenue in West Covington neighborhood</li> <li>Loss of 8 homes in the Lewisburg neighborhood and Historic District adjacent to I-71/I-75</li> <li>Traverses the Queensgate business district</li> <li>Residents displaced near Western Hills Viaduct</li> </ul>	<ul style="list-style-type: none"> <li>Loss of homes in the Lewisburg neighborhood</li> <li>Residents displaced near Western Hills Viaduct</li> </ul>	<ul style="list-style-type: none"> <li>Loss of homes in the Lewisburg neighborhood</li> <li>Residents displaced near Western Hills Viaduct</li> </ul>	<ul style="list-style-type: none"> <li>Loss of homes in the Lewisburg neighborhood</li> <li>Residents displaced near Western Hills Viaduct</li> </ul>	<ul style="list-style-type: none"> <li>Loss of homes and local businesses on Crescent Avenue in West Covington neighborhood</li> <li>Loss of 12 homes in the Lewisburg neighborhood and Historic District adjacent to I-71/I-75</li> <li>Residents displaced near Western Hills Viaduct</li> </ul>

Summary Comparison of Conceptual Alternatives						
Impacts	No Build	Alternative B (Former Alternative 2)	Alternative C (Former Alternative 3)	Alternative D (Former Alternative 3)	Alternative E (Former Alternative 3)	Alternative G (Former Alternative 4 Hybrid)
<b>Alternative Description</b>	The No Build Alternative consists of minor, short-term safety and maintenance improvements to the Brent Spence Bridge and I-75 corridor, which would maintain continuing operations. All within existing right of way.	Six lanes each direction between Kyles Lane to KY 12 <sup>th</sup> Street; Local C-D roadway from KY 12 <sup>th</sup> Street to Ohio River; New bridge (4 lanes in each direction) through Queensgate 900 feet west of existing for I-71/I-75 traffic; Rehab existing bridge for local traffic (2 lanes SB and 3 lanes NB); Realign US 50; Improvements to Western and Winchell Avenues	Six lanes in each direction between Kyles Lane and KY 12 <sup>th</sup> Street; local C-D roadway from KY 12 <sup>th</sup> Street to Ohio River; New double deck bridge just west of existing bridge for I-75 (2 lanes NB and SB), 2 lanes SB I-71, two lanes SB local traffic; Rehab existing bridge for NB I-71 (2 lanes), NB local traffic (3 lanes); Reconfigure I-75 through I-71/I-75/US 50 Interchange; From KY 12 <sup>th</sup> Street to Ezzard Charles Drive NB I-75 5 lanes, SB I-75 2 lanes, and local SB C-D roadway 4 lanes; Improvements to Western and Winchell Avenues	Six lanes in each direction between Kyles Lane and KY 12 <sup>th</sup> Street; Local C-D roadway between KY 12 <sup>th</sup> Street and the Ohio River; New double deck bridge just west of the existing bridge I-75 (2 lanes NB and SB), two lanes SB I-71, and two lanes SB local traffic; Rehab existing bridge for NB I-71 (2 lanes) and three lanes for NB local traffic (3 lanes); Reconfigure I-75 through the I-71/I-75/US 50 Interchange; 11 lanes for I-75 and SB local traffic between Ezzard Charles Drive and the Western Hills Viaduct; Improvements to Western and Winchell Avenues	Six lanes in each direction between Kyles Lane and KY 12 <sup>th</sup> Street; Two access points into Covington for both NB and SB traffic; New double-deck bridge just west of the existing Bridge for I-71/I-75 traffic (2 lanes in each direction); Reconfigure I-75 through the I-71/I-75/US 50 Interchange; Between Ezzard Charles Drive and Western Hills Viaduct, SB I-75 6 lanes, NB I-75 5 lanes, and one auxiliary lane to the Western Hills Viaduct; Improvements to Western and Winchell Avenues	Six lanes in each direction between Kyles Lane and KY 12 <sup>th</sup> Street; 2 access points to Covington for NB and SB traffic through a C-D roadway; New double deck bridge just west of the existing bridge for I-75 (2 lanes in each direction), 2 lanes for SB I-71 and 2 lanes for SB local traffic; Rehab existing bridge for NB I-71 (2 lanes) and local traffic (3 lanes); Reconfigure I-75 through the I-71/I-75/US 50 Interchange; I-75 elevated from Ohio River to Linn Street; NB C-D roadway will carry local traffic to Ezzard Charles Drive; Improvements to Western and Winchell Avenues
<b>Section 4(f) and 6(f) Resources</b>						
Section 4(f) Resources	None	5 Resources: <ul style="list-style-type: none"> <li>Goebel Park (1.86 acres)</li> <li>Lewisburg Historic District (2.4 acres; 8 residences - 1 non-contributing and 7 contributing)</li> <li>Residence at 632 Western Avenue direct impact</li> <li>Residence at 521 Western Avenue potential visual and noise impacts</li> <li>Residence at 881 Highway Avenue potential visual and noise impacts</li> </ul>	5 Resources: <ul style="list-style-type: none"> <li>Goebel Park (2.6 acres)</li> <li>Lewisburg Historic District (0.83 acres; 10 residences: 1 non-contributing; 9 contributing)</li> <li>Longworth Hall (0.25 acres)</li> <li>Harriet Beecher Stowe Elementary School potential visual and noise impacts</li> <li>Queensgate Playground (0.31 acres)</li> </ul>	5 Resources: <ul style="list-style-type: none"> <li>Goebel Park (1.94 acres)</li> <li>Lewisburg Historic District (0.88 acres) (10 residences - 1 non-contributing; 9 contributing)</li> <li>Longworth Hall (0.25 acres)</li> <li>Harriet Beecher Stowe Elementary School potential visual and noise impacts</li> <li>Queensgate Playground (0.45 acres)</li> </ul>	4 Resources: <ul style="list-style-type: none"> <li>Goebel Park (0.35 acres)</li> <li>Lewisburg Historic District (0.98 acres; 11 residences - 1 non-contributing; 10 contributing)</li> <li>Longworth Hall (0.54 acres)</li> <li>Harriet Beecher Stowe Elementary School potential visual and noise impacts</li> </ul>	5 Resources: <ul style="list-style-type: none"> <li>Goebel Park (0.78 acres)</li> <li>Lewisburg Historic District (2.9 acres; 12 residences - 2 non-contributing; 10 contributing)</li> <li>Longworth Hall (0.42 acres)</li> <li>Harriet Beecher Stowe Elementary School potential visual and noise impacts</li> <li>Queensgate Playground (0.29 acres)</li> </ul>
<b>Property Acquisition</b>						
Residential	None	42 Structures: KY – 38 (65-260 residents) OH – 5 (10-36 residents)	16 Structures: KY – 11 (13-52 residents) OH – 5 (10-36 residents)	16 Structures: KY – 11 (13-52 residents) OH – 5 (10-36 residents)	19 Structures: KY – 13 (12-48 residents) OH – 6 (11-40 residents)	31 Structures: KY – 25 (28-112 residents) OH – 6 (11-40 residents)
Business	None	34 Businesses: KY – 8 (121-158 employees) OH – 26 (1,791-1,831 employees)	35 Businesses: KY – 4 (90-115 employees) OH – 31 (242-283 employees)	34 Businesses: KY – 4 (90-115 employees) OH – 30 (164-190 employees)	39 Businesses: KY – 4 (90-115 employees) OH – 35 (327-363 employees)	41 Businesses: KY – 7 (103-140 employees) OH – 34 (1,215-1,251 employees)
Right of Way Impacts	None	72.2 Acres	22.2 Acres	19.7 Acres	22.3 Acres	28.2 Acres

Summary Comparison of Conceptual Alternatives						
Impacts	No Build	Alternative B (Former Alternative 2)	Alternative C (Former Alternative 3)	Alternative D (Former Alternative 3)	Alternative E (Former Alternative 3)	Alternative G (Former Alternative 4 Hybrid)
<b>Alternative Description</b>	The No Build Alternative consists of minor, short-term safety and maintenance improvements to the Brent Spence Bridge and I-75 corridor, which would maintain continuing operations. All within existing right of way.	Six lanes each direction between Kyles Lane to KY 12 <sup>th</sup> Street; Local C-D roadway from KY 12 <sup>th</sup> Street to Ohio River; New bridge (4 lanes in each direction) through Queensgate 900 feet west of existing for I-71/I-75 traffic; Rehab existing bridge for local traffic (2 lanes SB and 3 lanes NB); Realign US 50; Improvements to Western and Winchell Avenues	Six lanes in each direction between Kyles Lane and KY 12 <sup>th</sup> Street; local C-D roadway from KY 12 <sup>th</sup> Street to Ohio River; New double deck bridge just west of existing bridge for I-75 (2 lanes NB and SB), 2 lanes SB I-71, two lanes SB local traffic; Rehab existing bridge for NB I-71 (2 lanes), NB local traffic (3 lanes); Reconfigure I-75 through I-71/I-75/US 50 Interchange; From KY 12 <sup>th</sup> Street to Ezzard Charles Drive NB I-75 5 lanes, SB I-75 2 lanes, and local SB C-D roadway 4 lanes; Improvements to Western and Winchell Avenues	Six lanes in each direction between Kyles Lane and KY 12 <sup>th</sup> Street; Local C-D roadway between KY 12 <sup>th</sup> Street and the Ohio River; New double deck bridge just west of the existing bridge I-75 (2 lanes NB and SB), two lanes SB I-71, and two lanes SB local traffic; Rehab existing bridge for NB I-71 (2 lanes) and three lanes for NB local traffic (3 lanes); Reconfigure I-75 through the I-71/I-75/US 50 Interchange; 11 lanes for I-75 and SB local traffic between Ezzard Charles Drive and the Western Hills Viaduct; Improvements to Western and Winchell Avenues	Six lanes in each direction between Kyles Lane and KY 12 <sup>th</sup> Street; Two access points into Covington for both NB and SB traffic; New double-deck bridge just west of the existing Bridge for I-71/I-75 traffic (2 lanes in each direction); Reconfigure I-75 through the I-71/I-75/US 50 Interchange; Between Ezzard Charles Drive and Western Hills Viaduct, SB I-75 6 lanes, NB I-75 5 lanes, and one auxiliary lane to the Western Hills Viaduct; Improvements to Western and Winchell Avenues	Six lanes in each direction between Kyles Lane and KY 12 <sup>th</sup> Street; 2 access points to Covington for NB and SB traffic through a C-D roadway; New double deck bridge just west of the existing bridge for I-75 (2 lanes in each direction), 2 lanes for SB I-71 and 2 lanes for SB local traffic; Rehab existing bridge for NB I-71 (2 lanes) and local traffic (3 lanes); Reconfigure I-75 through the I-71/I-75/US 50 Interchange; I-75 elevated from Ohio River to Linn Street; NB C-D roadway will carry local traffic to Ezzard Charles Drive; Improvements to Western and Winchell Avenues
<b>Traffic</b>						
Existing (2005) levels of service and average daily traffic	Approximately 160,000 vehicles per day in project corridor  LOS range from C to F: <ul style="list-style-type: none"> <li>• 22 Segments – C</li> <li>• 19 Segments – D</li> <li>• 7 Segment – E or F (includes I-75, I-71, US 50)</li> </ul>	N/A	N/A	N/A	N/A	N/A
Future (2035) levels of service along mainline segments (NB = northbound; SB = southbound)	LOS includes I-75 <ul style="list-style-type: none"> <li>• 16 Segments – D</li> <li>• 8 Segments – E</li> <li>• 19 Segments – F</li> </ul>	I-75: <ul style="list-style-type: none"> <li>• 1 NB segment LOS F north of Dixie Highway</li> <li>• 7 SB segments LOS E</li> </ul> I-71: <ul style="list-style-type: none"> <li>• NB all segments LOS E or F</li> <li>• SB two segments LOS F</li> </ul>	I-75: <ul style="list-style-type: none"> <li>• 1 NB segment LOS F north of Dixie Highway</li> <li>• 7 SB segments LOS E</li> </ul> I-71: <ul style="list-style-type: none"> <li>• NB all segments LOS E or F</li> <li>• SB two segments LOS F</li> </ul>	I-75: <ul style="list-style-type: none"> <li>• 1 NB segment LOS E and one LOS F</li> <li>• 6 SB segments LOS E</li> </ul> I-71: <ul style="list-style-type: none"> <li>• NB all segments LOS E or F</li> <li>• SB two segments LOS F</li> </ul>	I-75: <ul style="list-style-type: none"> <li>• No NB segments LOS E or F north of Dixie Highway</li> <li>• 4 SB segments LOS E</li> </ul> I-71: <ul style="list-style-type: none"> <li>• NB all segments LOS E or F</li> <li>• SB two segments LOS F</li> </ul>	I-75: <ul style="list-style-type: none"> <li>• 1 NB segment LOS F north of Dixie Highway</li> <li>• 7 SB segments LOS E</li> </ul> I-71: <ul style="list-style-type: none"> <li>• NB all segments LOS E or F</li> <li>• SB two segments LOS</li> </ul>
Future (2035) daily hourly volumes along mainline segments (NB = northbound; SB = southbound)	I-75: <ul style="list-style-type: none"> <li>• NB ranges from 2,360 – 8,860</li> <li>• SB ranges from 2,760 – 10,170</li> </ul> I-71/I-75: <ul style="list-style-type: none"> <li>• NB ranges from 5,310-8,650</li> <li>• SB ranges from 940-9,160</li> </ul> I-71: <ul style="list-style-type: none"> <li>• NB ranges from 1,900 – 7,400</li> <li>• SB ranges from 2,420 – 6,330</li> </ul>	I-75: <ul style="list-style-type: none"> <li>• NB ranges from 2,450 – 8,790</li> <li>• SB ranges from 2,730 – 9780</li> </ul> I-71/I-75: <ul style="list-style-type: none"> <li>• NB ranges from 6,070 -8,910</li> <li>• SB ranges from 5,900 -10,390</li> </ul> I-71: <ul style="list-style-type: none"> <li>• NB ranges from 2,510 – 7,530</li> <li>• SB ranges from 2,310 – 6,490</li> </ul>	I-75: <ul style="list-style-type: none"> <li>• NB ranges from 2,450 – 9,120</li> <li>• SB ranges from 2,730 – 9,780</li> </ul> I-71/I-75: <ul style="list-style-type: none"> <li>• NB ranges from 6,010 -8,910</li> <li>• SB ranges from 5,900 -10,390</li> </ul> I-71: <ul style="list-style-type: none"> <li>• NB ranges from 2,260 – 7,530</li> <li>• SB ranges from 2,310 – 6,490</li> </ul>	I-75: <ul style="list-style-type: none"> <li>• NB ranges from 2,450 – 9,020</li> <li>• SB ranges from 2,730 – 9,840</li> </ul> I-71/I-75: <ul style="list-style-type: none"> <li>• NB ranges from 6,070 -8,910</li> <li>• SB ranges from 5,900 -10,390</li> </ul> I-71: <ul style="list-style-type: none"> <li>• NB ranges from 2,260 – 7,530</li> <li>• SB ranges from 2,310 – 6,490</li> </ul>	I-75: <ul style="list-style-type: none"> <li>• NB ranges from 2,870 – 8,680;</li> <li>• SB ranges from 2,730 – 9,480</li> </ul> I-71/I-75: <ul style="list-style-type: none"> <li>• NB ranges from 6,440 – 8,910;</li> <li>• SB ranges from 6,460 – 10,390</li> </ul> I-71: <ul style="list-style-type: none"> <li>• NB ranges from 2,240 – 7,530;</li> <li>• SB ranges from 2,500 – 6,660</li> </ul>	I-75: <ul style="list-style-type: none"> <li>• NB ranges from 2,450 – 9,280</li> <li>• SB ranges from 2,730 – 9820</li> </ul> I-71/I-75: <ul style="list-style-type: none"> <li>• NB ranges from 5,640 – 8,910</li> <li>• SB ranges from 5,900 – 10,390</li> </ul> I-71: <ul style="list-style-type: none"> <li>• NB ranges from 2,240 – 7,530</li> <li>• SB ranges from 2,310 – 6,490</li> </ul>

Summary Comparison of Conceptual Alternatives						
Impacts	No Build	Alternative B (Former Alternative 2)	Alternative C (Former Alternative 3)	Alternative D (Former Alternative 3)	Alternative E (Former Alternative 3)	Alternative G (Former Alternative 4 Hybrid)
<b>Alternative Description</b>	The No Build Alternative consists of minor, short-term safety and maintenance improvements to the Brent Spence Bridge and I-75 corridor, which would maintain continuing operations. All within existing right of way.	Six lanes each direction between Kyles Lane to KY 12 <sup>th</sup> Street; Local C-D roadway from KY 12 <sup>th</sup> Street to Ohio River; New bridge (4 lanes in each direction) through Queensgate 900 feet west of existing for I-71/I-75 traffic; Rehab existing bridge for local traffic (2 lanes SB and 3 lanes NB); Realign US 50; Improvements to Western and Winchell Avenues	Six lanes in each direction between Kyles Lane and KY 12 <sup>th</sup> Street; local C-D roadway from KY 12 <sup>th</sup> Street to Ohio River; New double deck bridge just west of existing bridge for I-75 (2 lanes NB and SB), 2 lanes SB I-71, two lanes SB local traffic; Rehab existing bridge for NB I-71 (2 lanes), NB local traffic (3 lanes); Reconfigure I-75 through I-71/I-75/US 50 Interchange; From KY 12 <sup>th</sup> Street to Ezzard Charles Drive NB I-75 5 lanes, SB I-75 2 lanes, and local SB C-D roadway 4 lanes; Improvements to Western and Winchell Avenues	Six lanes in each direction between Kyles Lane and KY 12 <sup>th</sup> Street; Local C-D roadway between KY 12 <sup>th</sup> Street and the Ohio River; New double deck bridge just west of the existing bridge I-75 (2 lanes NB and SB), two lanes SB I-71, and two lanes SB local traffic; Rehab existing bridge for NB I-71 (2 lanes) and three lanes for NB local traffic (3 lanes); Reconfigure I-75 through the I-71/I-75/US 50 Interchange; 11 lanes for I-75 and SB local traffic between Ezzard Charles Drive and the Western Hills Viaduct; Improvements to Western and Winchell Avenues	Six lanes in each direction between Kyles Lane and KY 12 <sup>th</sup> Street; Two access points into Covington for both NB and SB traffic; New double-deck bridge just west of the existing Bridge for I-71/I-75 traffic (2 lanes in each direction); Reconfigure I-75 through the I-71/I-75/US 50 Interchange; Between Ezzard Charles Drive and Western Hills Viaduct, SB I-75 6 lanes, NB I-75 5 lanes, and one auxiliary lane to the Western Hills Viaduct; Improvements to Western and Winchell Avenues	Six lanes in each direction between Kyles Lane and KY 12 <sup>th</sup> Street; 2 access points to Covington for NB and SB traffic through a C-D roadway; New double deck bridge just west of the existing bridge for I-75 (2 lanes in each direction), 2 lanes for SB I-71 and 2 lanes for SB local traffic; Rehab existing bridge for NB I-71 (2 lanes) and local traffic (3 lanes); Reconfigure I-75 through the I-71/I-75/US 50 Interchange; I-75 elevated from Ohio River to Linn Street; NB C-D roadway will carry local traffic to Ezzard Charles Drive; Improvements to Western and Winchell Avenues
<b>Utilities</b>						
Number of utilities impacted	None	<ul style="list-style-type: none"> <li>58 Individual facilities identified. 46 are below ground and 12 are above ground</li> <li>Does not impact the Duke Energy Sub-station near Longworth Hall</li> <li>Requires relocation of 5 high voltage transmission cables</li> </ul>	<ul style="list-style-type: none"> <li>52 Individual facilities identified. 45 are below ground and 7 are above ground</li> <li>Impacts to portion of the Duke Energy Sub-station near Longworth Hall</li> <li>Does not impact high voltage transmission cables</li> </ul>	<ul style="list-style-type: none"> <li>52 Individual facilities identified. 45 are below ground and 7 are above ground</li> <li>Impacts to portion of the Duke Energy Sub-station near Longworth Hall</li> <li>Does not impact high voltage transmission cables</li> </ul>	<ul style="list-style-type: none"> <li>52 Individual facilities identified. 45 are below ground and 7 are above ground</li> <li>Impacts to portion of the Duke Energy Sub-station near Longworth Hall</li> <li>Does not impact high voltage transmission cables</li> </ul>	<ul style="list-style-type: none"> <li>52 Individual facilities identified. 45 are below ground and 7 are above ground</li> <li>Impacts to portion of the Duke Energy Sub-station near Longworth Hall</li> <li>Does not impact high voltage transmission cables</li> </ul>
Utility relocation costs (2012 with inflation) (does not include right of way costs)	N/A	Duke Energy \$175.0 million (ranges from \$42.0 – 175.0 million)	Duke Energy \$39.4 million	Duke Energy \$39.4 million	Duke Energy \$39.4 million	Duke Energy \$39.4 million
<b>Cost Estimates (in millions)</b>						
Estimated Right of way costs (2012 with inflation)	N/A	Kentucky: \$18.4 Ohio: \$46.5 Subtotal: \$64.9	Kentucky: \$2.5 Ohio: \$15.5 Subtotal: \$18.0	Kentucky: \$2.4 Ohio: \$12.1 Subtotal: \$14.5	Kentucky: \$2.4 Ohio: \$13.0 Subtotal: \$15.4	Kentucky: \$4.6 Ohio: \$19.9 Subtotal: \$24.5
Estimated Construction Costs (2008 plus 59.5% inflation) <i>*Note: Main span bridge included in Kentucky costs</i>	N/A	Kentucky: \$1,485.4 Ohio: \$880.6 Subtotal: \$2,366.0	Kentucky: \$1,260.4 Ohio: \$752.0 Subtotal: \$2,012.4	Kentucky: \$1,260.4 Ohio: \$752.0 Subtotal: \$2,012.4	Kentucky: \$1,474.1 Ohio: \$809.3 Subtotal: \$2,283.4	Kentucky: \$1,305.3 Ohio: \$1,079.3 Subtotal: \$2,384.6
Estimated Utilities Costs (relocation and right of way costs with inflation)	N/A	Kentucky: \$91.0 Ohio: \$91.0 Subtotal: \$182.0	Kentucky: \$20.2 Ohio: \$20.2 Subtotal: \$40.4	Kentucky: \$20.2 Ohio: \$20.2 Subtotal: \$40.4	Kentucky: \$20.2 Ohio: \$20.2 Subtotal: \$40.4	Kentucky: \$20.2 Ohio: \$20.2 Subtotal: \$40.4
Project Development Costs (with inflation)	N/A	Kentucky: \$151.6 Ohio: \$92.6 Subtotal: \$244.2	Kentucky: \$130.1 Ohio: \$80.3 Subtotal: \$210.4	Kentucky: \$130.1 Ohio: \$80.3 Subtotal: \$210.4	Kentucky: \$150.5 Ohio: \$85.8 Subtotal: \$236.3	Kentucky: \$134.4 Ohio: \$111.6 Subtotal: \$246.0
Total Estimated Costs <i>*Total estimated costs include construction, real estate, utilities, utilities right of way, and project development costs</i>	N/A	Kentucky: \$1,746.4 Ohio: \$1,110.7 \$2,857.1	Kentucky: \$1,413.2 Ohio: \$868.0 \$2,281.2	Kentucky: \$1,413.1 Ohio: \$864.6 \$2,277.7	Kentucky: \$1,647.2 Ohio: \$928.3 \$2,575.5	Kentucky: \$1,464.5 Ohio: \$1,231.0 \$2,695.5



## **1.0 INTRODUCTION**

### **1.1 Project Background**

Interstate 75 (I-75) within the Greater Cincinnati/Northern Kentucky region is a major thoroughfare for local and regional mobility. Locally, it connects to I-71, I-74 and US Route 50. The Brent Spence Bridge provides an interstate connection over the Ohio River and carries both I-71 and I-75 traffic (Exhibit 1). The bridge also facilitates local travel by providing access to downtown Cincinnati, Ohio and Covington, Kentucky. Safety, congestion and geometric problems exist on the structure and its approaches. The Brent Spence Bridge, which opened to traffic in 1963, was designed to carry 80,000 vehicles per day. Currently, approximately 160,000 vehicles per day use the Brent Spence Bridge and traffic volumes are projected to increase to approximately 200,000 vehicles per day in 2035.

The I-75 corridor within the Greater Cincinnati/Northern Kentucky region is experiencing problems, which threaten the overall efficiency and flexibility of this vital trade corridor. Areas of concern include, but are not limited to, growing demand and congestion, land use pressures, environmental concerns, adequate safety margins, and maintaining linkage in key mobility, trade, and national defense highways.

The I-75 corridor has been the subject of numerous planning and engineering studies over the years and is a strategic link in the region's and the nation's highway network. As such, the Ohio Department of Transportation (ODOT) and the Kentucky Transportation Cabinet (KYTC), in cooperation with the Federal Highway Administration (FHWA), are proposing to improve the operational characteristics of I-75 and the Brent Spence Bridge in the Greater Cincinnati/Northern Kentucky region through a major transportation project.

### **1.2 Project History**

#### **1.2.1 Federal Project Designations**

The Intermodal Surface Transportation Efficiency Act of 1991 (ISTEA) identified High Priority Corridors on the National Highway System (NHS). I-75 and I-71 in Ohio are included on the priority list (Table 1).

**Table 1. Interstates 75 and 71 as Listed Under Section 1105(c)  
ISTEA (P.L. 102-240), as amended through P.L. 109-59**

<b>Item Number</b>	<b>Corridor</b>	<b>Location</b>
76	Interstate Route 75	Ohio
78	Interstate Route 71	Ohio

Source: FHWA, 2005

More recent federal surface transportation legislation (the 1998 Transportation Equity Act for the 21<sup>st</sup> Century [TEA] and the 2005 Safe, Accountable, Flexible, Efficient Transportation Equity Act: A Legacy for Users [SAFETEA-LU]), continued funding for the High Priority Corridors. Table 2 shows six of the high priority projects listed under

SAFETEA-LU that include the Brent Spence Bridge Replacement/Rehabilitation Project and adjacent projects.

**Table 2. High Priority Projects Listed Under SAFETEA-LU Located in or near the Brent Spence Bridge Replacement/Rehabilitation Project**

Item Number	State	Project Description	Amount
685	OH	Study and design of modifications to I-75 interchanges at Martin Luther King, Jr. Boulevard, Hopple Street, I-74, and Mitchell Avenue in Cincinnati	\$2.4 million
3385	KY	Replace Brent Spence Bridge, Kenton County	\$1.6 million
4217	KY	Transportation improvements to Brent Spence Bridge	\$34 million
4621	OH	On I-75 toward Brent Spence Bridge, Cincinnati	\$10 million
4623	OH	Reconstruction, widening, and interchange upgrades to I-75 between Cincinnati and Dayton	\$5 million
4624	OH	Replace the Edward N. Waldvogel Viaduct, Cincinnati, (US Route 50)	\$6 million

### 1.2.2 Kentucky Project Designations

In 1999, KYTC completed its current long-range multimodal transportation plan (Kentucky Transportation Cabinet, *Statewide Transportation Plan FY 1999–2018, December 1999*). The transportation plan is a 20-year plan for all modes of transportation. The plan consists of two phases – the short range element, which is the Six-Year Transportation Plan, and the long-range element, which is a 14-year plan beyond the six year plan. The long-range element is the principal source for new projects added to the Six-Year Transportation Plan.

KYTC initiated an engineering feasibility study to investigate replacement options for the Brent Spence Bridge in 2003. The results of this study are documented in the *Feasibility and Constructability Study of the Replacement/Rehabilitation of the Brent Spence Bridge (May 2005)*. The study area for this analysis began south of Kyles Lane in Kentucky and extended to the Western Hills Viaduct in Ohio. Concurrently, ODOT evaluated a number of alternatives for improving segments of I-75 in Ohio, from the area north of the Western Hills Viaduct, to a point north of I-275.

Kentucky’s *Recommended Six-Year Transportation Plan FY 2007-2012* lists six “Mega-Projects” that are expected to cost in excess of \$1 billion. The I-71/I-75 Brent Spence Bridge Project is one of the six “Mega-Projects”. The plan notes that the I-71/I-75 Brent Spence Bridge “is the focal point for some of the heaviest traffic volumes in Kentucky”, which not only provide a link between two major urban centers (Covington, Kentucky and Cincinnati, Ohio) but also connects the region to one of the nation’s busiest airports, the Cincinnati/Northern Kentucky International Airport located in Boone County, Kentucky.

### **1.2.3 Ohio Project Designations**

ODOT completed a statewide transportation study and strategic plan, *Access Ohio* in 1993. This plan was updated in 2004. *Access Ohio* identified "Transportation Efficiency and Economic Advancement Corridors" also known as "macro corridors" throughout the State of Ohio. These corridors are defined as "highways with statewide significance that provide connectivity to population and employment centers in Ohio and the nation by accommodating desired movements of persons and goods". The I-75 corridor is included in the list of macro corridors.

In 2000, the Ohio-Kentucky-Indiana Regional Council of Governments (OKI) and the Miami Valley Regional Planning Commission (MVRPC) formed a partnership with ODOT and KYTC to undertake a large scale analysis of the I-75 corridor. The limits of this analysis stretched from the I-71/I-75 Interchange in northern Kentucky to Piqua, Ohio. Known as the *North-South Transportation Initiative (February 2004)*, this traditional Major Investment Study (MIS) was conducted as part of the merged National Environmental Policy Act (NEPA) process. One goal of this study was to identify strategies to ensure that the I-75 corridor remains effective and efficient at moving people and goods through the region. The study addressed major improvements to all existing modes of transportation and identified appropriate transportation alternatives that need to be incorporated into the regional transportation plans. A preferred program of projects was defined based upon a thorough assessment of transportation needs and a consensus of the region's ambitions for the future.

The *North-South Transportation Initiative* recommended a number of capacity and safety improvements for the I-71 and I-75 corridor in Kentucky and I-75 in Ohio. A number of major replacements and rehabilitations were recommended for advancement into the NEPA process. One key recommendation was the Brent Spence Bridge Replacement/Rehabilitation Project (PID 75119) in order to provide for improved capacity, access, and safety in this portion of the corridor.

Two projects north of the Brent Spence Bridge were also recommended by the *North-South Transportation Initiative*. These recommendations resulted in ODOT's Thru-the-Valley project (PID 76256) and the Mill Creek Expressway (PID 76257). These two ODOT projects are being conducted as part of an overall program to improve I-75. Primary goals of this program are preserving right-of-way and assuring that short term improvements made to the corridor build on each other and provide improved capacity.

### **1.2.4 Metropolitan Planning Organization Project Designations**

The Ohio Kentucky Indiana Regional Council of Governments (OKI) is the region's MPO and is responsible for planning and programming the region's transportation improvements. The Brent Spence Replacement/Rehabilitation Project is included in OKI's 2030 Regional Transportation Plan which serves as the region's federally mandated Long Range Transportation Plan update. It is also included in the FY 2008 to FY 2011 Transportation Improvement Program (TIP). This plan lists both fiscally constrained projects and those needed but not funded taking into account currently expected funding levels. Funding for the Brent Spence Bridge Replacement/Rehabilitation Project is included the plan's fiscally-constrained list. Inclusion of the project in OKI's TIP indicates the project's eligibility for federal funding

and that it is incorporated into the Statewide Transportation Improvement Programs (STIP) in both Ohio and Kentucky.

Due to the bi-state nature of the project, funding is divided between the two states in the TIP. The Ohio portion of the TIP includes a total of \$38.83 million in Preliminary Engineering funds for Ohio bridge approaches; \$13.83 million in FY08 and \$25 million in FY10. The Kentucky portion of the TIP includes three separate project line items totaling \$38.319 million. There is \$13.319 million for design activities in fiscal years previous to 2008 and \$25 million for right-of-way and utility coordination activities in FY2009. A total of \$2.92 billion is listed as a funded line item for Kenton County, Kentucky. This line item is intended to cover construction costs for the entire project.

The OKI 2030 Regional Transportation Plan also indicates the results of its initial air quality analysis. The Brent Spence Bridge Replacement/Rehabilitation Project is included in the 2020 conformity analysis. In addition, several highway segments within the project study limits are identified in the OKI Congestion Management Process (CMP). The CMP assessed the region's transportation system performance through the collection of traffic data and an evaluation of congestion. The CMP also projected future travel conditions and developed a matrix of strategies to address future congestion levels.

Specific congestion "hot spot" segments in the project limits that were identified in the CMP are:

- I-71/I-75 in Northern Kentucky from Dixie Highway to Kyles Lane
- I-71/I-75 in Northern Kentucky from Kyles Lane to KY 12<sup>th</sup> Street in Covington
- I-71/I-75 in Northern Kentucky from KY 12<sup>th</sup> Street to KY 5<sup>th</sup> Street in Covington

The CMP identified other "hot spot" highway segments in both states, but these three specific segments were among the most congested in the region.

### **1.3 Study Area**

The project study area is located along a 7.3-mile segment of I-75 within the Commonwealth of Kentucky (state line mile 187.2) and the State of Ohio (state line mile 2.7). The study area is shown on Exhibit 2 and is 3.07 square miles in size. The southern limit of the project is 2,300 feet south of the midpoint of the Dixie Highway Interchange on I-71/I-75 in Fort Wright, Kentucky. The project limits were extended to Dixie Highway Interchange due to anticipated mainline work south through the Kyles Lane Interchange. The northern limit of the project is 1,500 feet north of the midpoint of the Western Hills Viaduct Interchange on I-75 in Cincinnati, Ohio.

The eastern and western limits of the study area generally follow the existing alignment of I-75. From the south, the study area is a 1,500-foot wide corridor centered on I-75 northward from the cities of Fort Wright and Park Hills towards the City of Covington. At Covington, the eastern and western study area boundaries widen and follow city streets as described below:

- Western project limits (from south to north):

- At KY 5<sup>th</sup> Street in the City of Covington, the western boundary extends in the northwesterly direction across the Ohio River to US 50, approximately 1,000 feet west of the Freeman Avenue Interchange.
- The western limit extends northerly parallel to Dalton Avenue to Hopkins Street.
- The western limit extends westerly along Hopkins Street to the western limits of Union Terminal, where it then extends northerly along the western limits of Union Terminal to Kenner Street.
- The western limit follows easterly along Kenner Street to the intersection with Dalton Avenue.
- The western limit parallels Dalton Avenue to north of Findlay Street, where it follows in the northerly direction with a consistent 750-foot offset from the I-75 centerline.
  
- Eastern project limits (from south to north):
  - In the City of Covington, the eastern boundary follows Philadelphia Street to its intersection with KY 5<sup>th</sup> Street.
  - The eastern boundary follows KY 5<sup>th</sup> Street to its intersection with Main Street and then follows Main Street to the Ohio River.
  - The eastern boundary parallels the Clay Wade Bailey Bridge across the Ohio River to Pete Rose Way in the City of Cincinnati.
  - Through downtown Cincinnati, the eastern boundary follows OH 2<sup>nd</sup> Street and US 50 eastbound to approximately the I-71/US 50 Interchange over Broadway Avenue, north on Broadway Avenue then westerly along OH 4<sup>th</sup> Street to Plum Street, then northward until it reaches West Court Street.
  - From West Court Street, the eastern boundary extends west to Linn Street, where it follows Linn Street to Central Parkway.
  - The eastern boundary extends north paralleling Central Parkway to Linn Street.
  - From Linn Street, the eastern boundary extends westerly to Bank Street.
  - From Bank Street, the eastern limits extend in the northerly direction with a consistent 750-foot offset from the I-75 centerline.

#### **1.4 Summary of Purpose and Need**

The Brent Spence Bridge Replacement/Rehabilitation Project will improve the operational characteristics within the I-71/I-75 corridor for both local and through traffic. In the Greater Cincinnati/Northern Kentucky region, the I-71/I-75 corridor suffers from congestion and safety-related issues as a result of inadequate capacity to accommodate current traffic demand. The complete *Purpose and Need Statement* (May 2006) is provided in Appendix F. The purpose of this project is to:

- improve traffic flow and level of service,
- improve safety,

- correct geometric deficiencies, and
- maintain connections to key regional and national transportation corridors.

The I-75 corridor is a major north-south transportation corridor through the Midwestern United States and one of the busiest freight movement (trucking) routes. Traffic volumes have increased far beyond what was originally envisioned when it was constructed in the 1950s. As a result, the I-75 corridor is characterized by poor levels of service which threaten the overall efficiency of the movement of people and goods within the region. The design features of I-71 and I-75 within the study area do not meet current standards for an interstate highway facility. A recent inventory of I-71 and I-75 within the study area, including the Brent Spence Bridge, reports numerous design deficiencies associated with lane widths, shoulder widths, left-hand exits, horizontal and vertical alignments, and horizontal and vertical clearances. The substandard design features, compounded by increasing traffic volumes, result in deteriorated operations while affecting the safety of motorists on the facility. Specific problems of I-71 and I-75 within the study area include, but are not limited to, growing demand for capacity and congestion, inadequate safety margins, and design deficiencies.

#### **1.4.1 Traffic Flow and Level of Service**

Traffic analyses completed for the *Existing and Future Conditions Report* (February 2006) and the conceptual alternatives determined that approximately 160,000 vehicles per day use the Brent Spence Bridge and traffic volumes are projected to increase to approximately 200,000 vehicles per day in 2035 for the No Build Alternative. A major cause of congestion is the inability of the interstate facility to handle current and future travel demand. If capacity improvements are not made to the I-71/I-75 corridor, the existing problems will only worsen resulting in increased travel time delays and transportation costs for motorists traveling the corridor. The complete *Existing and Future Conditions Report* (February 2006) is located in Appendix F.

The current and future levels of service (LOS) in the I-71/I-75 corridor range from LOS B to F (Appendix A). LOS is an assessment of roadway and intersection performance, expressed LOS A to F. LOS A represents free-flow conditions where vehicles are almost completely unimpeded in their ability to maneuver within the traffic stream. LOS F exceeds the roadway's capacity and there is a breakdown of vehicle flow. The desired level of service on an interstate is LOS C.

In 2005, traffic data and the level of service on I-75 for the No Build Alternative was analyzed. During the AM Peak, 48 percent of the freeway segments analyzed operated at level of service D or worse. During the PM Peak, 63 percent of the I-75 freeway segments analyzed were at level of service D or worse.

The 2035 traffic data and level of service analysis for the No Build Alternative was also conducted, for basic freeway segments on I-75. During the AM Peak, 64 percent of the freeway segments analyzed were at level of service D or worse. During the PM Peak, 95 percent of the freeway segments analyzed were at level of service D or worse. A comparison of I-75 traffic data shows significant problems for motorists, especially during the PM peak, when almost all of the freeway segments on I-75 will operate at level of service D or worse.

Freeway segments on I-71 and US 50 within the study area, were analyzed. These segments were operating under acceptable levels of service in 2005. However, many of the freeway segments will also experience conditions of poor levels of service in 2035.

Congestion problems are area wide and not limited to spot locations. These failures are occurring in both Ohio and Kentucky. The level of congestion on I-75 is the primary reason for the commuter delays and longer travel times that are currently being experienced within the corridor. As traffic builds on the interstate, points of congestion such as merges and diverges experience very high demand. The number of vehicles arriving is greater than the number of vehicles discharged. The 2035 projected peak volumes greatly exceed the capacity of the I-75 corridor.

#### **1.4.2 Safety**

Crash rates for the I-71/I-75 corridor exceed the Kentucky and Ohio statewide averages. This is due in part to congested traffic conditions in addition to deficient and substandard roadway geometry.

The I-71/I-75 corridor within Kenton County, Kentucky has a crash rate higher than the statewide average of 0.78 accidents per million vehicle miles traveled. The overall crash rate for this section is 1.30, which is nearly 1.67 times higher than Kentucky's statewide average crash rate for interstate highways.

The overall crash rate for the Ohio section of I-71 in the study area is 3.22 accidents per million vehicle miles traveled, which is approximately 1.7 times higher than the Ohio statewide average rate of 1.887 accidents per million vehicle miles traveled. Overall, I-75 within the study area has a crash rate of 2.91, which is approximately 1.5 times higher than the statewide average rate.

The number of crashes for specific sections, within the I-75 corridor, from 2005 to 2007 is shown in Exhibit 3. The crashes are color coded and are compiled in 0.1 mile sections. The most prevalent accident types in the study area are rear end, sideswipe and fixed object crashes. In Ohio, the highest concentration of accidents is in the section of I-75 from Eighth Street to Findlay Street. Within this 1.1 mile section of interstate, there were more than 30 accidents per .1 mile of interstate. The next section of roadway where accidents were heavily concentrated was the section of I-75 from Findlay Street to 1500 feet north of the Western Hills Viaduct. In this section of I-75 there were .3 miles of interstate that had 21 to 30 crashes per .1 miles of interstate and a .4 mile section of interstate, where there were more than 30 accidents per .1 mile of interstate.

In Kentucky, accidents such as rear ends, sideswipes and fixed object crashes were concentrated on I-75 from about 2000 feet north of the Kyles Lane Interchange to 12<sup>th</sup> Street. In this 1.5 mile section of interstate, the number of crashes per .1 mile varied, but for at least .7 miles, there were sections of interstate that had 30 or more crashes per .1 mile of interstate.

ODOT's safety management databases indicate that the I-71/I-75 corridor has been designated as a corridor with safety concerns. The ODOT Highway Safety Program (HSP) identifies and ranks all crash locations on the state system based on crash rate, frequency, density, severity, and other analytical factors. The 2005-2007 HSP list

includes two highway segments within the study area, which are ranked in the top 100, most notably, the section of I-71 from mile post 0.60 to mile post 1.10 is ranked seventh.

Both I-71 and I-75 in the study area are designated by ODOT as Safety Hot Spot Locations. These are defined as any two-mile segment of freeway with more than 250 crashes or a non-freeway location with more than 250 crashes over three years. All three highway segments within the study area rank in the top 10 statewide according to the 2005-2007 Hot Spot Freeway List. This includes HAM-IR-075R 2.22-4.22, which ranks third; HAM-IR-075R 0.22-2.22, which ranks fourth and HAM-IR-071 0.00-2.00, which ranks eighth.

At least two of the types of crashes that are occurring the most often (rear end and sideswipe accidents) could be the result of congestion. Excessive braking on the interstate can contribute to rear end crashes. Rear ends crashes could also be occurring when congestion is at high levels and drivers are moving at close to posted speeds and they come to an abrupt stop unexpectedly. Sideswipes crashes could be occurring in part from impatient drivers changing lanes frequently, due to congestion. Fixed object crashes can occur for a variety of reasons including wet pavement, dui, etc.

With traffic volumes increasing each year, an increase in crashes is expected, unless improvements along the I-75 corridor are made. A reduction in accidents is expected, if an alternative is selected that will improve roadway geometry, capacity, safety and provide better connections to local roads within the study area.

#### **1.4.3 Geometric Deficiencies**

The geometric design features of I-71 and I-75 within the study area do not meet current standards for an interstate highway facility. Design deficiencies include:

- Substandard vertical alignments with limited stopping sight distances.
- Acceleration and deceleration lanes that are not of sufficient length for anticipated traffic volumes and movements.
- Narrow shoulders that present safety hazards, make maintenance of traffic difficult, and contribute to traffic delays when crashes, vehicle breakdowns, or scheduled roadwork result in lane restrictions.

A complete list of existing geometric deficiencies is provided in the *Existing and Future Conditions Report* (February 2006). The substandard design features, compounded by increasing traffic volumes, result in deteriorated operations while affecting motorists safety on the facility. These problems will become more pervasive as traffic volumes grow. With higher traffic volumes, the potential for crashes and breakdowns (with associated lane blockages) increases. Higher volumes also increase the amount of delay experienced by drivers during any given period of lane blockage, particularly during rush hours. Traffic volumes will increase to 200,000 vehicles per day within the study area over the next 20 years.

#### **1.4.4 National, Regional, and Local System Linkage**

The I-71/I-75 corridor in the Greater Cincinnati/Northern Kentucky area is a significant transportation corridor, not only for local access and mobility needs, but also for regional, statewide and national access and mobility needs. This corridor is recognized in county



and regional transportation plans, as are the recommendations for needed improvements. In addition, I-71 and I-75 are key links in the national transportation system in terms of people movement (mobility and economic development), freight movement (commerce, economic development and international trade), and national defense. However, transportation plans and recommendations at all levels (local, state and national) recognize that these facilities now operate at or beyond capacity and therefore, need to be upgraded to modern standards to maintain these important transportation links.

## **1.5 Purpose of Report**

This Conceptual Alternatives Study is submitted in Step 5 of the ODOT Project Development Process (PDP). This report discusses the results of engineering, traffic and environmental studies completed for the conceptual alternatives. This report identifies the feasible alternatives selected for further study in Step 6 of the PDP. The Conceptual Alternatives Study is carried out under the guidelines presented in the ODOT *Location and Design Manual* (October 2006) and PDP Manual.

## **2.0 DEVELOPMENT OF CONCEPTUAL ALTERNATIVES**

### **2.1 Alternatives Considered and Dismissed**

Development of conceptual alternatives for the Brent Spence Bridge was initiated in 2003 by the Kentucky Transportation Cabinet (KYTC). These initial alternatives were documented in the *Feasibility and Constructability Study of the Replacement/Rehabilitation of the Brent Spence Bridge (Feasibility and Constructability Study* (May 2005). This report recommended a series of potential feasible build alternatives for replacement and/or rehabilitation of the Brent Spence Bridge structure and improvement to its approaches and surrounding transportation system. Six conceptual alternatives were recommended for further study.

In 2006, 25 conceptual alternatives, including the No-Build alternative, were developed in Step 4 of the Ohio Department of Transportation's (ODOT) Project Development Process (PDP). These 25 conceptual alternatives included the six alternatives from the *Feasibility and Constructability Study*. The 25 conceptual alternatives were evaluated using a two-phased screening process based on a comparative analysis. Phase one of the analysis was an evaluation of the conceptual alternatives based on the goals of the purpose and need and comments received from local governments. In phase two of the analysis, the conceptual alternatives that were not eliminated in phase one were evaluated using stakeholder goals and measures of success; design compatibility with the I-75 Mill Creek Expressway project (HAM-75-2.30) to the north; and concurrence among government agencies obtained through a series of meetings. Some alternatives were combined into hybrid alternates and then evaluated in phase two of the analysis.

The two-phased comparative analysis eliminated 19 of the 25 conceptual alternatives from further study and evaluation. These 19 conceptual alternatives failed to meet the purpose and need goals of the project and did not adequately address the stakeholder's goals and measures of success. Additionally, these alternatives would not be compatible with the I-75 Mill Creek Expressway project (HAM-75-2.30). Five travel lanes were needed to provide a seamless connection between the two projects.

The *Planning Study Report* (September 2006) documents the 25 conceptual alternatives and the two-phased comparative analysis. The *Planning Study Report* is located in Appendix F.

## **2.2 Conceptual Alternatives Recommended for Further Study**

At the end of Step 4 of the PDP, a total of six conceptual alternatives, the No Build and five mainline build alternatives were recommended for further study in Step 5 of the PDP (see *Planning Study Report* in Appendix F). The No Build Alternative was retained as a baseline for evaluation of the build alternatives. The No Build Alternative consists of minor, short-term safety and maintenance improvements to the Brent Spence Bridge and I-75 corridor, which would maintain continuing operations. The five mainline alternatives recommended for further study in the *Planning Study Report* were:

- Mainline Alternative 1 - Queensgate Alignment for I-75
- Mainline Alternative 2 - Queensgate Alignment for I-71/I-75
- Mainline Alternative 3 - New Bridge Just West for I-75
- Mainline Alternative 4 - New Bridge Just West for all Traffic
- Mainline Alternative 5 - Construct New Bridges for I-75

A variety of sub-alternatives were developed to provide options for key intersection and traffic flow areas within the project corridor (see *Planning Study Report* in Appendix F). The various sub-alternatives accommodated the design requirements of the mainline alternatives:

- I-75 Northbound at KY 12<sup>th</sup> Street Ramp Sub-Alternatives
- I-71/US 50 Interchange Sub-Alternatives (for I-75 Queensgate Alignment)
- I-71/I-75/US 50 Interchange Sub-Alternatives
- I-75 Ohio C-D Road/Arterial Improvement Sub-Alternatives
- Western Hills Viaduct Interchange Sub-Alternatives

Detailed descriptions of the mainline alternative and the various sub-alternatives are presented in the *Planning Study Report* (Appendix F). These mainline alternatives and sub-alternatives were carried forward into Step 5 for further study and refinement. The development of these alternatives is discussed in the next section.

## **2.3 Step 5 Conceptual Alternatives**

The five mainline alternatives and sub-alternatives were further developed in more detail and refined during Step 5 of the PDP. These efforts included environmental studies, traffic analysis, refinement of horizontal and vertical alignments, cost estimates, utilities coordination, and stakeholder coordination. As a result, the mainline alternatives and sub-alternatives from Step 4 as presented in the *Planning Study Report* evolved into eight conceptual alternatives. The eight conceptual alternatives are identified as Alternatives A through H:

- Alternative A (Alternative 1, I-71/US 50 Interchange Sub-Alternative 1, Hybrid of Collector-Distributor Roads Sub-Alternative 1 and Arterial Improvements Sub-Alternative 2 from the *Planning Study Report*)

- Alternative B (Alternative 2, I-71/US 50 Interchange Sub-Alternative 2, Hybrid of Collector-Distributor Roads Sub-Alternative 1 and Arterial Improvements Sub-Alternative 2 from the *Planning Study Report*)
- Alternative C (Variation of Alternative 3, I-71/I-75/US 50 Interchange Sub-Alternative, 1, Hybrid of Collector-Distributor Roads Sub-Alternative 1 and Arterial Improvements Sub-Alternative 2 from the *Planning Study Report*)
- Alternative D (Variation of Alternative 3, I-71/I-75/US 50 Interchange Sub-Alternative 3, Hybrid of Collector-Distributor Roads Sub-Alternative 1 and Arterial Improvements Sub-Alternative 2 from the *Planning Study Report*)
- Alternative E (Variation of Alternative 3, I-71/I-75/US 50 Interchange Sub-Alternative 3, Hybrid of Collector-Distributor Roads Sub-Alternative 1 and Arterial Improvements Sub-Alternative 2 from the *Planning Study Report*)
- Alternative F (Variation of Alternative 4, I-71/I-75/US 50 Interchange Sub-Alternative 2, Hybrid of Collector-Distributor Roads Sub-Alternative 1 and Arterial Improvements Sub-Alternative 2 from the *Planning Study Report*)
- Alternative G (Variation of Alternative 4, I-71/I-75/US 50 Interchange Sub-Alternative 3, Hybrid of Collector-Distributor Roads Sub-Alternative 1 and Arterial Improvements Sub-Alternative 2 from the *Planning Study Report*)
- Alternative H (Alternative 5 from the *Planning Study Report*)

A distinguishing feature of the eight conceptual alternatives is their location in Cincinnati, Ohio. The alternatives are characterized as either “Queensgate alignments”, those located west of Longworth Hall through Queensgate, or “Existing Alignments”, those located going east of Longworth Hall largely following the existing right of way. Alternatives A and B propose a new alignment west of the existing Brent Spence Bridge through the Queensgate area of Cincinnati. Alternatives C through H remain essentially within the existing I-75 corridor through Cincinnati. Alternatives A through G are shown in Exhibits 4 through 10 and are described from south to north in the following sections. Alternative H is the same as Alternative 5 from the *Planning Study Report*.

### **2.3.1 Alternative A**

Alternative A (Exhibit 4A - 4B) utilizes the existing I-71/I-75 alignment from the southern project limits at the Dixie Highway Interchange north to the Kyles Lane Interchange. The Dixie Highway and Kyles Lane interchanges will be modified slightly to accommodate a collector-distributor (C-D) road, which will be constructed along both sides of I-71/I-75 between the two interchanges. North of the Kyles Lane Interchange, the alignment shifts to the west to accommodate additional I-71/I-75 travel lanes. Between Kyles Lane and KY 12<sup>th</sup> Street, six lanes will be provided in each direction for a total of 12 travel lanes. Near KY 12<sup>th</sup> Street, Alternative A separates into two alignments, one for I-75 and the other for I-71 and a local C-D roadway network. The I-75 alignment runs along the western limits of the City of Covington between Western Avenue and Crescent Avenue. The I-71 alignment and the local C-D roadway alignment run along the existing I-71/I-75 corridor.

In Covington along the existing I-71/I-75 corridor, I-71 and the local C-D roadway are separated into two roadway networks. Access into Covington from the interstate will be provided by the local C-D roadway at KY 12<sup>th</sup> Street for northbound traffic and at KY 9<sup>th</sup> Street for southbound traffic. Access to the interstate system from Covington will be provided by the local city streets at either KY 9<sup>th</sup> Street for northbound traffic and at KY 12<sup>th</sup> Street for southbound traffic. A new double deck bridge will be built just west of the

existing Brent Spence Bridge to carry southbound I-71 and southbound local traffic. The existing Brent Spence Bridge will be rehabilitated to carry northbound I-71 and northbound local traffic.

For the I-75 alignment, a new bridge will be constructed west of the existing Brent Spence Bridge for I-75 traffic only. As part of Alternative A, either a new single-deck bridge or two twin single-deck bridges will be constructed approximately 900 feet west of the existing Brent Spence Bridge. The new I-75 alignment will pass through the Queensgate area of Cincinnati and connect to the existing I-75 corridor just south of Ezzard Charles Drive. At this point, Alternative A will follow the existing I-75 corridor to the Western Hills Viaduct. Four travel lanes, two lanes in each direction will be provided for northbound and southbound I-75 traffic.

In Ohio, Alternative A separates the I-75 mainline from the existing I-71/I-75/US 50 Interchange and realigns US 50 to provide parallel roadways. This will eliminate left-hand entrances and exits to the interstate. The ramp alignments from the existing Brent Spence Bridge to and from I-71 (Fort Washington Way) will be adjusted to make the required connections. North of the divergence of the I-71 ramps, a northbound local C-D roadway will pass through the I-71/US 50 Interchange and merge with I-75 near Ezzard Charles Drive. The southbound local C-D roadway begins just south of the Western Hills Viaduct Interchange and passes through the I-71/US 50 Interchange. Existing ramps to I-71, US 50, and downtown Cincinnati will be maintained.

Alternative A also improves Western and Winchell avenues to facilitate traffic flow and increase capacity. The ramps to Western Avenue and from Winchell Avenue just north of Ezzard Charles Drive will be removed. The northbound ramps from OH 9<sup>th</sup> Street and Freeman Avenue to I-75 will be removed, which requires traffic from these two points to utilize Winchell Avenue for access to I-75 near the Western Hills Viaduct. The Western Hills Viaduct Interchange will be reconfigured to provide a full movement interchange.

### **2.3.2 Alternative B**

Alternative B (Exhibit 5A – 5B; Appendix B Exhibit B1-A and B1-B for Cross Section Layout Plan, B6-A through B6-QQ for Roadway Cross Sections, B7-A for Main Span Bridge Cross Section) utilizes the existing I-71/I-75 alignment from the southern project limits at the Dixie Highway Interchange north to the Kyles Lane Interchange. The Dixie Highway and Kyles Lane interchanges will be modified slightly to accommodate a C-D roadway, which will be constructed along both sides of I-71/I-75 between the two interchanges. North of the Kyles Lane Interchange, the alignment shifts to the west to accommodate additional I-71/I-75 travel lanes. Between Kyles Lane and KY 12<sup>th</sup> Street, six lanes will be provided in each direction for a total of 12 travel lanes. Near KY 12<sup>th</sup> Street, Alternative B separates into two alignments, one for I-71/I-75 and the other for a local C-D roadway. The I-71/I-75 alignment runs along the western limits of the City of Covington between Western Avenue and Crescent Avenue. The local C-D roadway parallels to the existing I-71/I-75 alignment.

Access into Covington from the interstate will be provided by a local C-D roadway at KY 12<sup>th</sup> Street for northbound traffic and at KY 9<sup>th</sup> Street for southbound traffic. Access to the interstate system from Covington will be provided at Pike Street for northbound traffic via the northbound C-D roadway through downtown Cincinnati and connect south of Ezzard Charles Drive. Southbound traffic will access the interstate at KY 9<sup>th</sup> Street via

the southbound C-D roadway and also at KY 12<sup>th</sup> Street. The existing Brent Spence Bridge will be rehabilitated to carry northbound and southbound local traffic provided by the C-D roadways. Bullock Street and Jillian's Way will be extended north from Pike Street to KY 9<sup>th</sup>, 5<sup>th</sup>, 4<sup>th</sup>, and 3<sup>rd</sup> Streets. A U-turn before the KY 9<sup>th</sup> Street intersection will allow local southbound traffic to turn and travel northbound to KY 3<sup>rd</sup>, 4<sup>th</sup>, and 5<sup>th</sup> streets and another U-turn before Pike Street allowing traffic to access the northbound C-D roadway and the new I-71/I-75 bridge.

For I-71/I-75, a new bridge will be constructed west of the existing Brent Spence Bridge. Either a new single-deck bridge or two twin single-deck bridges will be constructed approximately 900 feet west of the existing Brent Spence Bridge for I-71/I-75 traffic only. In Ohio, north of Pete Rose Way, I-71 turns east to connect to Fort Washington Way. The new I-75 alignment continues north and passes through the Queensgate area of Cincinnati. It connects to the existing I-75 corridor just south of Ezzard Charles Drive and follows the existing I-75 corridor to the Western Hills Viaduct.

Alternative B separates I-71 and I-75 traffic from local traffic within the limits of downtown Cincinnati and Covington. Between KY 12<sup>th</sup> Street and the northside of the Ohio River, I-71/I-75 will consist of a total of eight lanes, four in each direction. Two lanes will be for I-71 and two lanes for I-75 in each direction. North of the Ohio River, I-71 will consist of two lanes in each direction as they reconnect to Fort Washington Way. I-75 will be two lanes from the Ohio River to Ezzard Charles Drive in the northbound direction and two lanes from the Ohio River to Western Hills Viaduct in the southbound direction. The existing Brent Spence Bridge will consist of two lanes southbound and three lanes northbound for local C-D traffic.

In Ohio, Alternative B separates the I-75 mainline from the existing I-71/I-75/US 50 Interchange and realigns US 50 to provide parallel roadways, which eliminate left-hand entrances and exits. The ramp alignments from the existing Brent Spence Bridge to and from I-71 will be adjusted to connect to existing I-71 (Fort Washington Way) through Cincinnati. North of the divergence of the I-71 ramps, the northbound local C-D roadway will pass through the I-71/US 50 Interchange and merge with I-75 near Ezzard Charles Drive to form a total of six lanes northbound. The four-lane southbound local C-D roadway begins just south of the Western Hills Viaduct Interchange and passes through the I-71/US 50 Interchange. Existing ramps to and from I-71, US 50, and downtown Cincinnati will be maintained and realigned to the local southbound C-D roadway. Traffic to southbound I-75 will use the existing Brent Spence Bridge into Covington and connect at KY 12<sup>th</sup> Street.

Alternative B also improves Western and Winchell avenues to facilitate traffic flow and increase capacity. The ramps to Western Avenue and from Winchell Avenue just north of Ezzard Charles Drive will be removed. The northbound ramps from OH 6<sup>th</sup>, Street, 9<sup>th</sup> Street, and Freeman Avenue to I-75 will be removed, which requires traffic from these three points to utilize Winchell Avenue for access to I-75 near the Western Hills Viaduct. The Western Hills Viaduct Interchange will be reconfigured to provide a full movement interchange.

### **2.3.2.1 I-71 Alignment Alternative B**

As part of the development of the I-71 alignment, several alignments were analyzed with respect to meeting design criteria, impacts to the community, and feasibility for

Alternative B. Alignments were developed for the connection from the Queensgate Alignment Bridge to existing I-71 (Fort Washington Way). Alignments were developed based on design speeds ranging from 60 miles per hour (mph) to 40 mph, in 5 mph increments. For southbound I-71 alignments above 50 mph, the impact area extended north of US 50. For northbound I-71 alignments above 50 mph, the impact area extended into the existing interchange area and into the southbound I-71 alignment. Exhibit 22 shows the preferred alignments that were developed which meet the design criteria for 50 and 45 mph design speeds. Due to the impacts of both alignments being very similar, the 50 mph alignments for both I-71 southbound and northbound were chosen as the preferred alignments and incorporated into the design of Alternative B.

### **2.3.3 Alternative C**

Alternative C (Exhibit 6A – 6B; Appendix B, Exhibit B2-A and B2-B for Cross Section Layout Plan, B6-A through B6-QQ for Roadway Cross Sections, B7-A for Main Span Bridge Cross Section) utilizes the existing I-71/I-75 alignment from the southern project limits at the Dixie Highway Interchange north to the Kyles Lane Interchange. The Dixie Highway and Kyles Lane interchanges will be modified slightly to accommodate a C-D roadway, which will be constructed along both sides of I-71/I-75 between the two interchanges. North of the Kyles Lane Interchange, the alignment shifts to the west to accommodate additional I-71/I-75 travel lanes. Between Kyles Lane and KY 12<sup>th</sup> Street, six lanes will be provided in each direction for a total of 12 travel lanes. Near KY 12<sup>th</sup> Street, the alignment separates into three routes for I-71, I-75 and a local C-D roadway.

Access into Covington from the interstate will be provided by the local C-D roadway; at KY 12<sup>th</sup> Street for northbound traffic and at KY 9<sup>th</sup> Street for southbound traffic. Direct access to I-71 from Covington will be provided at Pike Street with traffic to I-75 northbound using the C-D roadway through downtown Cincinnati and connecting at the Ezzard Charles merge. Access for southbound interstate traffic is located at KY 12<sup>th</sup> Street. Bullock Street will be extended north from Pike Street to KY 9<sup>th</sup>, 5<sup>th</sup>, and 4<sup>th</sup> streets and Jillian's Way will be extended north from Pike Street to KY 9<sup>th</sup>, 5<sup>th</sup>, 4<sup>th</sup>, and 3<sup>rd</sup> streets. A U-turn before the KY 9<sup>th</sup> Street intersection will allow local southbound traffic to turn and travel northbound to KY 3<sup>rd</sup>, 4<sup>th</sup>, and 5<sup>th</sup> streets.

A new double deck bridge will be built just west of the existing Brent Spence Bridge to carry northbound and southbound I-75 (two lanes in each direction), two lanes for southbound I-71 and two lanes for southbound local traffic. The existing Brent Spence Bridge will be rehabilitated to carry two lanes for northbound I-71 and three lanes for northbound local traffic.

Alternative C reconfigures I-75 through the I-71/I-75/US 50 Interchange and eliminates all access to and from I-75 from KY 12<sup>th</sup> Street to just south of Ezzard Charles Drive in the northbound direction. Alternative C also eliminates access to I-75 southbound between KY 9<sup>th</sup> Street and the Western Hills Viaduct. US 50 will be realigned to provide a parallel roadway and access to and from the interstate will be via the C-D roadway.

In Ohio, the northbound C-D roadway will carry local traffic from the existing bridge and provide access ramps to OH 2<sup>nd</sup> Street, US 50 westbound, and OH 5<sup>th</sup> Street before reconnecting to I-75 just south of Ezzard Charles Drive. The northbound ramps from OH 6<sup>th</sup>, 9<sup>th</sup> Streets and Freeman Avenue to I-75 will be removed requiring traffic from these three points to utilize a new local roadway parallel to the northbound C-D roadway for

access to I-75 just before Ezzard Charles Drive. The southbound C-D roadway begins after the Western Hills Viaduct Interchange and carries both downtown Covington and Cincinnati traffic. Traffic to Covington is diverted from the four-lane local C-D roadway just north of Ezzard Charles Drive and runs parallel with I-75 southbound. Access ramps from city streets to I-75 will merge with Covington traffic and travel south over the new bridge and either merge with I-71/I-75 traffic or local Kentucky city streets. Downtown Cincinnati traffic will cross over I-75 and run parallel between I-75 northbound and the northbound C-D roadway. The three-lane C-D roadway into Cincinnati will carry traffic to OH 7<sup>th</sup> Street, OH 2<sup>nd</sup> Street and I-71 northbound. Access to OH 5<sup>th</sup> Street will be removed.

Between Ezzard Charles Drive and the Western Hills Viaduct, northbound I-75 will have five lanes, southbound I-75 will have two lanes, and the local southbound C-D roadway will have four lanes, for a total of 11 travel lanes. The northbound ramps from OH 6<sup>th</sup> and 9<sup>th</sup> streets to I-75 will be removed requiring traffic from these two points to utilize a new local roadway parallel to the northbound C-D roadway for access to northbound I-75. Ramps from Freeman Avenue, Winchell Avenue just north of Ezzard Charles Drive to the Interstate, and to Western Avenue will be eliminated.

Alternative C also improves Western and Winchell avenues to facilitate traffic flow and increase capacity. The ramps to Western Avenue and from Winchell Avenue just north of Ezzard Charles Drive will be removed. The Western Hills Viaduct Interchange will be reconfigured to provide a full movement interchange.

#### **2.3.4 Alternative D**

Alternative D (Exhibit 7A – 7B; Appendix B, Exhibit B3-A and B3-B for Cross Section Layout Plan, B6-A through B7-QQ for Roadway Cross Sections, B6-A for Main Span Bridge Cross Section) utilizes the existing I-71/I-75 alignment from the southern project limits at the Dixie Highway Interchange north to the Kyles Lane Interchange. The Dixie Highway and Kyles Lane interchanges will be modified slightly to accommodate a C-D roadway, which will be constructed along both sides of I-71/I-75 between the two interchanges. North of the Kyles Lane Interchange, the alignment shifts to the west to accommodate additional I-71/I-75 travel lanes. Between Kyles Lane and KY 12<sup>th</sup> Street, six lanes will be provided in each direction for a total of 12 travel lanes. Near KY 12<sup>th</sup> Street, the alignment separates into three routes for I-71, I-75 and a local C-D roadway.

Access into Covington from the interstate will be provided by the local C-D roadway; at KY 12<sup>th</sup> Street for northbound traffic and at KY 9<sup>th</sup> Street for southbound traffic. Direct access to I-71 from Covington will be provided at KY 9<sup>th</sup> Street with traffic to I-75 northbound using the C-D roadway through downtown Cincinnati and connecting at the Ezzard Charles merge. Access for southbound interstate traffic is located at KY 12<sup>th</sup> Street. Bullock Street will be extended north from Pike Street to KY 9<sup>th</sup>, 5<sup>th</sup>, and 4<sup>th</sup> streets and Jillian's Way will be extended north from Pike Street to KY 9<sup>th</sup>, 5<sup>th</sup>, 4<sup>th</sup>, and 3<sup>rd</sup> streets. A U-turn before the KY 9<sup>th</sup> Street intersection will allow local southbound traffic to turn and travel northbound to KY 3<sup>rd</sup>, 4<sup>th</sup>, and 5<sup>th</sup> streets.

A new double deck bridge will be built just west of the existing Brent Spence Bridge to carry northbound and southbound I-75 (two lanes in each direction), two lanes for southbound I-71 and two lanes for southbound local traffic. The existing Brent Spence

Bridge will be rehabilitated to carry two lanes for northbound I-71 and three lanes for northbound local traffic.

Alternative D reconfigures I-75 through the I-71/I-75/US 50 Interchange and eliminates all access to and from I-75 from KY 12<sup>th</sup> Street to just south of Ezzard Charles Drive in the northbound direction. Alternative D also eliminates access to I-75 southbound between KY 9<sup>th</sup> Street and the Western Hills Viaduct from local routes. US 50 will be realigned, to provide a parallel roadway.

In Ohio, the local C-D roadway will be constructed along both sides of I-75. The local northbound C-D roadway will carry local traffic from the existing bridge and provide access ramps to OH 2<sup>nd</sup> Street, US 50 westbound, and OH 5<sup>th</sup> Street before reconnecting to I-75 just south of Ezzard Charles Drive. To reduce merging and weaving, the northbound C-D roadway will be split into three bridges separating the US 50/5<sup>th</sup> Street ramps from I-75 northbound and Western Hills Viaduct traffic. John Street will be redesigned as a one-way northbound local street, extending to collect traffic from OH 4<sup>th</sup> Street and merging with either the northbound C-D roadway or Winchell Avenue. The southbound C-D roadway will maintain access to I-71, downtown city streets as well as connecting to access ramps from OH 9<sup>th</sup> Street and US 50 eastbound. The C-D roadway will continue south over the new bridge into Covington.

Alternative D also improves Western and Winchell avenues to facilitate traffic flow and increase capacity. The northbound ramps from OH 6<sup>th</sup> and 9<sup>th</sup> streets to I-75 will be removed requiring traffic from these two points to utilize a new local roadway parallel to the northbound C-D roadway for access to northbound I-75. Ramps from Freeman Avenue, Winchell Avenue just north of Ezzard Charles Drive, and to Western Avenue will be eliminated.

Between Ezzard Charles Drive and the Western Hills Viaduct there will be a total of 11 travel lanes, northbound I-75 will provide five lanes, southbound I-75 will provide two lanes, and the local southbound C-D roadway will provide four lanes. The Western Hills Viaduct Interchange will be reconfigured to provide a full movement interchange.

### **2.3.5 Alternative E**

Alternative E (Exhibit 8A – 8B; Appendix B, Exhibit B4-A and B4-B for Cross Section Layout Plan, B6-A through B6-QQ for Roadway Cross Sections, B7-B for Main Span Bridge Cross Section) utilizes the existing I-71/I-75 alignment from the southern project limits at the Dixie Highway Interchange north to the Kyles Lane Interchange. The Dixie Highway and Kyles Lane interchanges will be modified slightly to accommodate a C-D roadway, which will be constructed along both sides of I-71/I-75 between the two interchanges. North of the Kyles Lane Interchange, the alignment shifts to the west to accommodate additional I-71/I-75 travel lanes. Between Kyles Lane and KY 12<sup>th</sup> Street, six lanes will be provided in each direction for a total of 12 travel lanes. Near KY 12<sup>th</sup> Street, the northbound alignment separates into two routes; one for interstate traffic and one for a local C-D roadway. Near KY 9<sup>th</sup> Street, the interstate separates into I-71 and I-75 only routes.

In Alternative E, there are two access points into Covington for both northbound and southbound traffic. In the northbound direction, access will be provided by the local C-D roadway at KY 12<sup>th</sup> Street and KY 5<sup>th</sup> Street. In the southbound direction, access will be



provided by the local C-D roadway at KY 5<sup>th</sup> Street, and off of I-71 and I-75 at KY 9<sup>th</sup> Street. Bullock Street will be extended north from Pike Street to KY 5<sup>th</sup> and KY 9<sup>th</sup> streets. Jillian's Way will be extended north from Pike Street to KY 9<sup>th</sup>, 5<sup>th</sup>, and 4<sup>th</sup> streets and allow for access to the existing Brent Spence Bridge.

Access to the interstate system from Covington will be provided by local city streets. In the northbound direction, access to I-75 will be provided at KY 9<sup>th</sup> Street, access to I-71 will be provided at KY 5<sup>th</sup> Street. Access to I-75 northbound will also be provided at KY 4<sup>th</sup> by the local C-D roadway across the lower deck of the existing Brent Spence Bridge and through downtown Cincinnati before connecting just south of the Linn Street Bridge. In the southbound direction, access to I-75/I-71 will be provided at KY 5<sup>th</sup> Street and KY 12<sup>th</sup> Street.

A new double deck bridge will be built just west of the existing Brent Spence Bridge to carry northbound and southbound I-71 and I-75 traffic. On the upper deck, I-71 southbound will have three lanes and I-71 northbound will have two lanes. On the lower deck, I-75 will have three northbound and three southbound lanes. The existing Brent Spence Bridge will be rehabilitated to carry northbound and southbound local traffic with two lanes in each direction.

In Ohio, Alternative E reconfigures I-75 through the I-71/I-75/US 50 Interchange and eliminates some of the existing access points along I-75. Existing ramps to I-71, US 50 and downtown Cincinnati will be reconfigured. The existing direct connections between I-75 to westbound and from eastbound US 50 will be maintained in Alternative E. US 50 will be reconfigured to eliminate left-hand entrances and exits. The OH 5<sup>th</sup> Street overpass will be eliminated and the Sixth Street Expressway will be reconfigured as a two-way, six-lane elevated roadway with a new signalized intersection for US 50 access and egress. Access between southbound I-71 (Fort Washington Way) and northbound I-75 will be provided near OH 9<sup>th</sup> Street as a direct connection. Both I-75 southbound and the local southbound C-D roadway will have access to northbound I-71 (Fort Washington Way).

A local C-D roadway will carry local traffic northbound from the existing Brent Spence Bridge and provide access to OH 2<sup>nd</sup>, 5<sup>th</sup>, and 9<sup>th</sup> streets, Winchell Avenue and access from OH 4<sup>th</sup> and 6<sup>th</sup> streets before reconnecting to I-75 just south of the Linn Street overpass. The northbound ramp from OH 9<sup>th</sup> Street to I-75 will be removed requiring traffic from this point to utilize a new local roadway parallel to I-75 and access the interstate at Bank Street. Southbound I-75 traffic will separate from the local C-D roadway near Ezzard Charles Drive. The southbound C-D roadway will carry traffic over I-75 to OH 7<sup>th</sup> Street, allowing traffic to either; access downtown at 7<sup>th</sup> Street, travel south to OH 5<sup>th</sup> and 2<sup>nd</sup> streets, or travel across the existing Brent Spence Bridge into Covington. Access to the local southbound C-D roadway will be provided at Western Avenue and at OH 4<sup>th</sup> and 8<sup>th</sup> streets.

Alternative E also improves Western and Winchell avenues to facilitate traffic flow and increase capacity. The ramps to Western Avenue and from Winchell Avenue just north of Ezzard Charles Drive will be removed. The northbound ramp from Freeman Avenue to I-75 will remain but the southbound ramp to Freeman will be eliminated. Between Ezzard Charles Drive and Western Hills Viaduct, southbound I-75 will have six lanes, northbound I-75 will have five lanes, and one auxiliary lane to the Western Hills Viaduct.

The Western Hills Viaduct Interchange will be reconfigured to provide a full movement interchange.

### **2.3.6 Alternative F**

Alternative F (Exhibit 9A – 9B) utilizes the existing I-71/I-75 alignment from the southern project limits at the Dixie Highway Interchange north to the Kyles Lane Interchange. The Dixie Highway and Kyles Lane interchanges will be modified slightly to accommodate a C-D roadway, which will be constructed along both sides of I-71/I-75 between the two interchanges. North of the Kyles Lane Interchange, the alignment shifts to the west to accommodate additional I-71/I-75 travel lanes. Between Kyles Lane and KY 12<sup>th</sup> Street, six lanes will be provided in each direction for a total of 12 travel lanes. Near KY 12<sup>th</sup> Street, the alignment separates into three routes for I-71, I-75 and a local C-D roadway.

In Alternative F, there are two access points into Covington for both northbound and southbound traffic. In the northbound direction, access will be provided by the local C-D roadway at KY 12<sup>th</sup> Street and KY 5<sup>th</sup> Street. In the southbound direction, access will be provided by the local C-D roadway at KY 5<sup>th</sup> Street and KY 9<sup>th</sup> Street. Access to the interstate system from Covington will be provided by local city streets. In the northbound direction, access to I-71 will be provided at KY 9<sup>th</sup> Street, and access to I-71/I-75 will be provided by the local C-D roadway at KY 9<sup>th</sup> and 4<sup>th</sup> streets. In the southbound direction, Crescent Avenue will be realigned and extended to the Bullock Street intersection and access to I-75/I-71 will be provided at KY 12<sup>th</sup> Street.

A new double deck bridge will be built just west of the existing Brent Spence Bridge to carry northbound and southbound I-75 (two lanes in each direction), two lanes for southbound I-71 and two lanes for southbound local traffic. The existing Brent Spence Bridge will be rehabilitated to carry two lanes for northbound I-71 and three lanes for local northbound traffic.

Alternative F reconfigures I-75 through the I-71/I-75/US 50 Interchange and eliminates all access to and from I-75 between KY 12<sup>th</sup> Street to just north of Ezzard Charles Drive in the northbound direction. Between KY 9<sup>th</sup> Street and Western Hills Viaduct there will be no access to southbound I-75. In Ohio, I-75 would be elevated from the Ohio River to just south of Linn Street. US 50 would also be realigned, which eliminates left-hand entrances and exits and provides a direct connection to the Clay Wade Bailey Bridge and the southbound local C-D roadway. OH 4<sup>th</sup> Street will be extended west to connect to a new north-south local street that connects US 50/C-D southbound traffic with the Clay Wade Bailey/OH 3<sup>rd</sup> Street intersection. A direct connection from I-75 southbound to westbound US 50 will be provided by the southbound local C-D roadway.

The northbound C-D roadway will carry local traffic from the existing Brent Spence Bridge, provide access to US 50 westbound and OH 2<sup>nd</sup> and 5<sup>th</sup> streets, and reconnect to I-75 just north of Ezzard Charles Drive. Alternative F connects to the northbound local C-D roadway from OH 3<sup>rd</sup>, 4<sup>th</sup>, and 6<sup>th</sup> streets. The northbound ramps from OH 9<sup>th</sup> Street and Freeman Avenue to I-75 will be removed, which requires traffic to utilize Winchell Avenue for access to northbound I-75. Existing connection to I-71, US 50, and downtown Cincinnati will be maintained. The southbound C-D roadway will carry traffic into downtown Cincinnati and Covington. Access will be maintained for OH 7<sup>th</sup> and 5<sup>th</sup> streets, I-71 NB (Fort Washington Way), and OH 2<sup>nd</sup> Street. A new direct connection from I-75 southbound to westbound US 50 and Clay Wade Bailey will be provided by the

southbound local C-D roadway. Access to the local southbound C-D roadway will be provided at Wester Avenue, OH 9<sup>th</sup> Street, US 50 eastbound, I-71 southbound (Fort Washington Way), and OH 3<sup>rd</sup> Street.

Between Ezzard Charles Drive and Western Hills Viaduct, I-75 northbound will provide five lanes. Southbound I-75 will have five lanes north of the Western Hills Viaduct with two lanes continuing on the south side of the viaduct. At the same point, four lanes will continue southbound for the local C-D roadway. Alternative F also improves Western and Winchell avenues to facilitate traffic flow and increase capacity. The ramps to Western Avenue just north of Ezzard Charles Drive will be removed. The existing ramp from Winchell Avenue/Ezzard Charles Drive will be maintained by braiding with the ramp to the Western Hills Viaduct. The Western Hills Viaduct Interchange will be reconfigured to provide a full movement interchange.

### **2.3.7 Alternative G**

Alternative G (Exhibit 10A – 10B; Appendix B, Exhibit B5-A and B5-B for Cross Section Layout Plan, B6-A through B6-QQ for Roadway Cross Sections, B7-A for Main Span Bridge Cross Section) utilizes the existing I-71/I-75 alignment from the southern project limits at the Dixie Highway Interchange north to the Kyles Lane Interchange. The Dixie Highway and Kyles Lane interchanges will be modified slightly to accommodate a C-D roadway, which will be constructed along both sides of I-71/I-75 between the two interchanges. North of the Kyles Lane Interchange, the alignment shifts to the west to accommodate additional I-71/I-75 travel lanes. Between Kyles Lane and KY 12<sup>th</sup> Street, six lanes will be provided in each direction for a total of 12 travel lanes. Near KY 12<sup>th</sup> Street, the alignment separates into three routes for I-71, I-75 and a local C-D roadway.

In Alternative G, there are two access points into Covington for both northbound and southbound traffic. In the northbound direction, access will be provided by the local C-D roadway at KY 12<sup>th</sup> Street and KY 5<sup>th</sup> Street. In the southbound direction, access will be provided by the local C-D roadway at KY 5<sup>th</sup> Street and KY 9<sup>th</sup> Street. Access to the interstate system from Covington will be provided by local city streets. In the northbound direction, access to I-71 will be provided at KY 9<sup>th</sup> Street, and access to I-71/I-75 will be provided by the local C-D roadway at KY 4<sup>th</sup> Street. In the southbound direction, Crescent Avenue will be realigned and extended to the Bullock Street intersection and access to I-75/I-71 will be provided at KY 12<sup>th</sup> Street.

A new double deck bridge will be built just west of the existing Brent Spence Bridge to carry northbound and southbound I-75 (two lanes in each direction), two lanes for southbound I-71 and two lanes for southbound local traffic. The existing Brent Spence Bridge will be rehabilitated to carry two lanes for northbound I-71 and three lanes for local northbound traffic.

Alternative G reconfigures I-75 through the I-71/I-75/US 50 Interchange and eliminates all access to and from I-75 between KY 12<sup>th</sup> Street to just north of Ezzard Charles Drive in the northbound direction. Between KY 9<sup>th</sup> Street and Western Hills Viaduct there will be no access to southbound I-75. In Ohio, I-75 will be elevated from the Ohio River to just south of Linn Street. US 50 will also be realigned, which eliminates left-hand entrances and exits. The northbound C-D roadway will carry local traffic from the existing Brent Spence Bridge, provide access to I-71 northbound (Fort Washington Way), US 50 westbound, OH 2<sup>nd</sup> and 5<sup>th</sup> streets, Winchell Avenue, and reconnect to I-75

just north of Ezzard Charles Drive. Alternative G provides a new connection from OH 3<sup>rd</sup> Street to the northbound local C-D roadway with realigned connections from OH 4<sup>th</sup> and 6<sup>th</sup> streets. The northbound ramps from OH 9<sup>th</sup> Street and Freeman Avenue to I-75 will be removed, which requires traffic to utilize Winchell Avenue for access to northbound I-75. The southbound C-D roadway will carry traffic into downtown Cincinnati and Covington. Access will be maintained for OH 7<sup>th</sup> and 5<sup>th</sup> streets, I-71 northbound (Fort Washington Way), and OH 2<sup>nd</sup> Street. Alternative G provides a direct connection to the Clay Wade Bailey Bridge from the southbound local C-D roadway and from US 50 eastbound. Access to the local southbound C-D roadway will be provided at Western Avenue, OH 9<sup>th</sup> Street, US 50 eastbound, I-71 southbound, and OH 3<sup>rd</sup> Street.

Between Ezzard Charles Drive and Western Hills Viaduct, I-75 northbound will be five lanes. Southbound I-75 will be five lanes north of the Western Hills Viaduct with two lanes continuing on the south side of the viaduct. At the same point, four lanes will continue southbound for the local C-D roadway. Alternative G also improves Western and Winchell avenues to facilitate traffic flow and increase capacity. The ramps to Western Avenue just north of Ezzard Charles Drive will be removed. The existing ramp from Winchell Avenue/Ezzard Charles Drive will be maintained by braiding with the ramp to the Western Hills Viaduct. The northbound ramps from OH 9<sup>th</sup> Street and Freeman Avenue to I-75 will be removed, which requires traffic to utilize Winchell Avenue for access to northbound I-75 just north of Ezzard Charles Drive. The Western Hills Viaduct Interchange will be reconfigured to provide a full movement interchange.

### **2.3.8 Alternative H**

Alternative H is the same as Alternative 5 from the *Planning Study Report* (Appendix F). This alternative was not developed in more detail because it was eliminated from further consideration at the beginning of Step 5. Early in the design process, it was determined that this alternative had alignment configurations issues that would not make it feasible to carry forward. The following is a brief overview of Alternative H.

Alternative H utilized the existing I-71/I-75 alignment from the Kyles Lane Interchange to the City of Covington. Between Kyles Lane and KY 5<sup>th</sup> Street, seven lanes were proposed in each direction for a total of 14 travel lanes. North of the Kyles Lane Interchange, the alignment shifted to the west to accommodate these additional travel lanes. I-75 traffic was separated from I-71 and local traffic just south of KY 12<sup>th</sup> street in Covington to Ezzard Charles Drive in Cincinnati. Two new single-deck bridges were proposed on either side of the existing Brent Spence Bridge for I-75 traffic only. I-71 and local traffic were to utilize the existing bridge, which would have been improved.

No direct access to and from I-75 was proposed between just south of KY 12<sup>th</sup> street in Kentucky and Ezzard Charles Drive in Ohio. In order to access northbound I-75, local traffic would have to cross the existing Brent Spence Bridge on the lower deck, travel through the I-71/I-75/US 50 Interchange, and merge onto I-75 in the vicinity of Ezzard Charles Drive in Cincinnati.

In Ohio, I-75 followed the existing I-75 alignment and was widened to five lanes in each direction through the I-71/I-75/US 50 Interchange. All ramps and existing connections to US 50 and local city streets remained. Between Ezzard Charles Drive and the Western Hills Viaduct, five lanes were proposed in the northbound and southbound directions for

a total of 10 travel lanes. The existing ramps and crossroads would have remained with minimal reconstruction.

### **2.3.9 Conceptual Alternatives Summary**

All of the conceptual alternatives are the same at the south and north ends of the project corridor. In Kentucky, South of KY 12<sup>th</sup> Street, I-71/I-75 has six lanes northbound and southbound. North of Western Hills Viaduct in Ohio, I-75 has five lanes northbound and southbound. The configurations of the Dixie Highway, Kyles Lane, and Western Hills Viaduct interchanges are the same for all conceptual alternatives. Each alternative also improves Western and Winchell avenues in Ohio to facilitate traffic flow and increase capacity.

The differences among the conceptual alternatives are in the design configuration, access points, and number of lanes that occur between 12<sup>th</sup> Street in Kentucky to Ezzard Charles Drive in Ohio. Table 3 provides a summary of the design elements of each conceptual alternative.

*This page intentionally left blank.*

Table 3. Summary of Design Elements

		Between KY 12 <sup>th</sup> Street to Ohio River																
		I-71/I-75				I-71				I-75		C-D Roadway						
		To	From			To	From			To	From	To			From			
		C-D Roadway	C-D Roadway	KY 5 <sup>th</sup> Street	KY 12 <sup>th</sup> Street	KY 9 <sup>th</sup> Street	Pike Street	KY 9 <sup>th</sup> Street	KY 5 <sup>th</sup> Street	KY 9 <sup>th</sup> Street	KY 9 <sup>th</sup> Street	I-71/I-75	KY 12 <sup>th</sup> Street	KY 9 <sup>th</sup> Street	KY 5 <sup>th</sup> Street	Pike Street	KY 9 <sup>th</sup> Street	KY 4 <sup>th</sup> Street
Access Points	Northbound	Alternative B	•				•	•					•		•			
		Alternative C	•				•					•			•			
		Alternative D	•						•				•			•		
		Alternative E	•						•		•			•			•	
		Alternative G	•						•			•		•		•	•	
	Southbound	Alternative B		•		•						•		•				
		Alternative C		•		•						•		•				
		Alternative D		•		•						•		•				
		Alternative E		•	•	•	•			•				•				
		Alternative G		•		•						•		•				

Table 3. Summary of Design Elements

		Between Ohio River and Ezzard Charles																																	
		I-71			I-75						C-D Roadway																								
		To		From	To			From			To										From														
		FWW EB	C-D Roadway	OH 3 <sup>rd</sup> Street	US 50 WB	OH 6 <sup>th</sup> Street	FWW EB	Freeman Avenue	US 50 EB	FWW WB	OH 2 <sup>nd</sup> Street	FWW EB	US 50 WB	US 50 EB	OH 5 <sup>th</sup> Street	OH 6 <sup>th</sup> Street	OH 7 <sup>th</sup> Street	OH 9 <sup>th</sup> Street	Freeman Avenue	Winchell Avenue	I-75	OH 3 <sup>rd</sup> Street	FWW WB	OH 4 <sup>th</sup> Street	US 50 EB	OH 6 <sup>th</sup> Street	OH 7 <sup>th</sup> Street	OH 8 <sup>th</sup> Street	OH 9 <sup>th</sup> Street	Freeman Avenue	Western Avenue	I-75			
Access Points	Northbound	Alternative B	•							•		•									•		•	•											
		Alternative C	•								•				•							•		•	•										
		Alternative D	•								•				•							•		•	•										
		Alternative E	•			•	•		•		•				•			•		•		•		•	•										
		Alternative G	•	•							•	•			•					•		•		•	•										
	Southbound	Alternative B									•	•			•		•		•				•	•		•					•		•	•	
		Alternative C									•	•			•		•		•				•	•		•					•		•	•	
		Alternative D									•	•			•		•		•				•	•		•					•		•	•	
		Alternative E									•	•			•		•		•				•	•		•				•		•	•	•	
		Alternative G		•							•	•		•		•	•		•				•	•		•				•		•	•	•	



Table 3. Summary of Design Elements

		Between KY 12 <sup>th</sup> and KY 9 <sup>th</sup> Street								Between KY 9 <sup>th</sup> to Ohio River						Between Ohio River to US 50						US 50 to Ezzard Charles			
		I-71/I-75		I-75		I-71		C-D Roadway		I-75		I-71		C-D Roadway		I-75		US 50		C-D Roadway		I-75		C-D Roadway	
		NB	SB	NB	SB	NB	SB	NB	SB	NB	SB	NB	SB	NB	SB	NB	SB	EB	WB	NB	SB	NB	SB	NB	SB
Number of Lanes	Alternative B	-	5	2	-	2	-	2	-	2	2	2	2	3	2	2	2	2	2	3	1	2	2	3	4
	Alternative C	-	5	2	-	2	-	2	-	2	2	2	2	3	2	2	2	2	2	4	1	2	2	4	4
	Alternative D	-	5	2	-	2	-	2	-	2	2	2	2	3	2	2	2	2	2	3	3	2	2	3	5
	Alternative E	-	5	3	-	2	2	2	-	3	3	2	3	2	2	3	3	1	1	2	3	6	4	-	3
	Alternative G	-	5	2	-	2	2	2	-	2	2	2	2	2	2	2	2	2	2	4	4	2	2	4	4

*This page intentionally left blank.*

## **2.4 Alternatives Eliminated from Further Consideration**

Three of the mainline alternatives, Alternatives A, F, and H, were eliminated in the early stages of Step 5 of the PDP. Alternatives A and H were eliminated from further consideration due to fatal flaws, which were identified as the alternatives were developed in more detail. Alternative F was eliminated from further consideration because it was very similar to Alternative G and did not provide any additional benefit. Reasons for eliminating Alternatives A, F, and H from further study are described in the following sections.

### **2.4.1 Elimination of Alternative A**

Alternative A was originally developed as part of the *Feasibility and Constructability Study* as an avoidance alignment for Longworth Hall. Longworth Hall is listed on the National Register of Historic Places (NRHP) and is also a Section 4(f) resource. Alternative A was carried forward into the current Brent Spence Bridge Replacement/Rehabilitation Project again as an avoidance alternative for Longworth Hall.

Alternative A was Alternative 1 from Step 4 of the PDP, which included a new Queensgate Bridge for I-75 and rehabilitation of existing Brent Spence Bridge for I-71 and local traffic. The operational characteristics of Alternative A were based on traffic data available during Step 4 of the project. In addition to avoiding Longworth Hall, Alternative A provided other benefits which included: the option of separating local and regional traffic, to the extent possible, from the downtown areas of the cities of Covington and Cincinnati; minimizing impacts to the downtown infrastructure and right of way; and providing a viable alternative to the remaining alternatives on existing alignments.

At the beginning of Step 5, a Travel Lane Evaluation Study (TLES) was performed in April 2007. The findings of the TLES determined that the original concept for Alternative A would have to be modified to accommodate the high volume of I-71 and local traffic utilizing the existing Brent Spence Bridge.

The Step 5 design for Alternative A proposed that near KY 12<sup>th</sup> Street, Alternative A would separate into two alignments, one for I-75 and the other for I-71 and a local C-D roadway network. The I-75 alignment would run along the western limits of the City of Covington between Western Avenue and Crescent Avenue. The I-71 alignment and the local C-D roadway alignment would run along the existing I-71/I-75 alignment.

A new single-deck bridge or two twin single-deck bridges would be constructed approximately 900 feet west of the existing Brent Spence Bridge for I-75 traffic only. The new I-75 alignment would pass through the Queensgate area and reconnect to the existing corridor just south of Ezzard Charles Drive in Ohio. At this point, Alternative A would follow the existing I-75 corridor to the Western Hills Viaduct. Four travel lanes, two lanes in each direction would be provided for northbound and southbound I-75 traffic.

A new double deck bridge would be built just west of the existing Brent Spence Bridge to carry southbound I-71 and southbound local traffic. The existing Brent Spence Bridge would be rehabilitated to carry northbound I-71 and northbound local traffic. The required approaches to connect to the new bridge carrying southbound I-71 and local

traffic would directly impact 160 feet of the eastern end of Longworth Hall. As a result, Alternative A was no longer an avoidance alternative for Longworth Hall.

Due to the findings of the TLES, modifications to the original concept for Alternative A, and direct impact to Longworth Hall, Alternative A could no longer be considered an avoidance alternative with respect to the anticipated direct impacts to Longworth Hall. Therefore, Alternative A was eliminated from further consideration in the early stages of Step 5.

#### **2.4.2 Elimination of Alternative F**

Alternative F and Alternative G designs were based on the same concept of providing an expanded local street configuration with a new access connection to the north end of the Clay Wade Bailey Bridge with one difference in Ohio. Alternative F provides a direct connection from I-75 southbound to westbound US 50 via the southbound local C-D roadway. Alternative G does not provide this direct connection between I-75 southbound and westbound US 50. All other major design features are the same between these two alternatives.

Under current conditions, a direct connection does not exist between I-75 southbound and US 50 westbound. In order to access US 50 westbound from I-75 southbound, vehicles must exit the interstate at Freeman Avenue and travel on Freeman Avenue to access US 50 westbound. As part of this study, the project team developed Alternative F to explore the option of having a direct connection from I-75 southbound to westbound US 50 via a southbound local C-D roadway. The design speed for this connection would be 25 miles per hour.

An Origin and Destination (O-D) Study was conducted in 2006 to establish travel patterns of cars and trucks between I-75 and US 50. Traffic data were collected on weekdays (Wednesday and Thursday) during the morning (6:00 to 10:00 AM), mid-day (11:00 AM to 2:00 PM), and evening (4:00 to 7:00 PM) peak periods. The O-D Study revealed that the morning and mid-day peak period traffic volumes for vehicles traveling from the "southbound I-75 off ramp to Freeman Avenue" to the "westbound US 50 on ramp from Freeman Avenue" were each approximately 400 vehicles. The traffic volumes in the evening peak period between these connections were approximately 700 vehicles.

The O-D Study determined that a limited number of vehicles travel between southbound I-75 and westbound US 50. ODOT determined that the documented traffic volumes did not support the need for a direct connection between southbound I-75 and westbound US 50. Based on the results of the O-D Study, Alternative F was eliminated from further consideration. The results of the O-D Study are documented in *I-71/US-50 Origin-Destination Study (January 2007)*, which is located in Appendix F on CD.

#### **2.4.3 Elimination of Alternative H**

Alternative H is the same as Alternative 5 from Step 4 of the PDP. Alternative H proposed to construct two new single-deck bridges for I-75 on either side of the existing Brent Spence Bridge. The new bridge on the east side of the existing Brent Spence Bridge would carry northbound I-75 traffic and the new bridge on the west side of the existing bridge would carry southbound I-75 traffic. The existing Brent Spence Bridge

would be rehabilitated to carry I-71 and local traffic. Northbound traffic would travel on the lower deck and southbound traffic would travel on the upper deck.

The existing approaches to the Brent Spence Bridge on the north side of the Ohio River consist of complex geometry with maximum grades and minimum horizontal curvature. During development of the preliminary horizontal and vertical alignments for Alternative H in the early stages of Step 5, the Design Team was unable to provide sufficient geometrics for the additional approaches on the north side of the Ohio River. Specifically, the northbound I-75 approach for the new bridge on the east side of the existing Brent Spence Bridge would have to cross over the existing northbound ramp from the Brent Spence Bridge to northbound I-71 (Fort Washington Way) and over the existing southbound I-71 (Fort Washington Way) ramp to the existing Brent Spence Bridge. Then the proposed northbound I-75 alignment would have to cross under the proposed US 50 eastbound to the OH 5<sup>th</sup> Street Bridge. In order to maintain the required vertical clearance, the proposed northbound I-75 vertical alignment required a seven percent vertical down grade. ODOT's maximum vertical grade for interstate highways is five percent where development in urban areas precludes the use of flatter grades. Grades exceeding five percent can lead to increased driving speeds and the need for increased stopping distances, which can produce operational and safety problems.

Additionally, the April 2007 TLES determined that the original concept for Alternative H would have to be modified to accommodate the high volume of I-71 and local traffic utilizing the existing Brent Spence Bridge. The two proposed single-deck bridges on both side of the existing Brent Spence Bridge would have to be double-deck bridges to accommodate estimated traffic volumes. Additional design work was conducted to determine if the inability to provide acceptable vertical and horizontal alignments could be corrected by reconfiguring the flow of traffic across the three bridges. It was determined that the double-deck bridges could not provide an appropriate vertical alignment for the northbound I-75 approach. As a result, Alternative H was eliminated from further consideration in the early stages of Step 5 due to geometric design problems.

## **2.5 Western Hill Viaduct Interchange Sub-Alternatives**

The Western Hills Viaduct Interchange is located at the northern end of the Brent Spence Bridge project study limits and is adjacent to the Mill Creek Expressway project. In Step 4 of the PDP sub-alternatives were developed for the Western Hills Viaduct Interchange and presented in the *Planning Study Report (September 2006)*. The Western Hills Viaduct Interchange sub-alternatives were:

- a roundabout at the eastern edge of the bridge;
- a roundabout centered over I-75; and
- a Single Point Urban Interchange (SPUI).

These three sub-alternatives were studied in more detail in Step 5 of the PDP. Based on anticipated traffic volumes for the design year (2035), it was determined that both roundabout alternatives would be over capacity and would therefore not function properly. It was determined that the SPUI would also be over capacity in 2035 and would not function correctly with the double-deck bridge to the west. For these reasons,

all three sub-alternatives for the Western Hills Viaduct Interchange were eliminated from further consideration.

At the southern limits of the Mill Creek Expressway project is the Hopple Street Interchange which is located less than one mile from the Western Hills Viaduct Interchange. The Hopple Street Interchange is being redesigned as part of the Mill Creek Expressway project and is currently in Stage 1 design. It is funded for construction and will be operational prior to the Mill Creek Expressway Interchange.

During Step 5 of the PDP, the Design Team developed a new configuration for the Western Hills Viaduct Interchange, which is presented in the five mainline conceptual alternatives (Exhibits 4 through 10). The new configuration provides for a full movement interchange and operates at an acceptable level of service in 2035. However, the interchange does not work geometrically with the proposed Hopple Street Interchange that is currently being designed. There is a conflict with the northbound entering traffic from the Western Hills Viaduct Interchange and the exiting northbound traffic to Hopple Street. There is not enough weave distance between interchanges to bring Western Hills Viaduct traffic onto the freeway northbound before having traffic exit to Hopple Street. Additional solutions for Western Hills Viaduct Interchange will be developed and extensively investigated in Step 6 of the PDP.

## **2.6 Alternative Design Criteria**

### **2.6.1 Design Criteria**

The conceptual alternatives were developed in accordance with the geometric design criteria requirements of both KYTC and ODOT (Table 4). The Kentucky section of the conceptual alternatives was designed in accordance with the most current version of KYTC's *Highway Design Manual* and the Ohio section of the conceptual alternatives was designed in accordance with the most current version of ODOT's *Location and Design Manual*.

In Kentucky, three categories of design requirements were applied to the conceptual alternatives; mainline, service ramps, and local streets. In Ohio, four categories of design requirements were applied to the conceptual alternatives; mainline, directional ramps, service ramps, and local streets. Each of these categories has a roadway classification and design speed. The functional classification of the mainline roadway is "Principal Arterial – Interstate (Urban)" with a design speed of 60 miles per hour (mph). The directional ramps and service ramps are classified as "Collector (Urban)" with design speeds varying from 30 to 60 mph; and the local streets are classified as "Local (Urban)" with a design speed of 30 mph in Kentucky and 40 mph in Ohio. The required criteria for the nine categories of design features, with detailed subcategories, and the location of reference information in the respective design manuals, are detailed in Table 4. Engineering line diagrams, and geometric plans and profiles of each conceptual alternative are provided in Appendix C. Typical sections at critical locations for each of the alternatives are provided in Appendix B.

Graded shoulder widths and type of grading within the project limits will be studied in the next step of the project as the designs progress in more detail. The typical sections in Appendix B indicate estimated shoulder widths taking into considerations both KYTC's and ODOT's standards, maintenance of traffic needs during construction and future

rehabilitation projects, and existing conditions. Due to the urban environment of the project, it is anticipated that a combination of retaining walls, sound walls, roadside barriers, median barriers, and curbs will be used. These elements will be coordinated with proposed shoulder widths, type, taper rates, cross slope, and lateral clearance needs.

Signing plans were developed for each of the conceptual alternatives and are provided in Appendix C. These plans were developed in compliance with FHWA's *Manual of Uniform Traffic Control Devices (MUTCD) (revised December 2007)*, the *Ohio Manual of Uniform Traffic Control Devices (OMUTCD) (December 2005)*, as well as other signage standards in Kentucky and Ohio. Guide signs are essential to direct motorists along the interstate, as well as other roads and streets. They inform motorists of intersecting routes, direct them to cities, towns, or other important destinations, and generally provide information that assist motorists in reaching their destinations in the most simple and direct manner possible.

A central part of the project is the rehabilitation/replacement of the existing Brent Spence Bridge. New structures would include an open span to preserve the navigation channel of the Ohio River. Coordination with the US Coast Guard (USCG) was initiated to determine locations of bridge piers in the Ohio River. Typical sections of the proposed bridges are provided in Appendix B.

Alternative B would cross the Ohio River on a new bridge approximately 1,000 feet west of the existing Brent Spence Bridge. In Kentucky, the southern mainspan pier would be located on the bank of the Ohio River between the existing floodwall wall and the waters edge. In Ohio, the northern mainspan pier would be located on the bank of the Ohio River approximately 1,650 feet north of the southern pier. It is anticipated that less than 10 percent of either pier would be located within the Ohio River due to the skew angle of the bridge, the bend in the Ohio River at this location and the size of the piers. The bridge abutments would be located 650 feet north and south of the proposed mainspan piers.

Alternatives C, D, E, and G would cross the Ohio River on a new bridge located approximately 120 feet west of the existing Brent Spence Bridge. In accordance with USCG requirements, the piers for this bridge must be placed "outside" of the existing Brent Spence Bridge piers. The piers would be placed in the Ohio River approximately 35 feet closer to the banks of the Ohio River than the current Brent Spence Bridge piers. The existing Brent Spence Bridge has a middle span length of 830.5 feet between existing piers. The new bridge would have a middle span length of approximately 900 feet from center to center of the proposed piers. The bridge abutments would be located approximately 400 feet north and south of the proposed piers.

*This page intentionally left blank.*



Table 4. Geometric Design Criteria

Design Feature	Design Criteria - Ohio								Design Criteria - Kentucky						Notes
	Mainline (60 mph)		Directional Ramp <sup>1</sup> (60/45 mph)		Service Ramp <sup>2</sup> (50/40/30 mph)		Local Street (40 mph)		Mainline (60 mph)		Service Ramp <sup>2</sup> (50/40/30 mph)		Local Street (30 mph)		
<b>Horizontal Alignment</b>															
Maximum Centerline Deflection without Horizontal Curve	1°00'	Fig 202-1E	1°00' 1°45'	Fig 202-1E	1°15' 2°15' 3°45'	Fig 202-1E	2°15'	Fig 202-1E	n/a		n/a		n/a		
Maximum Degree of Curve	4°15'	Fig 202-2E	4°15' 9°00'	Fig 202-2E Fig 202-10E	6°45' 11°45' 24°45'	Fig 202-2E Fig 202-10E Fig 202-10E	10°45'	Fig 202-9E	1205'	Exhibit 3-23 pg. 161	835' 510' 275'	Exhibit 3-22 pg. 159	300'	Exhibit 3-21 pg. 157	
Maximum Curve without Super	0°33'	Fig 202-3E	0°33' 0°57'	Fig 202-3E Fig 202-10E	0°47' 1°10' 1°58'	Fig 202-3E Fig 202-10E Fig 202-10E	7°42'	Fig 202-9E	12000'	Exhibit 3-23 pg. 161	8000' 6000' 3500'	Exhibit 3-22 pg. 159	3500'	Exhibit 3-21 pg. 157	
Maximum Superelevation (e <sub>max</sub> )	6.00%	Fig 202-8E	6.00%	Fig 202-8E Fig 202-10E	6.00%	Fig 202-8E Fig 202-10E	4.00%	Fig 202-9E	8.00%		6.00%		4.00%		
<b>Vertical Alignment</b>															
Maximum Grade <sup>3</sup>	4.00 %	Fig 203-1E	6.00 %	Fig 203-1E	6.00 %	Fig 203-1E	10.00 %	Fig 203-1E	4.00 %	Exhibit 8-1 pg. 510	5.00 %	pg. 833	11.00 %	1% steeper may be used in extreme cases or for one-way downgrades.	
Maximum Vertical Deflection without a Vertical Curve	0.30%	Fig 203-2E	0.30% 0.55%	Fig 203-2E	0.45% 0.75% 1.30%	Fig 203-2E	0.75%	Fig 203-2E	n/a		n/a		n/a	Minimum distance between deflections is 100' for speed ≥ 50 mph, 50' for speed < 50 mph.	
Pavement Cross Slopes (normal)	0.016	301.1.5	---	---	---	---	---	---	2.00%		---	---	---	---	
Use of Spirals	D > 3°	202-11 202-5	---	---	---	---	---	---	e > 3.0%		---	---	---	---	
Spiral Length	≥ Length of Runoff		---	---	---	---	---	---	Length of Runoff		---	---	---	---	
Transition Length / Rate (drop line)	L = 60 x Lane Width	301.1.4	---	---	---	---	---	---	L = 50:1 to 70:1		---	---	---	---	
Pavement Slope Transition	222:1 max	Fig 202-4E	222:1 max 185:1 max	Fig 202-4E	200:1 max 172:1 max 152:1 max	Fig 202-4E	172:1	Fig 202-4E	222:1 max	Exhibit 3-27 pg. 170	200:1 max 172:1 max 152:1 max	Exhibit 3-27 pg. 170	152:1	Exhibit 3-27 pg. 170	For methods of transition see Figures 202-5, 202-5a, 202-5b, 202-5c, 202-5d, 202-6.

Table 4. Geometric Design Criteria

Design Feature	Design Criteria - Ohio								Design Criteria - Kentucky						Notes
	Mainline (60 mph)		Directional Ramp <sup>1</sup> (60/45 mph)		Service Ramp <sup>2</sup> (50/40/30 mph)		Local Street (40 mph)		Mainline (60 mph)		Service Ramp <sup>2</sup> (50/40/30 mph)		Local Street (30 mph)		
Grade Point Position	Inside Edge		Inside/Outside Edge		Inside/Outside Edge		Outside Edge		Inside Edge		Inside/Outside Edge		Outside Edge		
<b>K-Values</b>															
Crest Vertical Curve	151	Fig 203-3E	151 61	Fig 203-3E	84 44 19	Fig 203-3E	44	Fig 203-3E	151	Exhibit 3-76 pg. 274	84 44 19	Exhibit 3-76 pg. 274	19	Exhibit 3-76 pg. 274	
Sag Vertical Curve <sup>4</sup>	136	Fig 203-6E	136 79	Fig 203-6E	96 64 37	Fig 203-6E	64	Fig 203-6E	136	Exhibit 3-79 pg. 280	96 64 37	Exhibit 3-79 pg. 280	37	Exhibit 3-79 pg. 280	
<b>Sight Distance</b>															
Stopping Sight Distance (vertical curves)	570' minimum	Fig 201-1E	570' 360'	Fig 201-1E	425' 305' 200'	Fig 201-1E	305'	Fig 201-1E	570' minimum	Exhibit 3-1 pg. 112	425' 305' 200'	Exhibit 3-1 pg. 112	200'	Exhibit 3-1 pg. 112	
Minimum Passing Sight Distance	---	---	---	---	---	---	1470'	Fig 201-3E	---	---	---	---	1090'	Exhibit 3-7 pg. 124	
Intersection Sight Distance	---	---	---	---	---	---	445' Left 385' Right	Fig 201-5E	---	---	---	---	335' Left 290' Right	Exhibit 9-55 pg. 665 Exhibit 9-58 pg. 668	See Fig. 201-4 also.
Decision Sight Distance	1150' (B) 1280' (E)	Fig 201-6E	1150' (B) 1280' (E) 800' (B) 930' (E)	Fig 201-6E	910' (B) 1030' (E) 690' (B) 825' (E) 490' (B) 620' (E)	Fig 201-6E	690' (B) 825' (E)	Fig 201-6E	1150' (B) 1280' (E)	Exhibit 3-3 pg. 116	910' (B) 1030' (E) 690' (B) 825' (E) 490' (B) 620' (E)	Exhibit 3-3 pg. 116	490' (B) 620' (E)	Exhibit 3-3 pg. 116	
<b>Clearances (New and Reconstructed)</b>															
Lateral On Bridge (≥ 200' long)	12' Right 12' Median ≤ 2 lanes 12' Right, 4' Left	Fig 302-1E	<u>1-Lane / 2-Lane</u> 8' Right / 12' Right 6' Left / 6' Left	Fig 303-1E	8' Right 6' Left	Fig 303-1E	<u>Uncurbed / Curbed</u> 4'-10' / 1'-2'	Fig 301-4E	12' Right 12' Median	pg. 765	8' Right 6' Left	pg. 765	<u>Uncurbed / Curbed</u> 4'-10' / 1'-2'	12' accommodates future maintenance of traffic 4' lateral on median allowed on four-lane alternative.	
Lateral On Bridge (≤ 200' long)	12' Right 12' Median ≤ 2 lanes 12' Right, 4' Left	Fig 302-1E	<u>1-Lane / 2-Lane</u> 8' Right / 12' Right 6' Left / 6' Left	Fig 303-1E	8' Right 6' Left	Fig 303-1E	<u>Uncurbed / Curbed</u> 4'-10' / 1'-2'	Fig 301-4E	12' Right 12' Median	pg. 765	8' Right 6' Left	pg. 765	<u>Uncurbed / Curbed</u> 4'-10' / 1'-2'	12' accommodates future m. 4' lateral on median allowed on four-lane alternative.	

Table 4. Geometric Design Criteria

Design Feature	Design Criteria - Ohio								Design Criteria - Kentucky						Notes
	Mainline (60 mph)		Directional Ramp <sup>1</sup> (60/45 mph)		Service Ramp <sup>2</sup> (50/40/30 mph)		Local Street (40 mph)		Mainline (60 mph)		Service Ramp <sup>2</sup> (50/40/30 mph)		Local Street (30 mph)		
Vertical	17.0' Preferred 15.5' Minimum	Fig 302-1E	17.0' Preferred 15.5' Minimum	Fig 302-1E	17.0' Preferred 15.5' Minimum	Fig 302-1E	15.0' Preferred 14.5' Minimum	Fig 302-1E	17.5' Preferred 15.5' Minimum	pg. 511	17.5' Preferred 15.5' Minimum	pg. 511	17' Preferred 14.5' Minimum	pg. 511	
Overhead Guide Signs (Double Decker)	17' Typical 15' Minimum	TEM Figure 298-11	17' Typical 15' Minimum	TEM Figure 298-11	17' Typical 15' Minimum	TEM Figure 298-11	NA	NA							
<b>Clear Zone</b>	(>6000 Average Daily Traffic [ADT])		(>6000 ADT)		(>6000 ADT)		(>6000 ADT)		(>6000 ADT)		(>6000 ADT)		(>6000 ADT)		
Foreslope 6:1 or Flatter	30'	Fig 600-1E	30' 19'	Fig 600-1E	19' 15' 15'	Fig 600-1E	15'	Fig 600-1E	30'	Table 3.1 3-6 <sup>a</sup>	22' 15' 15'	Table 3.1 3-6 <sup>a</sup>	15'	Table 3.1 3-6 <sup>a</sup>	
Foreslope Steeper than 6:1 to 4:1	30'	Fig 600-1E	30' 26'	Fig 600-1E	26' 17' 17'	Fig 600-1E	17'	Fig 600-1E	40'	Table 3.1 3-6 <sup>a</sup>	26' 17' 17'	Table 3.1 3-6 <sup>a</sup>	17'	Table 3.1 3-6 <sup>a</sup>	
Backslope 6:1 or Flatter	27'	Fig 600-1E	27' 21'	Fig 600-1E	21' 15' 15'	Fig 600-1E	15'	Fig 600-1E	27'	Table 3.1 3-6 <sup>a</sup>	22' 15' 15'	Table 3.1 3-6 <sup>a</sup>	15'	Table 3.1 3-6 <sup>a</sup>	
Backslope Steeper than 6:1 to 4:1	25'	Fig 600-1E	25' 19'	Fig 600-1E	19' 15' 15'	Fig 600-1E	15'	Fig 600-1E	25'	Table 3.1 3-6 <sup>a</sup>	20' 15' 15'	Table 3.1 3-6 <sup>a</sup>	15'	Table 3.1 3-6 <sup>a</sup>	
Backslope Steeper than 4:1	21'	Fig 600-1E	21' 15'	Fig 600-1E	15' 15' 15'	Fig 600-1E	15'	Fig 600-1E	21'	Table 3.1 3-6 <sup>a</sup>	15' 15' 15'	Table 3.1 3-6 <sup>a</sup>	15'	Table 3.1 3-6 <sup>a</sup>	
<b>Lanes</b>															
Number of Through Lanes	>3 (by alt)		2 or 1		2 or 1		Varies		>3 (by alt)		2 or 1		Varies		
Lane Width	12'	Fig 301-4E	12' (2-lane) 16' (1-lane)	Fig 303-1E	12' (2-lane) 16' (1-lane)	Fig 303-1E	12' 11' (Minimum)	Fig 301-4E	12'		12' (2-lane) 15' (1-lane)		12'		
<b>Shoulders</b>															
Treated Width	12' Right 12' Median ≤ 2 lanes 12' Right 4' Median	Fig 301-3E	10' Right / 4' Left 6' Right / 4' Left	Fig 303-1E <sup>5</sup>	6' Right / 3' Left	Fig 303-1E	2' Curb & Gutter	Fig 301-4E	10' Right 12' Median		6' Right / 4' Left		2' Curb & Gutter		12' accommodates future maintenance of traffic. 4' median shoulder allowed on four-lane alternative.
Graded Width with Barrier or Foreslopes Steeper Than 6:1	17' Right 17' Median	Fig 301-3E	15' Right / 9' Left 11' Right / 9' Left	Fig303-1E	15' Right / 9' Left 11' Right / 9' Left	Fig 303-1E	---	---	See Clear Zone Criteria		See Clear Zone Criteria		---	---	Two lane (top) One lane (bottom)

Table 4. Geometric Design Criteria

Design Feature	Design Criteria - Ohio								Design Criteria - Kentucky						Notes	
	Mainline (60 mph)		Directional Ramp <sup>1</sup> (60/45 mph)		Service Ramp <sup>2</sup> (50/40/30 mph)		Local Street (40 mph)		Mainline (60 mph)		Service Ramp <sup>2</sup> (50/40/30 mph)		Local Street (30 mph)			
Graded Width without Barrier and Foreslopes 6:1 or Flatter	12' Right 12' Median	Fig 301-3E	10' Right / 6' Left 8' Right / 6' Left	Fig 303-1E	10' Right / 6' Left 8' Right / 6' Left	Fig 303-1E	---	---	See Clear Zone Criteria		See Clear Zone Criteria		---	---	Two lane (top) One lane (bottom)	
Normal Barrier Offset	14' Right 14' Median 12' Right & Median if Concrete Barrier	Fig 301-3E Or 10' Right 4' Left for ≤ 2 lanes w/ Concrete Barrier	12' Right / 6' Left 8' Right / 6' Left	Fig 303-1E	12' Right / 6' Left 8' Right / 6' Left	Fig 303-1E	4' Minimum	602.1.5.1	14' Right 14' Median	pg. 319	8' Right / 6' Left		4' minimum		Two lane (top) One lane (bottom)	
Assumed Median Width	3"	---	---	---	---	---	---	---	3'	---	---	---	---	---		
Shoulder Pavement Cross Slopes (normal)	4.00%	Fig 301-8	4.00%	Fig 301-8	4.00%	Fig 301-8	4.00%	Fig 301-8	4.00%	pg. 320	4.00%	pg. 320	4.00%	pg. 320		
<b>Terminal Classification</b>																
Freeway Terminal	---	---	High Speed	Fig 503-2aE Fig 503-3aE	High Speed	Fig 503-2aE Fig 503-3aE	---	---	---	---	---	---	---	---		
	---	---	Low Speed	Fig 503-4aE Fig 503-4bE	Low Speed	Fig 503-4aE Fig 503-4bE	---	---	---	---	---	---	---	---		
	---	---	CD	Fig 504-1E Fig 504-2E	CD	Fig 504-1E Fig 504-2E	---	---	---	---	---	---	---	---		
	---	---	Multi-Entrance	Fig 505-1aE Fig 504-2E	Multi-Entrance	Fig 505-1aE Fig 504-2E	---	---	---	---	---	---	---	---	---	
	---	---	Multi-Exit	Fig 505-2aE Fig 505-2bE	Multi-Exit	Fig 505-2aE Fig 505-2bE	---	---	---	---	---	---	---	---	---	

Ohio geometric design criteria provided in the current ODOT *Location and Design Manual, Volume 1 and Traffic Engineering Manual*.

Kentucky geometric design criteria provided in the current KYTC *Highway Design Manual* and the American Association of State Highway and Transportation Officials (AASHTO) *Roadside Design Guide<sup>3</sup>* and the AASHTO "Green Book" (*A Policy on Geometric Design of Highways and Streets, Fourth Edition*).

Table notes:

- For Directional Ramps, top line indicates upper range speed (60 mph), second line indicates middle range speed (45 mph).
- For Service Ramps, top line indicates upper range speed (50 mph), middle line indicates middle range speed (40 mph), and bottom line indicates lower range speed (30 mph).
- Grades may be increased by one percent for freeways in developed areas where a flatter grade is precluded.
- Where street lighting is present, the minimum length of sag vertical curve is three times the speed.
- For three lanes or more use: 10 foot right/10 foot left

### **2.6.2 Design Exceptions**

The conceptual alternatives were developed in accordance with design criteria requirements of both KYTC and ODOT. Due to the constraints of the urban study area and required connections to existing roadways, some design exceptions had to be incorporated into the conceptual alternatives. The design exceptions of each conceptual alternative are summarized below and presented in detail in Appendix C. In Step 6 of the PDP, the design exceptions will be revised or eliminated where feasible.

#### Alternative B

Two design exceptions would be necessary in Kentucky:

- The KY 9<sup>th</sup> Street on ramp to I-71/I-75 northbound has a 15 mph curve.
- I-71 southbound off ramp to KY 5<sup>th</sup> Street has a 20 mph curve.

Two design exceptions would be necessary in Ohio:

- I-71 northbound will require a design speed of 50 mph.
- I-71 southbound will require a design speed of 50 mph.

#### Alternative C

One design exception would be necessary in Kentucky:

- The KY 9<sup>th</sup> Street on ramp to I-71 northbound has a 20 mph curve.

Eight design exceptions would be necessary in Ohio:

- The under clearances for a northbound local C-D roadway and the railroad bridge are below the required 23 feet clearance requirement.
- I-71 southbound would require a design speed of 50 mph.
- Mainline I-75 would require a design speed of 55 mph in two roadway segments.
- US 50 eastbound would require design speeds of 45 and 50 mph in two horizontal segments and a design speed of 55 mph in four vertical segments.
- US 50 westbound would require a design speed of 45 mph in one horizontal segment and would require a design speed of 55 mph in three vertical segments.
- Western Ave to I-75 southbound would require a design speed of 25 mph.
- I-75 northbound to US 50 westbound would require a design speed of 35 mph.
- The C-D southbound roadway would require a design speed of 40 mph.

#### Alternative D

Alternative D would not require any design exceptions in Kentucky.

Five design exceptions would be necessary in Ohio:

- I-71 southbound would require a 7.5 percent grade with a 50 mph design speed. (Alternative C design will be utilized to reduce the 7.5 percent grade.)
- US 50 eastbound would require a design speed of 45 mph horizontally and a design speed of 55 mph vertically.
- US 50 westbound to I-75 NB would require a design speed of 40 mph.
- US 50 westbound would require a design speed of 50 mph.
- The under clearances for a northbound local C-D roadway, OH 2<sup>nd</sup> Street, OH 5<sup>th</sup> Street, and the railroad bridge are below the required 23 feet clearance requirement.

Alternative E

One design exception would be necessary in Kentucky:

- The KY 5<sup>th</sup> Street on ramp to I-71 northbound would require a 25 mph curve.

Four design exceptions would be necessary in Ohio:

- US 50 westbound to I-75 northbound would have several segments requiring design speeds of 50 and 55 mph.
- The C-D southbound ramp to I-75 southbound would require a design speed of 50 mph in one vertical segment.
- The C-D southbound roadway would require a design speed of 45 mph design speed for horizontal and vertical alignment.
- The C-D southbound to OH 2<sup>nd</sup> Street would require a design speed of 40 mph in one horizontal segment.
- I-71 southbound would require a design speed of 45 mph.
- I-71 northbound would require a design speed of 45.

Alternative G

One design exception would be necessary in Kentucky:

- The C-D roadway off ramp to KY 5<sup>th</sup> Street would require a 25 mph curve.

Three design exceptions would be necessary in Ohio:

- I-71 southbound would require a design speed of 45 mph.
- I-71 northbound would require a design speed of 50 mph for horizontal alignment.
- The C-D northbound to I-71 northbound would require a shoulder width design exception.

## **3.0 AFFECTED ENVIRONMENT**

### **3.1 Existing Roadway Network**

The existing roadway network within the study area consists of two interstates (I-71 and I-75), several US Routes (US 25, US 42, US 50, and US 127), two State Routes (KY 8 and OH 264), and numerous local streets. Major local streets and roads in Kentucky include Dixie Highway, Kyles Lane, KY 4<sup>th</sup>, 5<sup>th</sup>, 9<sup>th</sup>, and 12<sup>th</sup> streets, Pike Street, Crescent Avenue, Bullock Street, Jillians Way, and Philadelphia Street. In Ohio, major local streets include OH 2<sup>nd</sup>, 3<sup>rd</sup>, 4<sup>th</sup>, 5<sup>th</sup>, 6<sup>th</sup>, 7<sup>th</sup>, 8<sup>th</sup>, and 9<sup>th</sup> streets, Central Avenue, Gest Street, Linn Street, Freeman Avenue, Western Avenue, Winchell Avenue, Ezzard Charles Drive, Bank Street, Spring Grove Avenue, and Harrison Avenue. This roadway network serves both regional and local traffic within the Greater Cincinnati/Northern Kentucky region.

I-71 and I-75 are major north-south transportation corridors through the Midwestern United States. I-75 was constructed in the 1950's and the Brent Spence Bridge was completed in 1963. Since the construction of I-75, the Brent Spence Bridge deck was reconfigured to add a fourth travel lane in each direction in 1985. In 1998, I-71/I-75 in Kentucky was realigned and widened between the southern limits of the Brent Spence Bridge and Dixie Highway. I-71, also known as Fort Washington Way through downtown Cincinnati, was reconstructed in 2000 which included the reconfiguration of connections to I-75 and the US 50 interchange in Ohio. Even with the recent construction projects,

the I-75 corridor is characterized by outdated design, vehicular safety problems, and poor levels of service which threaten the overall efficiency of people and goods movement within the region. Congestion in both directions on I-75 is a regular occurrence throughout the entire study area and is often present at various times during the day.

### **3.1.1 Other Improvements to the I-75 Corridor**

In addition to the Brent Spence Bridge Replacement/Rehabilitation Project, there are two other projects taking place along the I-75 corridor in the Cincinnati area, the Mill Creek Expressway and the Thru-the-Valley project. These two ODOT projects are being conducted as part of an overall program to implement long term improvements to I-75. Primary goals of these programs are preserving right-of-way and, assuring that long term improvements made to the corridor build on each other, providing improved capacity.

The Mill Creek Expressway is adjacent to the northern limits of the Brent Spence Bridge Replacement/Rehabilitation Project. This project has a study area that extends from the I-75 and Seymour Avenue Interchange south to the Western Hills Viaduct where this project overlaps slightly with the Brent Spence Bridge Replacement/Rehabilitation Project. The Mill Creek Expressway project will improve traffic flow and enhance safety along the I-75 corridor. The Thru-the-Valley project is adjacent to the Mill Creek Expressway to the north. This project extends from the I-75/I-275 Interchange to the I-75 and Paddock Road, the northern limit of the Mill Creek Expressway. This project will also increase regional mobility while improving safety and easing congestion on I-75.

To assist these projects in improving safety and relieving congestion through the I-75 corridor in greater Cincinnati, ramp metering is being considered for all three projects. Ramp meters, are devices which are similar to traffic lights but with only two-phases: green and red. Combined with a signal controller, ramp metering restricts the flow of traffic entering a freeway, temporarily storing it on the entrance ramps. The intended effect of ramp metering is to reduce congestion on freeways by limiting the number of vehicles that can enter a freeway at one time. The ramp meters space out the vehicles entering the freeway, allowing these vehicles to merge with traffic more easily. Additionally, the delay caused by ramp metering for vehicles waiting to enter a freeway can serve as a deterrent, causing drivers to choose other routes, which would further contribute to reducing congestion on a freeway.

Ramp metering will be implemented at feasible locations along the I-75 corridor. Currently, ramp metering is being considered for ramps that have direct access to the interstate system. This includes both the northbound and southbound entrance ramps at the Western Hills Viaduct and the northbound entrance ramp at Bank Street in Ohio. Ramp metering is also being considered in Kentucky; however locations for ramp meters there have not yet been determined.

The utilization of a Collector-Distributor (C-D) roadway network will assist in alleviating the need for metered entrance ramps. This is because most entrance ramps will merge onto the C-D roadway prior to merging onto the interstate. The C-D roadway network can be designed to further restrict access to the interstate system if it is determined to be necessary to maintain a consistent level of traffic flow along the various segments of the

interstate. Ramp metering in Ohio and Kentucky will continue to be investigated throughout the Project Development Process.

### **3.2 Existing Traffic**

Currently, approximately 160,000 vehicles per day use the Brent Spence Bridge and traffic volumes are projected to increase to approximately 200,000 vehicles per day in 2035 for the No Build Alternative. The number of vehicles per day would be approximately 230,000 for the conceptual alternatives. Traffic data and levels of service information for 2005 and 2035 are provided in Appendix A.

The *Planning Study Report* (September 2006) provides detailed information of existing traffic conditions for 2005. The initial traffic counts were performed within the study area during the months of September, October, and November of 2005 in order to obtain existing weekday traffic volumes. Additional traffic counts were conducted in January 2008 to collect additional traffic data at the Dixie Highway Interchange due to expanding the project limits to include the interchange and along McMillan Avenue per the request of the City of Cincinnati. The traffic counts were converted to design hour volumes and the average daily traffic (ADT) volumes. The AM and PM peak hours were identified from the traffic counts and were used in the 2005 analyses for the study area.

The design hour traffic on I-71, I-75, and US 50 occurs during the 7:30 to 8:30 AM and 4:30 to 5:30 PM. Detailed results of the 2005 existing condition analyses performed on the mainline segments of I-75, I-71, and US 50 within the study area are presented in the *Planning Study Report*.

Capacity analyses are performed to estimate the maximum amount of traffic that can be accommodated by a roadway facility while maintaining prescribed operational qualities. This is accomplished using the level of service (LOS) concept. LOS is an assessment of roadway and intersection performance, expressed LOS A to F. LOS A represents free-flow conditions where vehicles are almost completely unimpeded in their ability to maneuver within the traffic stream. LOS E is defined as using all available capacity, where vehicles are closely spaced within the traffic stream and there are virtually no usable gaps to maneuver. LOS F exceeds the roadway's capacity and there is a breakdown of vehicle flow.

#### **3.2.1 Mainline Segment Analyses**

The mainline segments of I-75, I-71, and US 50 were divided into 54 segments for the 2005 existing conditions capacity analyses. The results of the analyses indicate that most segments operate at a LOS of C or D for the I-75 mainline. Of the 54 segments analyzed, 41 segments have a LOS of either C or D. Comparing the 2005 data to the 2035 No Build conditions, locations with a current LOS D will degrade to a LOS of E or F in the design year (2035) (Table 5).



**Table 5. Comparison of I-75 Freeway Segments between 2005 and 2035  
 No Build Conditions**

LOS	2005	2035 No Build
B	6	0
C	22	11
D	19	16
E	6	8
F	1	19

The LOS results for I-71 northbound and southbound for 2005 range from LOS B to LOS D. For the same segments, the 2035 No Build LOS range from LOS C to LOS F. The results for US 50 indicate a similar LOS degradation however, the LOS did not fall below LOS D on any segment.

### **3.2.2 Ramp-Freeway Junctions**

Traffic congestion throughout the highway network is also due to the merge and diverge locations at interchanges along I-75, I-71, and US 50. The *Planning Study Report* presents the results for the 2005 existing conditions analyses performed on interchange ramps of I-75, I-71, and US 50 within the study area. Locations with a LOS D are likely to degrade to a LOS of E or F in the design year (2035).

Traffic analyses determined that numerous interchanges on I-75 in the northbound and southbound directions currently operate at LOS D, E, and F during both the AM and the PM peak hours. Additionally, I-71 interchange ramps in the study area operate at LOS B to E during the AM and PM peak hours. The majority of ramps along US 50 operate at LOS A, B, and C in both the AM and PM peak hours.

### **3.2.3 Local Street At-Grade Intersections**

A total of 47 signalized and eight unsignalized local street intersections were analyzed within the study area. The *Planning Study Report* presents the results of the 2005 intersection analyses.

Most of the intersections in the study area currently operate at a LOS B and C. However, intersections adjacent to the Kyles Lane Interchange in Kentucky operate at LOS F during both the AM and PM peak periods. Several intersections in Kentucky operate at a LOS D. The West 3<sup>rd</sup> Street and Central Avenue intersection in Cincinnati operates at a LOS D during both AM and PM peak periods. The West 3<sup>rd</sup> Street and Clay Wade Bailey Bridge intersection in Cincinnati operates at LOS E during the PM peak hour.

### **3.2.4 Origin-Destination Studies**

During the development of the Brent Spence Bridge Replacement/Rehabilitation Project, two Origin-Destination (OD) studies were completed. The first OD study was completed in December 2005 to document and understand travel patterns and travel times of cars and trucks using the Brent Spence Bridge during morning, mid-afternoon, and evening peak periods. The results of this study are documented in *Origin-Destination Study* (March 17, 2006). The second OD study was completed in September 2006 to document and understand travel patterns between I-75, US-50, and Freeman Avenue.

The results of this study are documented *I-71/US-50 Origin-Destination Study* (January 2007). The two OD reports are located in Appendix F on CD.

#### **3.2.4.1 Origin-Destination Study 2005**

The primary purpose of the analysis was to assess the travel patterns between the Brent Spence Bridge and the I-75/I-275 interchange in Ohio via I-75; and I-471 at the Daniel Beard Bridge via Fort Washington Way. Additional analyses were performed to determine travel patterns for vehicles crossing the Brent Spence Bridge and having origins and destinations at I-71 southbound and northbound at Oak Street overpass; and US 50 eastbound and westbound from I-71/I-471 just east of I-471.

The OD study determined that approximately 40 percent of the cars using the Brent Spence Bridge were going to or coming from the four study locations:

- I-71 at Oak Street overpass (approximately 20 percent to 25 percent);
- I-75 at Crescentville overpass (approximately 5 percent to 10 percent);
- I-471 at Daniel Beard Bridge (approximately 3 percent to 7 percent); and
- US 50 Ramps to/from I-71/I-75/I-471 (east of Daniel Beard Bridge, approximately 1 percent to 5 percent).

The remaining 60 percent of cars were going to or coming from unknown locations.

The percentage of trucks remaining on the interstate system was higher than that of passenger vehicles. At least 70 percent of trucks using the Brent Spence Bridge were going to or coming from the four study sites:

- I-71 at Oak Street overpass (approximately 20 percent to 30 percent);
- I-75 at Crescentville overpass (approximately 45 percent to 70 percent);
- I-471 at Daniel Beard Bridge (approximately 1 percent to 8 percent); and
- US 50 Ramps (east of Daniel Beard Bridge, approximately 1 percent to 5 percent).

The remaining 30 percent of trucks were going to, or coming from unknown locations.

#### **3.2.4.2 I-71/US 50 Origin-Destination Study 2006**

The 2006 study was performed to establish travel patterns of cars and trucks between I-75 and US 50, using Freeman Avenue, during the morning, mid-day, and evening peak periods. The study findings indicate the following travel patterns.

##### I-75 Southbound Off Ramp to US-50 Westbound On Ramp

- During the morning, mid-day, and evening peak periods 19 percent to 52 percent of automobiles leaving I-75 on the southbound off ramp enter the US 50 westbound on ramp through Freeman Avenue.
- During the morning, mid-day, and evening peak periods 23 percent to 29 percent of trucks leaving I-75 on the southbound off ramp enter US 50 westbound on ramp through Freeman Avenue.

During the morning, mid-day, and evening peak periods, the remaining automobiles, ranging from 48 to 81 percent and the remaining trucks, ranging from 71 to 77 percent leave I-75 on the southbound off ramp to other locations.

#### US 50 Eastbound Off Ramp to I-75 Northbound On Ramp

- During the morning, mid-day, and evening peak periods 62 to 74 percent of automobiles leaving US 50 on the eastbound off ramp enter I-75 by the northbound on ramp through Freeman Avenue.
- During the morning, mid-day, and evening peak periods 85 to 100 of trucks leaving US 50 by the eastbound off ramp enter I-75 by the northbound on ramp through Freeman Avenue.

During the morning, mid-day, and evening peak periods, the remaining automobiles, ranging from 26 to 38 percent and the remaining trucks, ranging from 0 to 15 percent leave US 50 by the eastbound off ramp to other locations.

### **3.3 Social Environment**

#### **3.3.1 Neighborhood and Community Cohesion**

The study area encompasses several communities within the Greater Cincinnati/Northern Kentucky region (Exhibit 11A – 11E). The study area goes through the cities of Fort Wright, Park Hills, and Covington within Kentucky and the City of Cincinnati in Ohio. Many Covington and Cincinnati neighborhoods are cohesive communities with significant history and community infrastructure. There are several residential communities along the interstate corridor in the City of Covington. These include Kenton Hills, Lewisburg, and West Covington located west of I-71/I-75 and Peaseburg, West Side, and Mainstrasse located east of I-71/I-75. In Cincinnati, these neighborhoods include Queensgate, West End, Fairview-Clifton Heights, and Camp Washington. With the exception of the I-71/I-75 Interstate itself and the Ohio River, no physical barriers exist between neighborhoods and the Central Business Districts within Cincinnati and Covington.

Census tract data were used to assess population conditions within the study area in both Kentucky and Ohio. There are 22 Census tracts within the study area. Population has decreased throughout the majority of the study area resulting in a net decrease in population between 1990 and 2000. Overall, the decline was more than 11 percent or approximately 5,200 persons. The study area population decline during the same time period is more than that of the City of Cincinnati (9 percent decline) and Hamilton County (2.4 percent decline). In contrast, northern Kentucky has experienced an increase in population between 1990 and 2000. The City of Covington has experienced a 0.2 percent increase and Kenton County has had a 6.6 percent increase in population between 1990 and 2000.

According to the Census data, approximately 23 percent of Cincinnati and 22 percent of Covington households do not own a car. However within the study area, a greater percentage (35 percent) of all households does not own a car. The majority of employees within the study area use their automobile to travel to work. The percentage

of workers that use public transportation in the study area is higher in Cincinnati than in Covington.

**3.3.2 Environmental Justice**

Environmental justice (EJ) communities are areas where there is a high percentage of low-income or minority populations. Based on Ohio Kentucky Indiana Regional Council of Governments EJ Policy (2003), 25 percent above the regional average is used as the benchmark to note Census tracts with high percentages of environmental justice populations. Low-income and minority populations are found within the study area in both Covington and Cincinnati (Exhibit 12A – 12D).

The Kentucky portion of the study area has moderate levels of low-income and minority populations. In general, the population is predominately white, approximately 85 percent, with a median household income range of \$19,000 to \$47,000. The largest minority populations in this portion of the study area are located east of I-75 between KY 9<sup>th</sup> Street and Pike Street and in the Peaselburg neighborhood. High concentrations of low-income populations are in the Peaselburg and Mainstrasse neighborhoods.

The City of Cincinnati has several Census tracts of densely populated minority and low-income areas. The areas east of the existing interstate corridor in Cincinnati are diverse relative to both income and ethnicity. Some Census tracts show poverty levels as high as 70 percent. These areas are located in the northeastern portion of the study area. Similarly, some tracts in the northeast part of the study area show minority levels of 90 to 100 percent. Large minority areas are located immediately adjacent to the existing I-75 corridor in the West End and Queensgate neighborhoods.

**3.3.3 Community Services and Facilities**

Community services and facilities within the study area include parks, schools, hospitals, police stations, fire stations, libraries, cemeteries, government buildings, entertainment, and religious institutions. These resources are presented in Table 6 and shown on Exhibit 11A – 11E.

**Table 6. Community Facilities and Services**

<b>Kentucky</b>		
<b>Attraction</b>	<b>Location</b>	<b>Description</b>
1. Garden of Hope	699 Edgecliff Road, Covington	Recreation of the Garden Tomb in Jerusalem
<b>Churches/Religious</b>	<b>Location</b>	<b>Description</b>
2. St. John's Catholic Church	627 Pike Street, Covington	Catholic Church
3. Central Church of the Nazarene	2006 Pieck Drive, Fort Wright	Church of the Nazarene
<b>Nursing Home</b>	<b>Location</b>	<b>Description</b>
4. Baptist Life Communities	800 Highland Avenue, Covington	Nursing Home

**Table 6. Community Facilities and Services**

<b>Recreation</b>	<b>Location</b>	<b>Description</b>
5. Kenney Shields Park	West KY 9 <sup>th</sup> Street and Philadelphia Street, Covington	Small neighborhood corner lot with playground equipment - Owned by the City of Covington
6. Neighborhood Pool	West KY 8 <sup>th</sup> Street and Dalton Avenue, Covington	Neighborhood pool - Owned by the City of Covington
7. Devou Park/Golf Course/Overlook	1344 Audubon Road, Covington	700-acre park and golf course - Owned by the City of Covington
8. Goebel Park/Mainstrasse Village District	KY 6 <sup>th</sup> Street Area of Covington	Park area and surrounding retail and restaurants - Owned by the City of Covington
9. Neighborhood Park	West KY 11 <sup>th</sup> Street and Hermes Avenue, Covington	Owned by the City of Covington
<b>School</b>	<b>Location</b>	<b>Description</b>
10. Notre Dame Academy	1699 Hilton Drive, Park Hills	Parochial College Prep High School - 594 female students
11. Prince of Peace Catholic School	625 Pike Street, Covington	Parochial Grade School – Grades K – 8
<b>New Development</b>	<b>Location</b>	<b>Description</b>
Saint Elizabeth Medical Center	South of KY 12 <sup>th</sup> Street, Covington	Hospital campus – Under construction
<b>Ohio</b>		
<b>Attraction</b>	<b>Location</b>	<b>Description</b>
12. Paul Brown Stadium	One Paul Brown Stadium	Pro Football Facility – Home of NFL Cincinnati Bengals
13. National Underground Railroad Freedom Center	50 East Freedom Way, Cincinnati	Museum
14. Great American Ball Park	100 Main Street, Cincinnati	Pro Baseball Facility – Home of MLB Cincinnati Reds
15. US Bank Arena	100 Broadway, Cincinnati	Multi-purpose facility
16. Cinergy Center	525 Elm Street, Cincinnati	Convention and Exhibition Facility
17. Cincinnati Fire Museum	315 West Court Street, Cincinnati	Museum
18. Geier Research and Collections Museum	760 West OH 5 <sup>th</sup> Street, Cincinnati	Museum
19. Union Terminal	1301 Western Avenue, Cincinnati	Omnimax Theatre, Museum Center, Children's Museum, Natural History Museum, Amtrak
<b>Churches/Religious</b>	<b>Location</b>	<b>Description</b>
20. York Street United Methodist	816 York Street, Cincinnati	Methodist Church
21. Plum Street Temple	726 Plum Street, Cincinnati	Jewish Temple
22. St. Peter in Chains Cathedral	325 West OH 8 <sup>th</sup> Street, Cincinnati	Catholic Church
23. Jarriel Baptist Church	Wesley and Court streets, Cincinnati	Baptist Church

**Table 6. Community Facilities and Services**

<b>Fire Station</b>	<b>Location</b>	<b>Description</b>
24. Fire House - Company 14	OH 5 <sup>th</sup> and Central, Cincinnati	Fire House
25. Fire House - Company 29, Ladder 29	564 West Liberty at Linn Street, Cincinnati	Fire House
<b>Government Building</b>	<b>Location</b>	<b>Description</b>
26. Cincinnati City Hall	801 Plum Street, Cincinnati	Offices of Mayor, City Manager, City Council, administration, etc.
27. Jail - Hamilton County Queensgate Facility	516 Linn Street, Cincinnati	Correctional Facility (recently closed)
<b>Library</b>	<b>Location</b>	<b>Description</b>
28. Public Library of Cincinnati and Hamilton County	805 Ezzard Charles Drive, Cincinnati	Public Library
29. Lloyd Library and Museum	917 Plum Street, Cincinnati	Botanical, Medical, Pharmaceutical, and Scientific books
<b>Public Agency</b>	<b>Location</b>	<b>Description</b>
30. Cincinnati Job Corp Center	1409 Western Avenue, Cincinnati	Training Facility and Dorms
<b>Post Office</b>	<b>Location</b>	<b>Description</b>
31. Main Post Office - Dalton Avenue	1623 Dalton Avenue, Cincinnati	Post Office Facility
32. Post Office Branch	Dalton Avenue and Gest Street, Cincinnati	Post Office Facility-Mid City Carrier Unit
<b>Recreation</b>	<b>Location</b>	<b>Description</b>
33. Lincoln Park - Union Terminal	Freeman Avenue and Ezzard Charles Drive, Cincinnati	Owned by the City of Cincinnati - Operated by Cincinnati Park Board - Greenspace
34. Park at Derrick Turnbow and Linn Street	1525 Linn Street, Cincinnati	Behind apartment buildings and a strip shopping center - Owned by the City of Cincinnati
35. Dyer Park	Baymiller Street and Bank Street, Cincinnati	Ball Field, Pool and Playground - Owned by the City of Cincinnati - Operated by Cincinnati Recreation Commission
36. Lincoln Community Center	1027 Linn Street, Cincinnati	Pool, playground, tennis court, basketball courts -Owned by the City of Cincinnati - Operated by Cincinnati Recreation Commission
37. Queensgate Playground and Ballfields	707 West Court Street, Cincinnati	Playground and ballfields – Owned by the City of Cincinnati - Operated by Cincinnati Recreation Commission
<b>School</b>	<b>Location</b>	<b>Description</b>
38. St. Joseph's Catholic School	805 Ezzard Charles Drive, Cincinnati	Parochial Elementary School

**Table 6. Community Facilities and Services**

39. Cincinnati Hamilton County Community Action Agency	880 West Court Street, Cincinnati	Theodore M. Berry Head Start Program
40. Lafayette Bloom B-O-T Accelerated Middle	1941 Baymiller Street, Cincinnati	Cincinnati Public School - Grades 6-8
41. Heberle Elementary	2015 Freeman Avenue, Cincinnati	Cincinnati Public School - Preschool – 8
<b>TV/Radio Station</b>	<b>Location</b>	<b>Description</b>
42. WXIX - TV	635 West 7 <sup>th</sup> Street, Cincinnati	Network TV Station

Note: Site numbers correspond to site numbers on Exhibit 11A – 11E

### **3.3.4 Land Use**

The study area is both urban and suburban in nature. The primary land uses within the study area are commercial, industrial, residential, institutional, and existing roadway rights of way (Exhibit 13A – 13B). No farmland is present in Ohio within the study area.

Land use in the Kentucky portion of the study area is residential and commercial with pockets of industrial and limited agriculture uses. Commercial uses are concentrated at the KY 5<sup>th</sup> Street and Pike Street exits of I-71/I-75. Open space uses include agricultural, parks and golf courses.

Land use in the Ohio portion of the study area is mostly commercial, residential and industrial. The Cincinnati central business district (CBD) is partially located within the study area and is accessible by I-75. West of I-75, land use is primarily industrial with commercial and office uses located near Gest Street. East of I-75, land uses are almost entirely residential and institutional.

### **3.3.5 Economy and Employment**

#### **3.3.5.1 Employment**

Employment data for the study area are discussed in the *Existing and Future Conditions Report* (February, 2006). Within the study area, the largest employment sector is Educational and Health Services which is consistent with the region. Within one mile of the existing Brent Spence Bridge there were 37,687 people employed in 2008. The unemployment rates for the cities of Covington and Cincinnati are 6.2 percent and 7.3 percent respectively. Unemployment rates among Census tracts in Kentucky within the study area extend across the range from being lower to being higher than the Covington unemployment rate. All of the Census tracts in Cincinnati have unemployment rates higher than these averages.

In Kentucky, the largest employers include the City of Covington and Saint Elizabeth Hospital. Other businesses with large numbers of employees in the study area include Kerry Toyota, Lexus Car Sales and Service, and multiple hotels. The largest employers within the study area are all located in Ohio and include the City of Cincinnati, Butternut Brands, Duke Energy, Fox 19 Television, and United Parcel Service in Ohio.

### **3.3.5.2 Highway-Related Businesses**

Highway-related businesses include gas stations/service stations, convenience stations, restaurants/drive-thru, hotels/motels, and any other type of business that caters to local and regional traffic. Highway-related businesses in the study area in Kentucky are primarily located at the KY 5<sup>th</sup> Street exit of I-71/I-75. This exit is the only food and gas exit on southbound I-71/I-75 between the Ohio River and Kyles Lane in Kentucky. Highway-related businesses in the study area in Ohio are located at exits south of Ezzard Charles Drive. Specifically, these businesses include hotels and convenience stores. The Gest Street exit provides access to a cluster of highway-related businesses, including a hotel.

### **3.3.5.3 Business Districts**

Established business districts within the study area in Kentucky include Mainstrasse/Covington and clusters of businesses in Lewisburg, Park Hills, and Kenton Hills. Established business districts within Ohio include Queensgate and Cincinnati Central Business District. Clusters of businesses are also located in Lower Price Hill, West End, Storrs, and Clifton Heights in Ohio. While not all of these business districts are within the study area, they may be affected by altered access to and from I-75.

## **3.4 Natural Environment**

### **3.4.1 Geotechnical**

*The Red Flag Summary Report* (December 2005) and *Existing and Future Conditions Report* (February 2006) both provide a detailed discussion of existing geotechnical issues in the study area.

#### **3.4.1.1 Geology**

The overall study area has been affected by major glaciations occurring during the Pleistocene Epoch. These glacial advances caused profound drainage changes and were responsible for the deposition of a variety of soils lying beneath the Covington/Cincinnati area.

In the Kentucky portion of the study area, soils consist of a gravelly zone topped by granular outwash deposits. Near-surface soils contain alluvial sediments, deposited by the floodwaters of both the Ohio and Licking rivers. Man has also affected soil conditions within the study area by placement of fill, construction of buildings, construction of marina and housing developments, demolition of structures, and roadway grading.

In the Ohio portion of the study area, geology predominantly consists of a combination of alluvium and outwash soils, with minor amount of lacustrine (lakebed) and glacial till deposits. The western portion of the study area consists of recent alluvium and alluvial terraces deposited in present and former floodplains. The alluvial deposits ranged from silty clays, sands, gravels, and silty sands. Along the eastern side of the study area, the predominant geology consist of Late Wisconsinian Age outwash soils from the Ohio River to approximately 1.5 miles north of the Ohio River.

There are no mapped coal mines within the corridor area. In this region, solutioned limestone, or karst, sometimes develops in upland areas where limestone is the



predominant bedrock formation. The Northern Kentucky region is within an area with limited to moderate potential for karst. Based on local experience, the development of karst in the project corridor area may occur in isolated areas, but is not anticipated to be a significant concern.

#### **3.4.1.2 Soil Test Borings**

Details of geotechnical investigations are presented in the *Report of Preliminary Geotechnical Study: Proposed Queensgate Alignment* (July 2007). This report provides general subsurface information for Alternatives A and B through the Queensgate area and characterizes subsurface soil conditions.

Test borings performed in 1958 for the existing Brent Spence Bridge were reviewed as part of the geotechnical studies. The test borings from 1958 encountered cohesive materials and granular materials. Bedrock was encountered in each of the river bottom borings, bedrock was not encountered in any of the river bank borings.

In 2007, six test borings were located along Alternatives A and B in Queensgate during geotechnical investigations. The test borings were performed to obtain a general subsurface profile along the conceptual alternative alignments and to determine the depth to bedrock.

As part of the geotechnical investigations, environmental screening of the recovered soil/sediment samples was performed in the field at the time of drilling or immediately upon return to the soils laboratory. The samples were screened for the presence of organic vapors, which could potentially be attributable to contaminants. Based on the overall field screening readings, visual observations, and general lack of odors, it appears unlikely that the samples at the test boring locations are significantly environmentally impacted. It should be noted however, that the presence of heavy metals cannot be determined unless further analysis is performed.

#### **3.4.1.3 Geological Hazards**

Areas of the Greater Cincinnati/Northern Kentucky region are prone to slope movements and landslides. Numerous landslides have been reported and documented on the Kentucky portion of the study area. The landslides typically occur along the western side of the study area and near the southern limits from about Kyles Lane to about 1.5 miles north of Kyles Lane (Exhibit 14A – 14B). Due to the hilly terrain in these areas, slope instability is common. Landslides sometimes occur after heavy rain events or during extended periods of wet weather. The landslides generally occur above the bedrock within the overburdened soils or along the soil/bedrock interface. With the widening of I-71/I-75 to the west within this area, there is a potential for slope movements and landslides during and after construction. Stability of excavated slopes in this area will be addressed throughout the Project Development Process.

After the original construction of I-71/I-75 in Kentucky (between Kyles Lane and KY 12<sup>th</sup> Street) the outside northbound lane started to show signs of settlement and cracking. The distress was initial evidence of a landslide along the eastern side of I-71/I-75 (Exhibit 14A). A large buttress embankment was constructed to stabilize the slope in this area. Additionally, the existing roadway embankment was constructed on a substantial depth of colluvium, which in turn overlaid a sloping bedrock surface. Stability

of the slopes in this area will need to be monitored during and after construction for signs of distress.

Few, if any, landslides have been reported along the eastern side of the corridor (near the Ohio River) in Kentucky, and in the entire study area in Ohio. In these relatively flat areas, the greatest potential for landslide or slope instability is adjacent to the Ohio River. The Ohio River riverbank has a history of shallow sloughing and flood events have an impact on their overall short-term and long-term stability. Rapid drawdown and its impact, especially on the riverbanks and where loess is exposed, is an important stability issue, which will require detailed investigation and analysis throughout the project development process.

At-grade roadways can generally be constructed on suitable natural soils or new structural fill. It is anticipated that minimal cut/fill will be required if the I-71/I-75 improvements generally follow the current interstate alignment except where the I-71/I75 roadway alignment is shifted to the west between Kyles Lane and KY 12<sup>th</sup> Street to avoid the large buttress embankment noted above. If the mainline is shifted significantly to the west in Kentucky as presented in Alternative B, deeper cuts, including rock excavation is anticipated along Western Avenue and Crescent Avenue between KY 3<sup>rd</sup> Street and KY 9<sup>th</sup> Street (Exhibit 14A – 14B). As a result of anticipated deeper cuts and rock excavation, this area would be susceptible to potential slope movements and landslides in the future.

The presence of random fill, old structures, and moderately compressible overburden soils in some portions of the study area may warrant the need for ground modification. Various techniques for ground modification and/or improvement can be used and are anticipated.

### **3.4.2 Aquatic Resources**

Aquatic resources in the study area are limited to the Ohio River, seven intermittent streams, four ephemeral streams, and one open water pond (Exhibit 15A – 15D). Intermittent and ephemeral stream lengths in the study area total 6,700 and 975 linear feet, respectively. The open water pond is 0.69 acres in size. These streams and pond are located in Kentucky. Tributaries to the Ohio River that may have historically existed in Ohio have been either filled or incorporated into the underground storm sewer network. There are no designated wild and scenic rivers, outstanding resource waters, high quality fishing streams, or spawning areas in the study area. Detailed descriptions of the aquatic resources within the study area are discussed in the *Project Level One Ecological Survey Report – Kentucky* (February 2007) and *Project Level One Ecological Survey Report – Ohio* (February 2007).

### **3.4.3 Wetlands**

Wetland delineations were completed following the guidelines of the *Corps of Engineers Corps of Engineers Wetlands Delineation Manual* (US Army Corps of Engineers [USACE] 1987). Data on soils, hydrology, and vegetation were collected and boundaries mapped using a Global Positioning System (GPS). Jurisdictional Determination verification by USACE has not been completed.

There are eight wetlands in the Kentucky portion of the study area, which total 1.98 acres (Exhibit 15A – 15C). There are no wetlands in the Ohio portion of the study area.

All of the wetlands are low quality palustrine emergent wetlands. Two of the wetlands are isolated wetlands and six of the wetlands are hydrologically connected to streams or drainage ways. Detailed descriptions of the wetlands within the study area are discussed in the *Project Level One Ecological Survey Report – Kentucky* (February 2007) and the *Project Level One Ecological Survey Report – Ohio* (February 2007).

#### **3.4.4 Terrestrial Resources**

The majority of the study area is occupied by intensively developed urban land, including commercial, residential, and industrial uses. Additionally, transportation facilities (e.g., highways, streets, railways) and maintained lawns are also present within the study area. Detailed descriptions of the terrestrial ecology within the study area are discussed in the *Project Level One Ecological Survey Report – Kentucky* (February 2007) and the *Project Level One Ecological Survey Report – Ohio* (February 2007).

In the Kentucky portion of the study area, terrestrial habitats are urban in nature but have a mixed age woods component that likely has not been cleared in the past 30 to 40 years. Understory species within the mixed-age woods are dominated by invasive species such as bush honeysuckle (*Lonicera tatarica*) and wintercreeper (*Euonymus fortunei*), which are indicative of a previously disturbed habitat. North of the Ohio River terrestrial habitats are limited to a narrow, wooded riparian zone consisting of young trees and shrubs located along portions of the Ohio River and scrub shrub areas along the existing interstate right of way (Exhibit 15A – 15D).

#### **3.4.5 Threatened and Endangered Species**

The study area lies within the ranges of several federal and state-listed species. However, there are no documented populations of threatened and endangered species or critical habitat within the study area. Threatened and endangered species habitat surveys conducted in 2006 determined that potential habitat characteristics for the Indiana bat, running buffalo clover, riverbank paspalum, Kirtland’s snake, Virginia mallow, several bird species, and freshwater mussels exist within the study area (Table 7). According to state and federal resource agencies, the majority of the Ohio River species have not been collected or identified within the Ohio River since 1966 and are believed to no longer exist in the river. The potential presence of endangered mussel species in the Ohio River will require specific mussel surveys to determine impacts to any species.

**Table 7. Federal and State Listed Threatened and Endangered Species with Potential Habitat in the Study Area**

<b>County, State</b>	<b>Group</b>	<b>Common Name</b>	<b>Scientific Name</b>	<b>Federal Status</b>	<b>State Status</b>
Kenton, KY	Mammal	Indiana Bat	<i>Myotis sodalis</i>	Endangered	Endangered
Hamilton, OH	Bird	Black-crowned Night Heron	<i>Nycticorax nycticorax</i>	None	Threatened
Kenton, KY	Bird	Savannah Sparrow	<i>Passerculus sandwichensis</i>	None	Special Concern
Kenton, KY	Bird	Bachman’s Sparrow	<i>Aimophila aestivalis</i>	Species of Management Concern	Endangered
Kenton, KY	Bird	Vesper Sparrow	<i>Pooecetes gramineus</i>	None	Endangered

**Table 7. Federal and State Listed Threatened and Endangered Species with Potential Habitat in the Study Area**

<b>County, State</b>	<b>Group</b>	<b>Common Name</b>	<b>Scientific Name</b>	<b>Federal Status</b>	<b>State Status</b>
Hamilton, OH	Plant	Riverbank Paspalum	<i>Paspalum fluitans</i>	None	Potentially Threatened
Kenton, KY	Plant	Running Buffalo Clover	<i>Trifolium Stoloniferum</i>	Endangered	Endangered
Hamilton, OH	Plant	Virginia Mallow	<i>Sida hermaphrodita</i>	None	Potentially Threatened
Kenton, KY	Mussel	Fanshell	<i>Cyprogenia stegaria</i>	Endangered	Endangered
Kenton, KY	Mussel	Spectaclecase	<i>Cumberlandia monodonta</i>	None	Endangered
Kenton, KY	Mussel	Clubshell	<i>Pleurobema clava</i>	Endangered	Endangered
Kenton, KY	Mussel	Black Buffalo	<i>Ictiobus niger</i>	None	Special Concern
Kenton, KY	Mussel	Snuffbox	<i>Epioblasma triquetra</i>	None	Endangered
Kenton, KY	Mussel	Longsolid	<i>Fusconaia subrotunda subrotunda</i>	None	Special Concern
Kenton, KY	Mussel	Pocketbook	<i>Lampsilis ovata</i>	None	Endangered
Kenton, KY	Mussel	Northern Riffleshell	<i>Epioblasma torulosa rangiana</i>	Endangered	Endangered
Kenton, KY	Mussel	Orangefoot Pimpleback	<i>Plethobasus cooperianus</i>	Endangered	Endangered
Kenton, KY	Mussel	Sheepnose	<i>Plethobasus cyphus</i>	Candidate	Endangered
Kenton, KY	Mussel	Pyramid Pigtoe	<i>Pleurobema rubrum</i>	None	Endangered
Kenton, KY	Mussel	Rough Pigtoe	<i>Pleurobema plenum</i>	Endangered	Endangered
Kenton, KY	Mussel	Catspaw	<i>Epioblasma obliquata obliquata</i>	Endangered	Endangered
Kenton, KY	Mussel	Rabbitsfoot	<i>Quadrula cylindrica cylindrica</i>	None	Threatened
Kenton, KY	Mussel	Pink Mucket	<i>Lampsilis abrupta</i>	Endangered	Endangered
Kenton, KY	Mussel	Ring Pink	<i>Obovaria retusa</i>	Endangered	Endangered
Hamilton, OH	Fishes	River Darter	<i>Percina shumardi</i>	None	Threatened
Hamilton, OH; Kenton, KY	Fishes	Lake Sturgeon	<i>Acipenser fulvescens</i>	None	Endangered
Kenton, KY	Amphibians	Eastern Hellbender	<i>Cryptobranchus alleganiensis alleganiensis</i>	None	Special Concern

**Table 7. Federal and State Listed Threatened and Endangered Species with Potential Habitat in the Study Area**

County, State	Group	Common Name	Scientific Name	Federal Status	State Status
Kenton, KY	Amphibians	Redback Salamander	<i>Plethodon cinereus</i>	None	Special Concern
Kenton, KY	Amphibians	Northern Leopard Frog	<i>Rana pipiens</i>	None	Special Concern
Hamilton, OH; Kenton, KY	Reptiles	Kirtland's Snake	<i>Clonophis kirtlandii</i>	None	Threatened

### 3.4.6 Floodplains

Floodplains are located along the north and south banks of the Ohio River within the study area (Exhibit 15A – 15D). The 100-year flood elevation is 498.5 feet. Approximately 12.5 acres of the 100-year floodplain are on the south side of the river in Kentucky and 168 acres of the 100-year floodplain are on the north side of the river in Ohio.

### 3.5 Cultural Resources

A literature search and history/architecture surveys of the Area of Potential Effects (APE) within Kenton County, Kentucky and Hamilton County, Ohio were conducted for the Brent Spence Bridge Replacement/Rehabilitation Project. The results of these investigations are documented in three reports: *Phase I History/Architecture Survey – Kenton County, Kentucky* (November 2008); *Phase I History/Architecture Survey – Hamilton County, Ohio* (June 2007); and *Phase II History/Architecture Survey – Hamilton County, Ohio* (October 2008).

The southern portion of the study area was extended after the historic survey field investigations were completed. In step 6 of the PDP, the APE within Kentucky will be extended to the south to include the Dixie Highway Interchange. A phase I historic architecture survey will be completed in this portion of the study area in Step 6. The information collected within this extended portion of the APE will not affect the recommendations of this *Conceptual Alternative Study* since impacts would be the same for all alternatives.

The project APE is largely defined by pre- and post-1960 resources along the current alignment for I-75 (Exhibit 16A – 16E). Within Kentucky, the majority of the resources that are more than 50 years old are located within the West Side/Main Strasse and Lewisburg historic districts. Within Ohio, the majority of the resources that are more than 50 years old are located within the Dayton Street and West Fourth Street historic districts.

In Kentucky there are five historic resources within or in close proximity to the APE listed on the National Register of Historic Places (NRHP):

- Kenney's Crossing
- Westside/Mainstrasse Historic District

**ODOT PID 75119**  
**KYTC Item No. 6-17**  
**Conceptual Alternatives Study**

---

- Lewisburg Historic District
- Bavarian Brewing Company
- Fort Mitchell Historic District

Additionally, there are 11 properties in Kentucky determined potentially eligible for the NRHP (Table 8).

In Ohio there are three individual properties and two historic districts listed on the NRHP within the APE. One of the resources, Union Terminal, is a National Historic Landmark.

- Union Terminal
- Our Lady of Mercy
- Longworth Hall (Baltimore & Ohio Railroad Freight Station and Storage Warehouse)
- Dayton Street Historic District
- West Fourth Street Historic District and Amendment

Additionally, there are three properties in Ohio determined eligible and one property potentially eligible for listing on the NRHP (Table 9).

**Table 8. Kentucky Architectural Properties Listed or Eligible for Listing in the NRHP**

<b>Resource Number</b>	<b>Name</b>	<b>Address</b>	<b>Construction Date/ Condition</b>	<b>National Register/ Landmark Status</b>
KEC 50, NRHP No. 90000481	Kenney's Crossing	1001 Highway Avenue	1880/Excellent	NRHP 1990
KEC 107	C&O Railroad Bridge	Spans Ohio River east of Brent Spence Bridge	1929/Good	Eligible 2008
KE 319	Joseph Kuchle House	3 Kyles Lane	1902/Good	Eligible 2008
KECL 817	Boehmer Decorating Center	533-535 Pike Street	Ca. 1870/Good	Eligible 2008
NRHP No. 83003650	Westside/Main Strasse Historic District	Various	1840-1877/Good	NRHP 1983
NRHP No. 93001165	Lewisburg Historic District	Various	1870-1880/Good	NRHP 1993
NRHP No. 96000281	Bavarian Brewing Company	522 West 12 <sup>th</sup> Street	1894-1966/Good	NRHP 1996
NRHP No. 89001170	Fort Mitchell Historic District	Various	1905-1929 and post World War II/ Excellent	NRHP 1989
KECL 1018	Residence	521 Western Avenue	1870/Excellent	Eligible 2008
KEC 462	Glier's Goetta	533 Goetta Place	1903/Excellent	Eligible 2008
KE 4	Kennedy-Rivard House	50 Rivard Drive	1850/Excellent	Kentucky Landmark 1995/ NRHP Eligible 2009
KECL 621	Residence	504 West 12 <sup>th</sup> Street	Ca. 1885/Good	Potentially Eligible 2009
KECL 626	Residence	514 West 12 <sup>th</sup> Street	Ca. 1880/Good	Potentially Eligible 2009
KECL 628	Residence	516 West 12 <sup>th</sup> Street	Ca. 1885/Good	Potentially Eligible 2009
KEC 460	Residence	881 Highway Avenue	Ca. 1870	Potentially Eligible 2009
KECL 1046	Residence	632 Western Avenue	Ca. 1920	Potentially Eligible 2009

**Table 9. Ohio Architectural Properties Listed or Eligible for Listing in the NRHP**

<b>Resource Number</b>	<b>Name</b>	<b>Address</b>	<b>Construction Date/ Condition</b>	<b>National Register/ Landmark Status</b>
HAM-1295-43 NRHP No. 72001018	Union Terminal	1301 Western Avenue	1933/ Excellent	NRHP 1972, National Historic Landmark 1977
HAM-1342-43	Harriet Beecher Stowe Elementary School (Fox 19 TV Station)	635 West 7 <sup>th</sup> Street.	1921/ Excellent	Eligible 2008
HAM-1656-43 NRHP No. 86003521	Longworth Hall (Baltimore Ohio RR – Freight)	700 Pete Rose Way	1904/ Rehabilitated	NRHP 1986
HAM-1709-40	Chem-Pack Inc.	2261 Spring Grove Avenue	1890/ Good	Eligible 2007
HAM-1804-43 NRHP No. 80003070	Our Lady of Mercy	1409 Western Avenue	1897/ Altered	NRHP 1980
--	John Mueller House	724 Mehring Way	1877/ Deteriorated	Eligible 2007
NRHP No. 73001457	Dayton Street Historic District	West End	1860-1880/ Good	NRHP Listed 1973
NRHP Nos. 76001443 and 79001861	West Fourth Street Historic District and Amendment	Central Business District	1870-1927/ Excellent	NRHP Listed 1976 Amended 1979
--	West Virginia Coal and Coke Building	725 Front Street	To be determined	Potentially Eligible 2009

### **3.6 Section 4(f) Resources**

Section 4(f) of the Department of Transportation Act of 1966, as amended in 1983 (49 U.S.C. Section 303) was enacted to preserve publicly owned land used for recreation, wildlife, and waterfowl refuges. Section 4(f) properties are publicly owned parks, wildlife management areas, historic resources that are listed on or eligible for listing on the NRHP; and archaeological sites that are listed on or eligible for listing on the NRHP and warrant preservation in place.

Section 4(f) resources in the study area are listed in Table 10 and Table 11. These resources are also shown on Exhibits 11A – 11E; 16A – 16B; and 17A - 17B.



**Table 10. Section 4(f) Resources in Kentucky**

Name	Address	Description
Devou Park/Golf Course/Overlook	1344 Audubon Road, Covington	700-acre park and golf course - Owned by the City of Covington
Goebel Park	KY 6 <sup>th</sup> Street Area of Covington	Park area and surrounding retail and restaurants - Owned by City of Covington
Kenney Shields Park	West KY 9 <sup>th</sup> and Philadelphia, Covington	Small neighborhood corner lot with playground equipment - Owned by the City of Covington
Neighborhood Pool	West KY 8 <sup>th</sup> and Dalton Avenue, Covington	Neighborhood pool - Owned by the City of Covington
Neighborhood Park	West KY 11 <sup>th</sup> and Hermes Avenue, Covington	Owned by the City of Covington
Westside/Main Strasse Historic District	Various	The district includes 910 acres and, 798 buildings constructed between 1840-1877; Listed in the NRHP in 1983
Lewisburg Historic District	Various	The district includes 700 acres, 430 buildings, and 48 non-contributing buildings. Most of the buildings were constructed in the 1870's and 1880's; Listed in the NRHP in 1993
Bavarian Brewing Company	522 West 12 <sup>th</sup> Street	Industrial complex, local manufacturer of beer from 1894 to 1966; Listed in the NRHP in 1996
Kenney's Crossing	1001 Highway Avenue	Residence constructed in 1880; Listed in the NRHP in 1990
Fort Mitchell Historic District	Various	The district includes 300 acres, 22 buildings, and one structure constructed between 1905-1929 and post World War II; Listed in the NRHP in 1989
C & O Railroad Bridge	Crosses Ohio River east of Brent Spence Bridge	The world's second longest continuous truss bridge constructed in 1929; Recommended as eligible for listing in the NRHP in 2008
Joseph Kuchle House	3 Kyles Lane	Residence constructed in 1902; Recommended as eligible for listing in the NRHP in 2008
Boehmer Decorating Center	533-535 Pike Street	Industrial building constructed during the 1870s; Recommended as eligible for listing in the NRHP in 2008
Residence	521 Western Avenue	Residence constructed in 1870; Recommended as eligible for listing in the NRHP in 2008
Glier's Goetta	533 Goetta Place	Utilitarian building constructed in 1903; Recommended as eligible for listing in the NRHP in 2008

**Table 10. Section 4(f) Resources in Kentucky**

<b>Name</b>	<b>Address</b>	<b>Description</b>
Kennedy-Rivard House	50 Rivard Drive	I-House residence constructed in 1850; Listed as a Kentucky Landmark in 1995; Recommended as eligible for listing in the NRHP in 2009
Residence	504 West 12 <sup>th</sup> Street	Italianate residence constructed in 1885; Recommended as eligible for listing in the NRHP in 2009
Residence	514 West 12 <sup>th</sup> Street	Italianate residence constructed in 1880; Recommended as eligible for listing in the NRHP in 2009
Residence	516 West 12 <sup>th</sup> Street	Italianate residence constructed in 1885; Recommended as eligible for listing in the NRHP in 2009
Residence	881 Highway Avenue	Gabled ell residence constructed in 1870; Recommended as eligible for listing in the NRHP in 2009
Residence	632 Western Avenue	Craftsman bungalow residence constructed in 1920; Recommended as eligible for listing in the NRHP in 2009

**Table 11. Section 4(f) Resources in Ohio**

<b>Name</b>	<b>Address</b>	<b>Description</b>
Park at Derrick Turnbow and Linn Street	1525 Linn Street	Behind apartment buildings and a strip shopping center - Owned by the City of Cincinnati
Dyer Park	Baymiller Street and Bank Street	Ball Field, Pool and Playground - Owned by the City of Cincinnati - Operated by Cincinnati Recreation Commission
Lincoln Community Center	1027 Linn Street	Pool, playground, tennis court, basketball courts - Owned by the City of Cincinnati - Operated by Cincinnati Recreation Commission
Queensgate Playground and Ballfields	707 West Court Street	Playground and ballfields - Owned by the City of Cincinnati - Operated by Cincinnati Recreation Commission
Chem-Pak, Inc.	2261 Spring Grove Avenue	Constructed in 1890; determined eligible for listing in the NRHP in 2007
Our Lady of Mercy	1409 Western Avenue	Constructed in 1897; Listed in the NRHP in 1980
Longworth Hall - Baltimore Ohio RR - Freight	700 Pete Rose Way	1904/Rehabilitated; Listed in the NRHP in 1986

**Table 11. Section 4(f) Resources in Ohio**

Name	Address	Description
Union Terminal Lincoln Park	1301 Western Avenue	Constructed in 1933; Listed in the NRHP in 1972; National Historic Landmark 1977
Harriet Beecher Stowe Elementary School (Fox 19 TV Station)	635 West 7 <sup>th</sup> Street	Constructed in 1923; Recommended as eligible for listing in the NRHP in 2008
West Fourth Street Historic District and Amendment	Central Business District	Constructed between 1870-1927; Listed in the NRHP in 1976, Amended 1979
Dayton Street Historic District	West End	Constructed between 1860-1880; Listed in the NRHP in 1973
John Mueller House	724 Mehring Way	Constructed in 1877; Recommended as eligible for listing in the NRHP in 2007
West Virginia Coal and Coke Building	725 Front Street	Building used for coal operations; Potentially eligible for the NRHP under Criterion A.

### **3.7 Section 6(f) Resources**

Section 6(f) of the Land and Water Conservation Fund Act (LWCFA) of 1965 (16 U.S.C. 4601-4) established a funding source for both federal acquisition of park and recreation lands and matching grants to state and local governments for recreation planning, acquisition and development. Section 6(f) prohibits the conversion of property acquired or developed with LWCFA grants to a non recreational purpose without the approval of the National Park Service. Section 6(f) applies only to parks that have received LWCFA funding.

There are only two Section 6(f) resources in the study area, Devou and Goebel parks in Covington (Exhibits 11A, 11B, and 17A). Devou Park received a LWCFA development grant of \$23,000 in 1993, and Goebel Park was awarded an acquisition and development grant of \$687,545 in 1978. According to the City of Covington Neighborhoods, Parks, and Recreation Department, the Goebel Park boundary encompasses Kenney Shields Park and the Neighborhood Pool. None of the parks in Cincinnati have received LWCFA grants.

### **3.8 Hazardous Materials**

An inventory of hazardous materials sites in the study area was completed in 2007 and documented in the report, *Environmental Site Assessment Screening (April 2007)*.

A review of literature and secondary information sources resulted in the identification of 81 properties recommended for Phase I Environmental Site Assessment (ESA). Fifteen of the 81 properties are located in Kentucky and 66 are located in Ohio (Exhibit 18A – 18C). These properties include gas stations, auto repair and dealerships, convenience stores, junk yards, gas and electric facilities, and industrial businesses. Contaminants associated with such properties include petroleum hydrocarbons (i.e. gasoline and diesel

fuel), Volatile Organic Compounds (VOCs), Semivolatile Organic Compounds (SVOCs), heavy metals, and Polychlorinated Biphenyls (PCBs).

In Kentucky there is a large area of surface lead soil contamination associated with the last painting of the Brent Spence Bridge. While some of this area has been remediated, other areas are expected to require some type of remediation. In Ohio, there is a Comprehensive Environmental Response, Compensation, and Liability Information System (CERCLIS) site in the Queensgate area. According to the CERCLIS database, this site is owned by CSX Transportation and contained abandoned batteries, drums containing cadmium wastes and caustics. This site was cleaned up in 2004 and is currently a vacant parcel covered with herbaceous vegetation.

### **3.9 Noise**

The study area is both urban and suburban in nature. The primary land uses within the study area are commercial, industrial, residential, institutional, and existing roadway rights of way. The principal source of noise in the study area is motor vehicles traveling on the interstate and local roadway networks. Vehicle noise is a combination of the noises produced by the engine, exhaust, and tires.

Highway traffic noise is never constant. The noise level is always changing with the number, speed, and type of vehicles which produce noise as well as the driving habits of vehicle operators. Generally, the loudness of traffic noise is increased by heavier traffic volumes, higher speeds, and greater numbers of trucks.

Traffic noise levels are expressed in terms of an hourly equivalent continuous noise level, which is abbreviated as  $L_{eq}$  (1-hour) dBA. The one-hour equivalent noise level during the noisiest traffic hour, expressed as  $L_{eq}$  (1-hour dBA), is used by the Federal Highway Administration (FHWA) as the descriptor for assessing the effects of traffic noise.

A noise analysis was completed for the study area. The results are presented in the report, *Noise Screening Report* (February 2009). Ambient noise levels were recorded throughout the study area at 103 locations, 55 sites in Kentucky and 48 sites in Ohio (Exhibit 19A – 19B). Ambient noise is noise that results from natural and mechanical sources as well as human activity, and is considered to be usually present in a particular area. Noise levels were recorded during peak and off-peak hours under calm, cool, and mostly cloudy conditions during the week of October 10, 2006. Table 12 and Table 13. present the ambient noise levels in the study area.

To determine if highway noise levels are compatible with various land uses, FHWA has developed noise abatement criteria (NAC) and procedures to be used in the planning and design of highways. These abatement criteria and procedures are outlined in 23 (CFR), Part 772. Land uses in the study area fall into two NAC categories:

- Category B, which includes picnic areas, recreation areas, playgrounds, active sports areas, parks, residences, motels, hotels, schools, churches, libraries and hospitals.
- Category C, which includes developed lands (i.e. commercial, industrial and manufacturing), properties, or activities not included in categories A and B.

The NAC is 67 dBA for Category B and 72 dBA for Category C. Noise impacts occur when the predicted noise level at a receptor approaches or exceeds the FHWA NAC or when the difference between existing and future noise levels is considered a substantial increase. Both KYTC and ODOT consider a substantial increase to be a predicted noise level increase of 10 dBA or more above existing levels.

The ambient noise levels presented in Table 12. and Table 13. indicate that existing noise levels at the majority of sites in the study area approach or exceed the NAC criteria of 67 dBA for Category B and 72 dBA for Category C land uses.

**Table 12. Ambient Noise Levels in Kentucky**

Site Number	Land Use	Field Measured Noise Level (L <sub>eq</sub> )	Comments
KY-1	Park	66	Ambient Reading
KY-2	Church	69.3	Ambient Reading
KY-3	Residential	73.2	Ambient Reading
KY-4	Commercial	68.2	Ambient Reading
KY-5	Park	65.5	Ambient Reading
KY-6	Residential	70.6	Ambient Reading
KY-7	Residential	67.9	Ambient Reading
KY-8	Residential	69.7	Ambient Reading
KY-9	Residential	73.2	Ambient Reading
KY-10	Hospital	58.1	Ambient Reading
KY-11	Residential	65.7	Ambient Reading
KY-12	Residential	59.7	Ambient Reading
KY-13	Residential	69.7	Ambient Reading
KY-14	Cemetery	68.8	Ambient Reading
KY-15	Commercial	69.4	Modeled
KY-16	Commercial	68.8	Modeled
KY-17	Commercial	70.4	Modeled
KY-18	Commercial	76.3	Modeled
KY-19	Residential	67.7	Modeled
KY-20	Residential	72.6	Modeled
KY-21	Residential	68.3	Modeled
KY-22	Residential	77.0	Modeled
KY-23	Residential	68.7	Modeled
KY-24	School	76.7	Modeled
KY-25	Residential	71.5	Modeled
KY-26	Residential	70.2	Modeled
KY-27	Residential	77.0	Modeled
KY-28	Residential	79.3	Modeled
KY-29	Residential	65.9	Modeled
KY-30	Residential	65.6	Modeled
KY-31	Residential	81.6	Modeled
KY-32	Residential	67.2	Modeled
KY-33	Residential	75.7	Modeled
KY-34	Residential	75.3	Modeled
KY-35	Residential	74.3	Modeled
KY-36	Residential	68.0	Modeled

Table 12. Ambient Noise Levels in Kentucky

Site Number	Land Use	Field Measured Noise Level (L <sub>eq</sub> )	Comments
KY-37	Residential	76.7	Modeled
KY-38	School	68.4	Modeled
KY-39	Residential	75.9	Modeled
KY-40	Residential	76.1	Modeled
KY-41	Residential	73.2	Modeled
KY-42	Residential	71.7	Modeled
KY-43	Residential	77.3	Modeled
KY-44	Residential	70.9	Modeled
KY-45	Residential	78.6	Modeled
KY-46	Park	74.5	Modeled
KY-47	Residential	77.4	Modeled
KY-48	Residential	76.0	Modeled
KY-49	Residential	71.4	Modeled
KY-50	Residential	72.0	Modeled
KY-51	Commercial	75.7	Modeled
KY-52	Commercial	69.3	Modeled
KY-53	Residential	68.8	Modeled
KY-55	Hotel	66.6	Modeled
KY-56	Hotel	68.4	Modeled

Table 13. Ambient Noise Levels in Ohio

Site Number	Land Use	Field Measured Noise Level (L <sub>eq</sub> )	Comments
OH-1	Residential	69.2	Ambient Reading
OH-2	Residential	70.1	Ambient Reading
OH-3	Commercial	72.5	Ambient Reading
OH-4	Residential	68.0	Ambient Reading
OH-5	Church	72.3	Ambient Reading
OH-6	Commercial	76.0	Ambient Reading
OH-7	Daycare	68.8	Ambient Reading
OH-8	School	71.3	Ambient Reading
OH-9	Residential	74.0	Ambient Reading
OH-10	Residential	72.8	Ambient Reading
OH-11	Commercial	74.6	Ambient Reading
OH-12	Commercial	70.5	Ambient Reading
OH-13	Commercial	70.6	Ambient Reading
OH-14	Commercial	72.0	Ambient Reading
OH-16	Commercial	73.8	Modeled
OH-17	Commercial	65.6	Modeled
OH-18	Residential	75.8	Modeled
OH-20	Residential	69.0	Modeled
OH-22	Residential	71.7	Modeled
OH-25	Commercial	69.2	Modeled

**Table 13. Ambient Noise Levels in Ohio**

Site Number	Land Use	Field Measured Noise Level (Leq)	Comments
OH-26	Residential	67.4	Modeled
OH-27	Commercial	71.5	Modeled
OH-29	Residential	69.9	Modeled
OH-31	Commercial	76.2	Modeled
OH-32	Residential	72.7	Modeled
OH-33	Residential	75.4	Modeled
OH-34	Commercial	71.2	Modeled
OH-35	Residential	69.1	Modeled
OH-36	Commercial	74.9	Modeled
OH-37	Commercial	74.1	Modeled
OH-38	Residential	68.4	Modeled
OH-39	Commercial	74.9	Modeled
OH-40	Residential	73.8	Modeled
OH-41	Park	77.6	Modeled
OH-42	Commercial	70.0	Modeled
OH-43	Residential	69.3	Modeled
OH-44	Residential	75.8	Modeled
OH-45	Commercial	73.5	Modeled
OH-46	Residential	72.7	Modeled
OH-47	Commercial	67.2	Modeled
OH-48	Commercial	66.4	Modeled
OH-49	Commercial	68.3	Modeled
OH-50	Commercial	65.6	Modeled
OH-51	Commercial	74.7	Modeled
OH-52	Commercial	70.6	Modeled
OH-53	Commercial	65.7	Modeled
OH-54	Commercial	71.8	Modeled
OH-55	Commercial	75.4	Modeled

### **3.10 Utilities**

A wide range of underground and aboveground utilities are present within the study area in both Kentucky and Ohio (Exhibit 20A – 20G). These utilities include electric transmission lines, high pressure gas mains, electric substations, sanitary and combined sewer lines, water mains, fiber optic lines, and transmission towers. A total of 13 public utility companies have been identified as having facilities within the study area:

- AT&T Fiber Optics
- Cincinnati Bell (telephone)
- Cincinnati Water Works
- Duke Energy (gas and electric)
- Insight Communications
- Level 3 Communications, LLC
- Metropolitan Sewer District (Greater Cincinnati)
- MCI/Verizon Fiber Optic
- Northern Kentucky Water District
- Sanitation District Number 1 (Northern Kentucky)

- Sprint Fiber Optic
- Time Warner Cable
- Qwest National Network Services

A utility coordination meeting was held on March 16, 2006 to provide preliminary project information and to begin coordination between the Project Team and utility providers. From the meeting, a utility coordination team was formed. This team will work together to ensure that no loss of service occurs during construction or operation of the project. Utility correspondence and documentation is provided in Appendix G.

Duke Energy conducted an assessment of the impacts that the conceptual alternatives would have on their utilities in 2008. An overview of the required work and costs associated with relocation of the utilities was also prepared for the conceptual alternatives. Documentation provided by Duke Energy is provided in Appendix G.

## **3.11 Transportation**

### **3.11.1 Pedestrian and Bicycle Facilities**

Within Kentucky, a pedestrian and bicycle trail is located in Goebel Park. Pedestrian facilities within the study area are in the form of sidewalks on city streets and overpasses of the I-75 and I-71 corridor. There are currently no designated bike paths in the study area in Ohio. A bicycle path in the area on the Ohio side is planned along the Riverfront following Mehring Way as part of the Cincinnati Riverfront Park Plan.

### **3.11.2 Transit**

Southwest Ohio Regional Transit Authority (SORTA) and Transit Authority of Northern Kentucky (TANK) provide public bus transportation in the study area. SORTA bus stops for buses 10, 27, 32, 33, 50, and 85 are located within the study area. TANK bus stops within the study area are located at KY 3<sup>rd</sup> Street, KY 5<sup>th</sup> Street, and Crescent Avenue. Both SORTA and TANK support accommodation of a Bus-On-Shoulder program along the project corridor. SORTA currently does not have plans to expand their Bus-On-Shoulder program on I-75 but could do so in the future.

Planning for regional light rail was developed as part of the *North-South Transportation Initiative* (2004). The planned regional light rail line would follow the I-75 corridor and provide service to Cincinnati and northern Kentucky. It is anticipated that light rail would use the Clay Wade Bailey Bridge to cross the Ohio River and not the Brent Spence Bridge. As shown in cross section plans in Appendix B, the planned regional light rail line would be accommodated south of the Ohio River (south of KY 12<sup>th</sup> Street) and north of Western Hills Viaduct.

## **4.0 EVALUATION OF THE ALTERNATIVES**

Studies completed for the No Build Alternative and conceptual alternatives (B, C, D, E, and G) included environmental studies, traffic analyses, travel lane evaluations, refinement of horizontal and vertical alignments, cost estimates, utilities coordination, and stakeholder coordination. The following sections present the results of these studies. Impacts were determined using the construction limits of each alternative. A



summary matrix of the impacts, design features, and costs of the conceptual alternatives is provided in Section 7.0.

## **4.1 Traffic and Capacity Analyses**

Travel demand model and recent traffic count data were utilized to develop traffic projections for the No Build and conceptual alternatives in the 2035 design year. Certified traffic was used in the traffic analyses.

### **4.1.1 Traffic Volumes**

Traffic counts were performed on an average weekday within the Brent Spence Bridge study area in September, October, and November of 2005 in order to obtain existing weekday traffic volumes. Additional traffic counts were conducted in January 2008 to collect additional traffic data at the Dixie Highway Interchange, along McMillan Avenue, and on I-71 near the I-471 Interchange area. Traffic volumes for at-grade intersections were collected using turning movement counts, while ramp and mainline volumes on I-71, I-75, and US 50 were collected using portable machine counters. The AM and PM peak hours were identified from the traffic counts and were used in the 2005 analyses for the study area. The AM and PM peak hours are 7:30 to 8:30 AM and 4:30 to 5:30 PM.

Design year (2035) traffic volumes were determined using the Ohio Kentucky Indiana Regional Council of Governments (OKI) regional travel demand model. In order to coordinate the traffic projections within the I-75 corridor and the region, traffic projections for all three adjoining I-75 projects (HAM-71/75-0.00/0.22 Brent Spence Bridge, HAM-75-2.30 Mill Creek Expressway, and HAM-75-10.10 Thru the Valley) were incorporated into the OKI regional travel demand model. The 2005 volumes were used to project the peak hour volumes for design year 2035. In addition to the No Build condition, the OKI demand model was manipulated to compute 2035 design hour traffic volumes for the five conceptual alternatives. The demand model was re-run for each of the conceptual alternatives because differences in freeway access points could affect local street and freeway traffic patterns. Truck percentages for the study area were calculated based on existing traffic counts and growth rates generated from the travel demand model.

### **4.1.2 Capacity Analyses**

The capacity analyses were performed using *Highway Capacity Software (HCS+)* version 5.3. Capacity analyses are performed to estimate the maximum amount of traffic that can be accommodated by a roadway facility while maintaining prescribed operational qualities. This is accomplished using the level of service (LOS) concept. LOS is an assessment of roadway and intersection performance, expressed LOS A to F. LOS A represents free-flow conditions where vehicles are almost completely unimpeded in their ability to maneuver within the traffic stream. LOS E is defined as using all available capacity, where vehicles are closely spaced within the traffic stream and there are virtually no usable gaps to maneuver. LOS F exceeds the roadway's capacity and there is a breakdown of vehicle flow. Typically, in urban areas, a roadway component is deemed adequate if the corresponding LOS is D or better, while LOS E and F indicate near failure or failure, respectively.

Freeways consist of three parts: basic freeway segments, ramp (exit and entrance) segments, and weaving sections. The basic freeway segments are those sections of the

freeway that are free from merging, diverging, and weaving. Freeway segments were analyzed using the HCS Freeway module and included information pertaining to total traffic volume, number of freeway lanes, design speed of the facility, and truck percentages as part of the analysis. Weaving volumes were allocated proportionately by the upstream and downstream ramp and mainline volumes. A volume/capacity > 1.00 denotes LOS F; higher values indicate how much over capacity the demand volume is for freeway segments having LOS F. The capacity of a particular freeway segment is directly related to the number of lanes available, the truck percentage on that segment, and the design speed. All conceptual alternatives were assumed to have a mainline design speed of 60 miles per hour (mph).

Ramp merge and diverge areas were analyzed using one of two methodologies. If the ramp did not create an add- or drop-lane condition, the HCS Ramps module provided estimated densities for the merge or diverge area. This analysis incorporated information pertaining to total freeway volume upstream of the merge/diverge area, ramp volume, number of freeway lanes, number of ramp lanes, design speeds of both the freeway and ramp, and truck percentages for both the freeway and ramp. The densities correlate with levels of service for the merge/diverge area.

The second methodology for ramp areas is used when there is an add- or drop-lane condition in the merge or diverge area. In this case, these areas are treated as “major merge” or “major diverge” areas and each freeway segment of the merge or diverge area has its own density calculation. The HCS Freeway module can only analyze segments with two or more lanes. Therefore, single-lane ramps were analyzed as two-lane segments with double their actual volumes.

The study area contains both signalized and unsignalized intersections on local streets. Intersections that had projected turning movements were analyzed with either the HCS Signals or Unsignalized module, depending on the type of traffic control currently at the intersection. Operational information, including signal cycle length, was obtained from field observation and intersection inventories. For intersections, level of service is defined by the average amount of control delay experienced by vehicles. At traffic signals, delay is calculated for each approach as well as for the overall intersection.

#### **4.1.3 Development of Certified Traffic**

In the development of certified traffic, the existing four hour turning movement counts were factored to average daily traffic (ADT) volumes using the Ohio Department of Transportation’s (ODOT) hourly distribution and seasonal adjustment factors by functional class. The 72-hour and 48-hour ramp counts were converted to ADTs by applying the seasonal adjustment factor by functional class. The calculated ADT volumes were compared to historical count information and ODOT ramp counts. The existing traffic counts were then smoothed along the mainline and between intersections as appropriate for the AM, PM, and calculated ADT volumes. Finally, the AM and PM volumes were factored to the design hour by applying a factor of 1.056, as was done for the HAM-75-2.30 PID 76257 (Mill Creek Expressway) project, which is located at the northern limits of this project. This process for developing certified traffic was agreed to by the Kentucky Transportation Cabinet (KYTC).

The OKI regional travel demand model was used to develop traffic assignments for the 2035 design year. Using the methods described in the National Cooperative Highway

Research Program (NCHRP) 255 report, 24-hour model assignments were post-processed by comparing the ADT count data to the base year (2005) model assignment and applying the same over/under estimation to the future year (2035) model assignment. A hybrid mix of the ratio and delta methods were applied to each link. Finally, the 2035 ADT was calculated by applying a straight line extrapolation between the 2005 count and the post-processed 2035 ADT.

A growth factor was calculated for each link by dividing the 2035 ADT by the 2005 traffic count. This factor was then applied to the AM and PM peak hour count data to get 2035 AM and PM peak hour data.

Turning movement forecasts for the 2035 AM, PM, and ADT were made using the NCHRP 255 iterative proportional method. Interchanges were treated as single point intersections where possible to determine the mainline, cross street, and ramp volumes at one time.

Finally, all 2035 traffic volumes on the mainline and between intersections were smoothed as appropriate for the AM, PM, and ADT periods.

#### **4.1.4 Future Traffic Demand (2035)**

For I-75 mainline segments north of the Ohio River, future traffic demand (2035) results show similar future volumes for the conceptual alternatives. In the northbound direction future volumes will range from 5,640 to 8,910 depending on alternative and segment. In the southbound direction future volumes will range from 2,730 to 9,820 depending on alternative and segment.

For I-71/I-75 mainline segments between the Dixie Highway Interchange to the Ohio River, future traffic demand (2035) results show similar future volumes for the conceptual alternatives. In the northbound direction future volumes will range from 2,450 to 9,280 depending on alternative and segment. In the southbound direction future volumes will range from 5,900 to 10,390 depending on alternative and segment.

For I-71 mainline segments north of the Ohio River, future traffic demand (2035) results show similar future volumes for the conceptual alternatives. In the northbound direction future volumes will range from 2,240 to 7,530 depending on alternative and segment. In the southbound direction future volumes will range from 2,310 to 6,690 depending on alternative and segment.

#### **4.1.5 Mainline Segment Analysis**

Basic freeway segments include the portions of freeway where flow is not influenced by the diverging, merging, or weaving associated with ramp/freeway connections. The primary factors that affect operations on basic freeway segments include: lane widths, lateral clearance, the number of lanes, interchange density, heavy vehicles, grades, and driver familiarity. Results of the 2035 future condition analyses performed on the mainline segments of I-71, I-75, and selected roadway connections are presented in Table 14 and Table 15. Table 14 presents a summary of the total number of freeway segments for I-75, I-71, US 50, and the I-71/I-75 connector, and the projected 2035 levels of service. Table 15 presents a list of freeway segments with a LOS E or F in 2035, and includes the locations and number of segments.

**ODOT PID 75119**  
**KYTC Item No. 6-17**  
**Conceptual Alternatives Study**

On I-75 northbound, all alternatives would have a LOS F from the southern limits of the project through the Dixie Highway Interchange in 2035. Alternative E is the only alternative that does not have any segments with LOS E or F north of Dixie Highway. Alternatives B, C, D, and G have one segment with LOS F north of the Dixie Highway Interchange. Alternative D also has one segment that is near-failure. On I-75 southbound, none of the segments fail north of the Kyles Lane diverge for any of the conceptual alternatives. Alternative E has four segments that would result in LOS E, Alternative D has six segments and the remaining alternatives have seven segments. The locations and number of segments that would be near failure for each conceptual alternative are listed in Table 15.

On I-71 northbound, all segments fail or are near failure in the AM peak hour. Alternative G is the only alternative that does not have connections from I-75/US 50 that fail or are near failure in the AM peak hour. On I-71 southbound, the segment north of the I-471 diverge and the segment between OH 3<sup>rd</sup> Street diverge to US 50 merge, fail in the PM peak hour for all conceptual alternatives.

On US 50, there are no segments that are below LOS D for any of the conceptual alternatives.

The freeway segment analysis for Alternatives B, C, D, E, and G, determined that Alternative E operates best when reviewing operations at freeway segments only. Alternatives B, C, D, and G all operate at nearly the same efficiency when considering the level of service at Basic Freeway segments. All of the conceptual alternatives would operate better than the No Build option in 2035. Additional information and data regarding the level of service for the basic freeway segments can be found in Appendix A.

**Table 14. Summary of LOS for Freeway Segments of the Conceptual Alternatives**

Freeway	Direction	LOS	2035 NO BUILD		Number of Freeway Segments									
					Alt B		Alt C		Alt D		Alt E		Alt G	
			A	P	A	P	A	P	A	P	A	P	A	P
I-75	Northbound		M	M	M	M	M	M	M	M	M	M	M	M
		A												
		B			1		1				2		1	
		C	7		4		4		5		7	1	4	1
		D	4	6	4	8	3	7	3	6	3	11	3	6
		E	2	4						1				
		F	5	8	2	3	2	3	2	3	2	2	2	3
	Southbound	A												
		B	1									1		
		C	6	2	2	1	2	1	2	2	5	6	2	1
		D	5	7	4	4	4	4	5	3	6	2	3	3
		E	3	5	4	3	4	3	3	3	2	2	4	3
		F	6	7		2		2		2		2		2

Table 14. Summary of LOS for Freeway Segments of the Conceptual Alternatives

Freeway	Direction	LOS	2035 NO BUILD		Number of Freeway Segments										
					Alt B	Alt C	Alt D	Alt E	Alt G						
I-71	Northbound	A													
		B				1		1		1		1		1	
		C	1	6		4		5		5		5		6	
		D		1		1		1		1		1	2	1	
		E	3		3		4		4		4		4		
		F	3		3		3		3		3		2		
	Southbound	A													
		B									2				
		C	2		1		2		2		2		2		
		D	3	3	4	3	4	3	4	3	4	5	3	2	
		E	1					1		1		1		1	
		F		3		2		2		2		2	1	3	
US 50	Eastbound	A		2		2		3		2		2		2	
		B	1	2		3	2	2	1	3	2	2	1	2	
		C	2	1	3		2		3		2		2		
		D	2		2		1		1				1		
		E													
		F													
	Westbound	A	4	1	4	1	4	1	3	1	3		4	1	
		B	1	2	1	2	1	2	2	1	1	3		2	
		C		2		2		1		3		1		1	
		D						1							
		E													
		F													
I-71/I-75 Connector	Northbound	A	1		1	4	2	3	2	4	7	4	1	1	
		B	1	1	5	3	4	3	6	4		3	3	8	
		C	1	1	3	3	2	3	5	4	4	3	1	3	
		D	1	3	4	4	2	2	1	3	1	3	7	2	
		E	1		1		1		1		1				
		F											2		
	Southbound	A			4	1	6	2	5	2	3	1	5	1	
		B			3	3	3	4	2	1	1	5	4	5	
		C		1	4	5	4	5	6	7	2	4	4	6	
		D	1	3	4	2	5	1	3	1	4		4	2	
		E	2		1	1		2		1				1	
		F	1			4		4		4				2	

Table 15. Comparison of Freeway Segments by Conceptual Alternative

Freeway	Direction	Alternative	Freeway Segments At or Near Failure (LOS E or LOS F)
I-75	Northbound	No Build	14 of 18 segments fail or are near failure from south end of study corridor to KY W 4 <sup>th</sup> Street, and from W 9 <sup>th</sup> merge to north end of the study area in one or both peak hours.
		B	(3 of 11 segments fail in one or both peak hours); south of Dixie Highway to Dixie Highway merge fail in both AM and PM peak hour. I-71 NB diverge to I-71 SB/local CD merge fails during PM peak hour.
		C	(3 of 10 segments fail in one or both peak hours); south of Dixie Highway to Dixie Highway merge fail in both AM and PM peak hour. I-71 NB Diverge to I-71 SB/local CD merge fails during PM.
		D	(4 of 10 segments fail or are at near failure in one or both peak hours); south of Dixie Highway to Dixie Highway merge fail in both AM and PM peak hour. I-71 diverge to local NB merge fails during PM peak hour. Local NB merge to Central Parkway diverge at near failure during PM.
		E	(2 of 14 segments fail in both peak hours); south of Dixie Highway to Dixie Highway merge fails in both AM and PM peak hour.
		G	(3 of 10 segments fail in one or both peak hours); south of Dixie Highway to Dixie Highway merge fails in both AM and PM peak hour. I-71 diverge to local NB merge fails during PM.
	Southbound	No Build	(20 of 21 segments fail or are at near failure in one or both peak hours); Most fail or are near failure on entire length of study corridor in one or both peak hours except I-71 NB diverge to OH W 9 <sup>th</sup> Street merge.
		B	(8 of 10 segments fail or are at near failure in one or both peak hours); Western Hills Viaduct diverge to north of Western Hills Viaduct diverge at near failure in the AM peak hour. I-71 NB/local CD diverge to I-71 SB merge at near failure during AM peak hour. Local CD merge to South of Dixie merge fails or is at near failure in one or both peak hours.
		C	(8 of 10 segments fail or at near failure in one or both peak hours); Western Hills Viaduct diverge to north of Western Hills Viaduct diverge at near failure in the AM peak hour. I-71 NB/local CD diverge to I-71 SB merge at near failure during AM peak hour. Local CD merge to South of Dixie merge fails or is at near failure in one or both peak hours.
		D	(7 of 10 segments fail or are at near failure in one or both peak hours); North of Western Hills Viaduct diverge to Western Hills Viaduct diverge and I-71 NB/local diverge to I-71 SB merge at near failure in AM peak hour. Local merge to south of Dixie merge fails or is at near failure in one or both peak hours.
E		(5 of 13 segments fail or are at near failure in one or both peak hours); North of Western Hills Viaduct diverge to Western Hills Viaduct diverge at near failure during AM peak hour. W 12 <sup>th</sup> Street to south of Dixie merge fails or at near failure in one or both peak hours.	

**Table 15. Comparison of Freeway Segments by Conceptual Alternative**

Freeway	Direction	Alternative	Freeway Segments At or Near Failure (LOS E or LOS F)
		G	(8 of 9 segments fail or are at near failure in one or both peak hours); Most fail or are near-failures throughout the corridor in either AM or PM peak hour except I-71 SB merge to local CD merge.
I-71	Northbound	No Build	All 6 segments but one (W 2 <sup>nd</sup> merge to W 5 <sup>th</sup> merge) fail or are near failure in the AM peak hour.
		B	All 6 segments fail or are near failure in AM peak hour.
		C	All 7 segments fail or are near failure in AM peak hour.
		D	All 7 segments fail or are near failure in AM peak hour.
		E	All 7 segments fail or are near failure in AM peak hour.
		G	(6 of 8 segments fail or are at near failure during the AM peak hour); W 9 <sup>th</sup> /local merge to US 50/I-75 SB merge. NB local ramps merge to Gilbert merge.
	Southbound	No Build	(4 of 5 segments fail during the PM peak hour); north of I-471 diverge to US 50 merge. W 3 <sup>rd</sup> Street merge.
		B	(2 of 5 segments fail in PM peak hour); north of I471 diverge. 3 <sup>rd</sup> Street diverge to US 50 merge.
		C	(3 of 6 segments fail or are at near failure in PM peak hour); North of I-471 diverge and 3 <sup>rd</sup> Street diverge to US 50 merge fail during the PM. I-75 NB/US 50 diverge to SB local diverge at near failure during PM.
		D	(3 of 6 segments fail or are at near failure in PM peak hour); north of I-471 diverge and 3 <sup>rd</sup> Street diverge to US 50 merge fail during the PM. I-75 NB/US 50 diverge to SB local diverge at near failure during PM.
		E	(3 of 6 segments fail or are at near failure in PM peak hour); North of I-471 diverge and 3 <sup>rd</sup> Street diverge to US 50 merge fail during the PM. I-75 NB/US 50 diverge to W 3 <sup>rd</sup> Street diverge at near failure during PM.
		G	(4 of 6 segments fail or are at near failure in one or both of the peak hours); north of I-471 diverge, 3 <sup>rd</sup> Street diverge to US 50 merge fails in PM peak hour. I-471 diverge to 3 <sup>rd</sup> Street diverge fails in both peak hours. I-75 NB diverge to SB local diverge at near failure during the PM peak hour.
US 50	Eastbound	No Build	All segments at or above a LOS D.
		B	All segments at or above a LOS D.
		C	All segments at or above a LOS D.
		D	All segments at or above a LOS D.
		E	All segments at or above a LOS C.
		G	All segments at or above a LOS D.

Table 15. Comparison of Freeway Segments by Conceptual Alternative

Freeway	Direction	Alternative	Freeway Segments At or Near Failure (LOS E or LOS F)
US 50	Westbound	No Build	All segments at or above LOS C.
		B	All segments at or above LOS C.
		C	All segments at or above LOS D.
		D	All segments at or above LOS C.
		E	All segments at or above LOS C.
		G	All segments at or above LOS C.
I-71/I-75 Connector	Northbound	No Build	(1 of 5 segments at near failure in AM peak hour); US 50 diverge to W 4 <sup>th</sup> Street merge.
		B	(1 of 14 segments at near failure in AM peak hour); US 50 diverge to NB Connector merge.
		C	(1 of 11 segments at near failure in AM peak hour); US 50 diverge to connector merge.
		D	(1 of 15 segments at near failure in AM peak hour); US 50 diverge to NB connector merge.
		E	(1 of 13 segments at near failure in AM peak hour); US 50/I-75 SB split to I-75 NB merge.
		G	(2 of 14 segments fail in the AM peak hour); W 5 <sup>th</sup> diverge to Pike Street merge and I-75 NB connector split to the I-75 NB connector merge.
	Southbound	No Build	(3 of 4 segments fail or are at near failure in the AM peak hour); I-75 SB diverge to W 5 <sup>th</sup> Street diverge. W 2 <sup>nd</sup> diverge to US 50 merge. US 50 merge to I-75 NB merge.
		B	(6 of 16 segments fail or are at near failure in one or both peak hours); Western Hills Viaduct merge to local SB ramp diverge fails in the AM. SB connector diverge to Freeman diverge fails during the PM. In the PM peak hour, all segments on the one-lane local CD roadway south of the W 9 <sup>th</sup> Street merge fail.
		C	(2 of 18 segments are at near failure in the PM peak hour); local CD split to Freeman diverge. W 3 <sup>rd</sup> Street merge to local CD merge.
		D	(5 of 16 segments fail or are at near failure during the PM peak hour); Segments from W 9 <sup>th</sup> merge to I-75 SB merge. W 3 <sup>rd</sup> Street merge to I-71/I-75 SB connector merge is at near failure during the PM peak hour.
		E	All segments at or above LOS D.
		G	(3 of 17 segments fail or are at near failure during the PM peak hour); The segments between the I-71 SB merge and the I-75 SB merge.



#### 4.1.6 Ramp-Freeway Junctions

The operations analysis for ramp junctions with the freeway mainline typically involves the effects of vehicles either merging onto or diverging from the mainline. The analysis considers an influence area of 1,500 feet (downstream from ramp if merging and upstream from ramp if diverging). It should be noted that while the HCS methodology defines the influence area of merging or diverging traffic to be within 1,500 feet, the effects can extend outside of this area. When comparing the conceptual alternatives, there are more ramp junctions throughout the I-71, I-75, and I-71/I-75 connector that fail or are at near-failure (LOS E and F) for Alternatives B, C, D, and G than for Alternative E. The number of ramp junctions varies for each alternative with the No Build Alternative having the least with 50 ramp junctions. Alternative B has 60 total ramp junctions, Alternative C has 59, Alternative D has 63, Alternative E has 64, and Alternative G has the most ramp junctions with 66. On US 50, all alternatives have ramp junctions at LOS D or better with Alternative G having one near-failure occurrence at the West OH 5<sup>th</sup> Street diverge. The analysis of ramp junctions identifies Alternative E as operating at a higher level of service than all of the other alternatives. However, all of the alternatives studied operated better than the no build option in 2035. Table 16 lists the specific ramp junctions that would be at failure or near-failure in 2035. Additional information and data regarding the level of service at ramp junctions can be found in Appendix A.

**Table 16. Comparison of Ramp Junctions by Conceptual Alternative**

Freeway	Direction	Alternative	Ramp Junctions At or Near Failure (LOS E or LOS F)
I-75	Northbound	No Build	(13 of 16 ramp junctions fail or are at near failure in one or both peak hours); I-75 SB merge, W 9 <sup>th</sup> Street merge, and Western Hills Viaduct/Bank ramps converge do not fail.
		B	(4 of 13 junctions fail in one or both peak hours); Dixie Highway diverge, Dixie Highway merge, I-71 NB/I-75 NB split, and I-71 SB/local CD merge.
		C	(5 of 11 junctions fail or are at near failure in one or both peak hours); Dixie Highway diverge, Dixie Highway merge, I-71 NB/I-75 NB split, I-71 SB/local merge, and Western Hills Viaduct diverge.
		D	(5 of 12 junctions fail or are at near failure in one or both peak hours); Dixie Highway diverge, Dixie Highway merge, I-71 NB/I-75 NB split, local merge, and Central Parkway/Western Hills Viaduct diverge.
		E	(4 of 16 junctions fail or are at near failure in one or both peak hours); Dixie Highway diverge, Dixie Highway merge, I-71 NB/I-75 NB split, and I-71 SB merge.
		G	(4 of 11 junctions fail in one or both peak hours); Dixie Highway diverge, Dixie Highway merge, I-71 NB/I-75 NB split, and I-71 NB/local merge.
	Southbound	No Build	All ramps but one (12 of 13 junctions) fail in one or both peak hours. W 9 <sup>th</sup> Street merge does not fail.
		B	Of 12 ramp junctions on I-75, 8 fail or are near failure in one peak hour except; Findlay diverge, Kyles/Dixie merge, Kyles CD/Dixie exit split, and Dixie merge do not fail.

Table 16. Comparison of Ramp Junctions by Conceptual Alternative

Freeway	Direction	Alternative	Ramp Junctions At or Near Failure (LOS E or LOS F)
I-75	Southbound	C	Of 12 ramp junctions on I-75, 8 fail or are near failure in one peak hour except; Findlay diverge, Kyles/Dixie merge, Kyles CD/Dixie exit split, and Dixie merge do not fail.
		D	Of 12 ramp junctions on I-75, 8 fail or are near failure in one peak hour except; Findlay diverge, Kyles/Dixie merge, Kyles CD/Dixie exit split, and Dixie merge do not fail.
		E	Of 15 ramp junctions on I-75, 3 fail or are near failure in the PM peak hour; Kyles Lane Diverge and Kyles CD Merge fail in the PM. Kyles/Dixie Split at near failure in the PM.
		G	Of 11 ramp junctions on I-75, 8 fail or are near failure in one peak hour except; Kyles/Dixie merge, Kyles CD/Dixie exit split, and Dixie merge do not fail.
I-71	Northbound	No Build	5 of the 6 ramp junctions fail or are at near-failure in the AM peak hour; W 5 <sup>th</sup> Street merge does not fail.
		B	4 of the 5 ramp junctions fail in the AM peak hour; W 5 <sup>th</sup> Street merge does not fail.
		C	5 of the 6 ramp junctions fail in the AM peak hour; W 5 <sup>th</sup> Street merge does not fail
		D	5 of the 6 ramp junctions fail in the AM peak hour; W 5 <sup>th</sup> Street merge does not fail
		E	5 of the 6 ramp junctions fail in the AM peak hour; W 5 <sup>th</sup> Street merge does not fail
		G	5 of the 7 ramp junctions fail or are near failure in the AM peak hour; W 4 <sup>th</sup> /local merge and W 5 <sup>th</sup> Street merge does not fail.
	Southbound	No Build	4 of the 5 ramp junctions fail in the PM peak hour. I-75 NB diverge does not fail.
		B	3 of the 4 ramp junctions fail in the PM peak hour. US 50 WB/I-75 NB diverge does not fail.
		C	All ramps fail or are near failure in the PM peak hour (5 of the 5 ramp junctions).
		D	All ramps fail or are near failure in the PM peak hour (5 of the 5 ramp junctions).
		E	6 of the 7 ramp junctions fail or are near failure in the PM peak hour. W 9 <sup>th</sup> diverge (KY) does not fail.
		G	3 of the 5 ramp junctions fail in the PM peak hour. The Local SB diverge and the I-75 NB diverge do not fail.
US 50	Eastbound	No Build	All ramp junctions at or above a LOS D (2 of the 2 ramp junctions).
		B	All ramp junctions at or above a LOS D (2 of the 2 ramp junctions).
		C	All ramp junctions at or above a LOS D (2 of the 2 ramp junctions).
		D	All ramp junctions at or above a LOS D (3 of the 3 ramp junctions).

**Table 16. Comparison of Ramp Junctions by Conceptual Alternative**

<b>Freeway</b>	<b>Direction</b>	<b>Alternative</b>	<b>Ramp Junctions At or Near Failure (LOS E or LOS F)</b>
<b>US 50</b>	<b>Eastbound</b>	E	All ramp junctions at or above a LOS C (1 of the 1 ramp junctions).
		G	The W 5 <sup>th</sup> diverge is near failure in the AM peak hour, other ramp junctions at or above LOS D (2 of the 2 ramp junctions).
	<b>Westbound</b>	No Build	All ramp junctions at or above a LOS B (2 of the 2 ramp junctions).
		B	All ramp junctions at or above a LOS B (2 of the 2 ramp junctions).
		C	All ramp junctions at or above a LOS B (2 of the 2 ramp junctions).
		D	All ramp junctions at or above a LOS B (2 of the 2 ramp junctions).
		E	All ramp junctions at or above a LOS C (3 of the 3 ramp junctions).
G	All ramp junctions at or above a LOS C (2 of the 2 ramp junctions).		
<b>I-71/I-75 Connector</b>	<b>Northbound</b>	No Build	All 3 ramp junctions fail or are at near failure in the AM peak hour.
		B	(4 of 10 junctions fail or are at near failure in one of the peak hours); W 9 <sup>th</sup> merge (KY), US 50/I-71 SB split, and I-71 SB merge are at near failure during the AM peak hour. W 4 <sup>th</sup> merge (OH) fails during the PM peak hour.
		C	(4 of 9 junctions are at near failure in one of the peak hours); W 9 <sup>th</sup> merge (KY), US 50/I-71 SB split, and I-71 SB merge are at near failure during the AM peak hour. W 4 <sup>th</sup> merge (OH) fails during the PM peak hour.
		D	(4 of 11 junctions fail or are at near failure in one of the peak hours); W 9 <sup>th</sup> merge (KY), I-71 SB/US 50/I-75 NB diverge, and local/I-71 SB merge are at near failure during the AM peak hour. W 3 <sup>rd</sup> /W 4 <sup>th</sup> / W 6 <sup>th</sup> Street merge fails during the PM peak hour.
		E	(2 of 9 junctions are at near failure in one of the peak hours); W 4 <sup>th</sup> merge (OH) at near failure during the PM peak hour. US 50/I-75 NB to US 50 merge is at near failure during the AM peak hour.
		G	(5 of 15 junctions fail or are at near failure in the AM peak hour); W. 5 <sup>th</sup> diverge, W 12 <sup>th</sup> /Pike merge, I-71 NB diverge, W 2 <sup>nd</sup> diverge, and local/I-71 SB merge.
	<b>Southbound</b>	No Build	All 3 ramp junctions fail or are at near failure in the AM peak hour.
		B	(7 of 12 ramp junctions fail or are near failure in one of the peak hours); W 7 <sup>th</sup> diverge is at near failure during the AM peak hour. Freeman diverge, W 9 <sup>th</sup> merge (OH), US 50 EB merge, I-71 SB/W 3 <sup>rd</sup> merge, I-71 SB merge, and W 9 <sup>th</sup> diverge (KY) fail or are at near failure during the PM peak hour.

**Table 16. Comparison of Ramp Junctions by Conceptual Alternative**

<b>Freeway</b>	<b>Direction</b>	<b>Alternative</b>	<b>Ramp Junctions At or Near Failure (LOS E or LOS F)</b>
	<b>Southbound</b>	C	(6 of 12 ramp junctions fail or are at near failure during the PM peak hours); Freeman diverge and W 3 <sup>rd</sup> merge are at near failure. W 9 <sup>th</sup> merge, US 50 merge, and W 9 <sup>th</sup> diverge fail.
		D	(5 of 12 ramp junctions fail or are at near failure during the PM peak hours); W 3 <sup>rd</sup> merge w/ I-71 SB merge is at near failure. W 9 <sup>th</sup> merge, US 50 merge, W 3 <sup>rd</sup> merge, and W 9 <sup>th</sup> diverge fail.
		E	(1 of 7 ramp junctions is at near failure during the AM peak hour); I-71 NB/US 50 EB ramps merge.
		G	(3 of 13 ramp junctions fail in the PM peak hour); W 3 <sup>rd</sup> merge, W 5 <sup>th</sup> merge (KY) and W 9 <sup>th</sup> /Pike diverge.

#### **4.1.7 Local Street At-Grade Intersections**

The analysis of local street at-grade intersections included a review of operations at both unsignalized and signalized intersections. All intersections were analyzed using HCS+. At urban intersections, the level of service at signalized and stop-controlled intersections is the critical measure of how a roadway is functioning. Intersection level of service provides a measure of the impact of traffic from cross streets, as well as turning traffic. Level of service ranges from A to F, with A being very good (short signal cycles, almost no waiting to go through a signalized intersection); and F representing very poor (very long wait or wait through multiple signal cycles) or failure (gridlock). Historically, LOS C has been considered good and acceptable for an urban area. More recently, with the tremendous growth in travel, LOS D has become acceptable because limited financial resources could preclude otherwise worthy projects if they were constructed to LOS C.

The information indicates a number of failures at both unsignalized and signalized intersections. In order to provide better levels of service, geometric improvements at many of those intersections will be necessary. Table 17 shows a comparison of the 2035 level of service for unsignalized and signalized intersections for each conceptual alternative. Detailed information regarding the level of service at all intersections can be found in Appendix A.

The unsignalized intersection of KY W 12<sup>th</sup> Street and Jillians Way fails in all conceptual alternatives. Four additional unsignalized intersections have approaches that would fail in Kentucky. Of signalized intersections in Kentucky, a total of seven different signalized intersections would fail. The Dixie Highway and Kyles Lane Intersection would fail in all alternatives as would the intersection of Highland Avenue and Kyles Lane.

No unsignalized intersections have approaches that fail in Ohio with Alternatives B, D, and E. In Alternative C, the westbound leg of the intersection of Court Street and Linn Street is the only unsignalized intersection that would show failure in Ohio in the PM peak hour. Seven different signalized intersections would fail in Ohio, depending on the alternative. Table 17 shows a comparison of intersections by conceptual alternative.

**Table 17. Comparison of Intersections by Conceptual Alternative**

Location	Alternative	Unsignalized Intersections	Signalized Intersections
<b>Kentucky</b>	No Build	One intersection has approaches that fail in both peak hours (W 12 <sup>th</sup> Street and Jillians Way).	Three intersections fail in one or both peak hours (Dixie Highway and Kyles Lane, I-75 NB ramps and Kyles Lane, and Highland Avenue and Kyles Lane).
	B	One intersection has approaches that fail in both peak hours (W 12 <sup>th</sup> Street and Jillians Way). One intersection (W 12 <sup>th</sup> Street and Bullock Street) fails in the PM peak hour.	Four intersections fail overall in one or both peak hours. These include the Pike Street/Jillians Way, Dixie Highway/Kyles Lane, I-75 NB ramps/Kyles Lane, and the Highland Avenue/Kyles Lane intersections.
	C	One intersection has approaches that fail in both peak hours (W 12 <sup>th</sup> Street and Jillians Way). One intersection (W 12 <sup>th</sup> Street and Bullock Street) fails in the PM peak hour.	Three intersections fail overall in one or both peak hours. These include the Pike Street/Jillians Way, Dixie Highway/Kyles Lane and Highland Avenue/Kyles Lane intersections.
	D	One intersection has approaches that fail in both peak hours (W 12 <sup>th</sup> Street and Jillians Way). One intersection (W 12 <sup>th</sup> Street and Bullock Street) has approaches that fail in the PM peak hour.	Four intersections fail overall in both peak hours and include the Dixie Highway/Kyles Lane, Highland Avenue/Kyles Lane, W 9 <sup>th</sup> Street/I-75 NB ramps, and W 9 <sup>th</sup> Street/I-75 SB ramps intersections. The W 9 <sup>th</sup> Street/I-71 NB ramps intersection fails in the AM peak hour.
	E	The W 12 <sup>th</sup> Street/Jillians Way intersection has approaches that fail in both peak hours. The westbound legs of the W 4 <sup>th</sup> Street/Crescent and W 5 <sup>th</sup> Street/Crescent intersections also fail in both peak hours. The northbound leg of the W 5 <sup>th</sup> Street/Bakewell intersection fails during the PM peak hour, and the southbound leg fails during both peak hours.	Two intersections fail during both peak hours (Dixie Highway/Kyles Lane and Highland Avenue/Kyles Lane). One intersection (I-75 NB ramps/Kyles Lane) fails in the AM peak hour.
	G	One intersection has approaches that fail in both peak hours (W 12 <sup>th</sup> Street and Jillians Way) and one intersection has approaches that fail in the PM peak hour (W 12 <sup>th</sup> Street and Bullock Street). The southbound leg of the W 5 <sup>th</sup> Street/Bakewell Street intersection fails in the AM peak hour.	Two intersections fail during both peak hours (Dixie Highway/Kyles Lane and Highland Avenue/Kyles Lane). Two intersections (I-75 NB Ramps/Kyles Lane and W 9 <sup>th</sup> Street/I-75 NB Ramps) fail in the AM peak hour.

**Table 17. Comparison of Intersections by Conceptual Alternative**

<b>Location</b>	<b>Alternative</b>	<b>Unsignalized Intersections</b>	<b>Signalized Intersections</b>
<b>Ohio</b>	No Build	No intersection approaches fail in either peak hour.	No intersections fail in either peak hour.
	B	No intersection approaches fail in either peak hour.	Three intersections fail overall in the PM peak hour (Central Parkway/Linn Street, W 4 <sup>th</sup> Street/Central Avenue, and W 3 <sup>rd</sup> Street/Central Avenue). The northbound movement at W McMillan/Central Parkway fails in the PM peak hour, and the eastbound and southbound movements fail at the Central Parkway/Linn Street intersection in the AM peak hour.
	C	The westbound leg of the Court Street/Linn Street intersection fails in the PM peak hour.	Two intersections fail during the PM peak hour (W 4 <sup>th</sup> /Central Avenue and W 3 <sup>rd</sup> /Central Avenue).
	D	No intersection approaches fail in either peak hour.	One intersection (W 5 <sup>th</sup> Street/Central Avenue) fails overall in the AM peak hour. The westbound and southbound movements at the Central Parkway/Linn Street intersection fail in the PM peak hour.
	E	No intersection approaches fail in either peak hour.	The Central Parkway/Linn Street intersection fails in the PM peak hour, and the W 7 <sup>th</sup> /8 <sup>th</sup> Street/I-71/I-75 SB Connector intersection fails in the AM peak hour.
	G	No intersection approaches fail in either peak hour.	The Central Parkway/Linn Street intersection fails in the PM peak hour.

## 4.2 Social Environment

### 4.2.1 Land Use

Land use is directly affected where land is converted to right of way and indirectly affected by changes to land use (Exhibit 13A – 13B). Table 18 shows the potential number of land use acres that would be converted to right of way by each conceptual alternative. The No Build Alternative would not affect land uses within the study area because any minor, short-term safety and maintenance improvements to the Brent Spence Bridge and I-75 corridor would be within the existing right of way.

**Table 18. Land Use Converted to Right of Way (Acres)**

Land Uses	Alternative B	Alternative C	Alternative D	Alternative E	Alternative G
<b>Kentucky</b>					
Residential	4.80	5.30	5.01	3.19	3.77
Industrial	5.61	0.00	0.00	0.00	0.35
Commercial	1.52	3.42	3.13	2.79	3.75
Undeveloped	13.19	3.24	3.08	3.35	8.05
Institutional	0.96	1.82	1.56	1.00	1.40
Other	0.37	0.00	0.00	0.00	0.00
<b>Subtotal KY</b>	<b>26.45</b>	<b>13.78</b>	<b>12.78</b>	<b>10.33</b>	<b>17.32</b>
<b>Ohio</b>					
Residential	0.14	0.15	0.16	0.16	0.27
Industrial	12.95	0.70	0.48	0.88	1.65
Commercial	5.30	1.14	0.93	1.50	1.29
Undeveloped	5.44	0.76	0.65	1.28	1.43
Institutional	7.18	1.37	1.17	2.17	3.24
Other	4.99	0.42	0.38	1.29	0.86
Undefined <sup>1</sup>	9.75	3.88	3.24	4.09	2.14
<b>Subtotal OH</b>	<b>45.76</b>	<b>8.51</b>	<b>7.01</b>	<b>11.37</b>	<b>10.88</b>
<b>Total</b>	<b>72.2</b>	<b>22.2</b>	<b>19.7</b>	<b>22.3</b>	<b>28.2</b>

Source: Cincinnati Area Geographic Information System (CAGIS) (2006)

<sup>1</sup>Undefined land uses are those that do not have a specified land use as noted by the source of the data.

Within Kentucky, impacts to land use would be the same for all conceptual alternatives south of KY 12<sup>th</sup> Street. Mostly open space would be converted in areas south of KY 12<sup>th</sup> Street. South of KY 12<sup>th</sup> Street, institutional uses would be converted to right of way by all alternatives, including a portion of a school property that is used for recreation. However, this impact would not change the activities of this property. Commercial uses between Kyles Lane and Dixie Highway would require the same amount of land use acreage by all conceptual alternatives. This is a loss of property but not a loss in the function of the land use. A parking lot would be impacted at the Central Nazarene Church near the Dixie Highway interchange. Land from the Saint Elizabeth Development, near 16<sup>th</sup> Street, would be impacted by all conceptual alternatives; however the use of the property as a hospital would not change.

Within Kentucky, Alternative B would convert residential land uses to right of way along Western and Crescent avenues. North of KY 12<sup>th</sup> Street, Alternative B would also convert residential and commercial land uses near the existing interstate. Alternative B

would require recreational land uses and activities utilized at Goebel Park. Alternative C would convert mostly residential, commercial, and undeveloped land uses. Residential land use would be impacted through loss of homes along Western and Crescent avenues and in Lewisburg. Commercial land would be lost through displacements north of KY 4<sup>th</sup> Street, adjacent to existing I-75, and near Pike Street. Alternative C would also require land from recreational uses and activities utilized at Goebel Park. Alternative D would impact the land uses in the same locations of Alternative C. Alternative E would convert residential land uses and open space to new right of way along Crescent Avenue and KY 12<sup>th</sup> Street in Lewisburg. Commercial land uses would be converted north of KY 4<sup>th</sup> Street and near Pike Street. Alternative E would impact the least amount of recreational land at Goebel Park while not impacting facilities at the park. Alternative G would convert mostly undeveloped, residential, and commercial land uses. Section 4.2.3 further discusses impacts to community facilities such as parks and schools. Displacements are further discussed in Section 4.2.7.

In Ohio, Alternative B would impact mostly industrial and commercial land uses within Queensgate and west of I-75 north of Findlay Street. Parking lots at office buildings not displaced would also be impacted in this area by Alternative B. Alternative C would have the most impact on institutional and commercial land uses to the east of I-75. Alternative D would convert mostly institutional and commercial land uses. Alternative E would convert mostly institutional and commercial land uses. Alternative E would also convert industrial, commercial, and residential uses north of Findlay Street on both sides of existing I-75. Alternative G would convert mostly institutional land uses and recreational uses at the Queensgate ballpark and land categorized as residential to the east of I-75. Alternative G would also require industrial and commercial land use for right of way in Queensgate. This would include a portion of a parking structure at OH 7<sup>th</sup> and Gest streets.

For the project corridor overall, Alternative B would convert the 72.2 acres of land to right of way. The majority of this impact would occur in the Queensgate area of Cincinnati. This is due to Alternative B's new bridge construction west of the Brent Spence Bridge and the new bridge's associated landing in Queensgate. Alternative G would convert 28.2 acres of land to right of way. Alternative B converts approximately less than four percent of total land uses in the study area while Alternative D, the lowest acreage impact, converts less than one percent of total land use in the study area.

In Ohio, Alternatives C, D, E, and G would all require conversion of utility to right of way at the Duke Energy power station. Alternatives C, D, and G would encroach on recreational land use at the Queensgate playground and ball field. Further discussion of recreational impacts is discussed in Section 4.2.3.1.

All alternatives north of Gest Street in Ohio would have a limited impact on existing and future land use. Some residential, commercial, and industrial uses adjacent to the existing right of way would be impacted by all conceptual alternatives equally, however the uses would not be precluded due to the amount of acreage required (Table 18). Some impacts are also only property takes that impact land and not a building or use that serves as the function to the property.



Within the study area, a number of planning efforts are either underway or are in the early stages of implementation by the City of Cincinnati. The status of the planning efforts was confirmed with City staff.

The *Queensgate South Redevelopment Plan* was adopted by Cincinnati City Council as the Queensgate South Urban Renewal Plan on September 25, 1996. This project is a 17 acre development of a former brownfield property that is currently being cleared for construction. According to City of Cincinnati staff, this property is being developed into a new business park that is expected to house new light industrial and office users, creating more than 500 jobs.

The *Queensgate Area Issues, Considerations and Recommendations for Implementation of the Brent Spence Bridge Project: HAM-71/75-0.00/0.22*) was adopted by Cincinnati City Council on September 24, 2008. A copy of the report was sent to State and Federal highway officials on September 30, 2008. The report summarized the consolidated perspective and viewpoint of the City of Cincinnati with regard to the issues, considerations and recommendations pertaining to alternatives currently under consideration for the Brent Spence Bridge Project.

The *GO Cincinnati* plan was finalized and presented by the Mayor of Cincinnati on January 22, 2008 as an effort to define an overall economic development strategy for the City. The report serves as a guide to help the City prioritize existing projects. Specific to the Brent Spence Bridge study limits, *GO Cincinnati* identifies the *Queensgate South Redevelopment Project* and the *West End Comprehensive Plan* as priorities.

In Kentucky, the Northern Kentucky Area Planning Commission's *Areawide Comprehensive Plan* was updated most recently on December 13, 2006.

Within the Queensgate area, Alternative B would not use existing land uses in a way that is compatible with land use plans and would go through areas where there are plans for redevelopment. Overall, Alternative G supports local land use except for in the location of the UPS building that would potentially be displaced by this alternative. By impacting the UPS building, Alternative G would remove industrial space from an area that has mostly industrial uses. However, this alternative also does not go through areas where redevelopment plans are identified in the Queensgate area. Alternatives C, D, E, and G would support the Queensgate redevelopment plans and help Cincinnati facilitate the renewal goals which are noted in the Queensgate redevelopment plans. The Queensgate South Redevelopment Plan is an incentive for businesses to locate in this area and plans to renew investment in the Queensgate industrial area. Alternatives C, D, E, and G also support Cincinnati's *GO Cincinnati* report. This economic development plan identifies Queensgate as a growth opportunity area.

#### **4.2.2 Neighborhood and Community Cohesion**

Public comments revealed a sense of cohesion within the community in the areas of Crescent Avenue and Covington, Kentucky. In Kentucky, Alternatives B and G would impact community cohesion by displacing residences on Crescent Avenue. Alternative B would also impact the community of Lewisburg, specifically on Western and Crescent avenues. This is where residences and businesses, such as restaurants and convenience stores, would potentially be relocated or displaced. Alternative C, D, and E are not expected to have an impact on community cohesion within Kentucky as the

transportation improvements would be completed within as much existing right of way as possible. Displacements also occur by all conceptual alternatives within the Lewisburg neighborhood and historic district on KY 11<sup>th</sup> and 12<sup>th</sup> streets. South of KY 12<sup>th</sup> Street, the conceptual alternatives mostly utilize existing right of way and therefore would not result in cohesion impacts to neighborhoods adjacent to the I-71/I-75 corridor.

In Ohio, Alternative B would impact community cohesion. The Queensgate area, noted as a neighborhood by the City of Cincinnati, would be impacted by Alternative B due to the roadway being developed on new alignment through this area. The primary land uses in this area are industrial and commercial and therefore this area is not a traditional cohesive residential community. With Alternative B, the ramps from I-71 to the proposed Ohio River bridge would pass through the Queensgate neighborhood. Alternatives C, D, E and G are expected to have a minimal impact on community cohesion because they would be constructed within as much existing right of way as possible and would not create new barriers between communities. North of Gest Street, all of the conceptual alternatives would displace residences in the West End and Fairview neighborhoods to accommodate changes at the Western Hills Viaduct.

None of the alternatives are expected to increase community interaction since the only barrier, I-75, would not be removed or provide new connections. No other changes in cohesion are expected to the neighborhoods in the study area.

The No Build Alternative would not affect community cohesion within the study area because any minor, short-term safety and maintenance improvements to the Brent Spence Bridge and I-75 corridor would be within the existing right of way.

### **4.2.3 Community Facilities and Resources**

#### **4.2.3.1 Parks and Recreation**

Goebel Park would be impacted by the widening of the interstate by all conceptual alternatives. Goebel Park is 12.68 acres. Alternatives B, C, and D would each impact a parking lot, basketball courts, and walking path located on the west side of the park adjacent to the interstate. Alternative G would impact the same parking lot and basketball courts as Alternatives B, C, and D, but would avoid impacts to the walking path. Alternative E would require 0.35 acres of land only adjacent to the interstate. A neighborhood pool, located in Goebel Park is not expected to be directly impacted by any of the conceptual alternatives. The total acreage impacts to Goebel Park, including Kenney Shields Park, and percentage of the total park impacted are listed in Table 19.

**Table 19. Kentucky Recreation Facilities Impacts**

<b>Property/Facility</b>	<b>Description/Amenities</b>	<b>Ownership</b>	<b>Alternative Impacts (% of Total Property)</b>
Goebel Park and Pool Complex	Park area; city gardens at KY 5 <sup>th</sup> Street; basketball courts at KY 9 <sup>th</sup> Street; passive areas; picnic shelters; tot lots; walking paths	Owned by City of Covington	Alternative B 1.86 acres (14.7%) Alternative C 2.6 acres (20.5%) Alternative D 1.94 acres (15.3%)
Kenney Shields Park (element of Goebel Park)	Small neighborhood corner lot with playground equipment	Owned by the City of Covington	Alternative E 0.35 acres (3%) Alternative G 0.78 acres (5.7%)
Devou Park and Golf Course	700-acre park and golf course	Owned by the City of Covington	No impact

In Ohio, the Queensgate playground and ball fields would be impacted by Alternatives C, D, and G. The proposed right of way limits for the alternatives would encroach upon the western edge of the property adjacent to I-75 resulting in a sliver take of the 5.26 acre property. Alternative D would require 0.45 acres from the park. The existing ball diamond does not fall within the proposed existing right of way of this alternative. Alternatives B and E would not require property from the Queensgate playground and ball fields. The Queensgate playground and ball fields provide recreation to the West End neighborhood. The amount of acreage impacted by each conceptual alternative is listed in Table 20. Impacts are also shown in Exhibits 11A – 11E.

**Table 20. Ohio Recreation Facilities Impacts**

<b>Property/Facility</b>	<b>Description/Amenities</b>	<b>Ownership</b>	<b>Alternative Impacts (% of Total Property)</b>
Laurel Park – Union Terminal	Greenspace	Owned by the City of Cincinnati	No impact
Queensgate playground and ball fields	Playground and ball fields	Owned by the City of Cincinnati	Alternative C 0.31 acres (5.9%) Alternative D 0.45 acres (8.5%) Alternative G 0.29 acres (5.5%)
Lincoln Community Center	Pool, playground, tennis court, basketball courts	Owned by the City of Cincinnati	No impact
Cincinnati Riverfront Park	Planned to include commemorative areas, passive areas, playground, promenades, bike trail	Owned by the City of Cincinnati	No impact

The Cincinnati Riverfront Park has been planned to be located on the Ohio riverfront in the area between Great American Ballpark and Paul Brown Stadium. According to the Cincinnati Parks Department, the planned park's western boundary is not expected to interfere with the Brent Spence Bridge. No other parks in Ohio are expected to be impacted by the conceptual alternatives.

The No Build Alternative would not affect park and recreation areas within the study area because any minor, short-term safety and maintenance improvements to the Brent Spence Bridge and I-75 corridor would be within the existing right of way.

#### **4.2.3.2 Schools and Churches**

A number of schools and churches were identified in the *Planning Study Report* (2006) within the study area. There are two schools and one church located within the potential impact limits of all conceptual alternatives. The Notre Dame Academy in Kentucky, a private institution, has the potential to be impacted by all of the alternatives. A total of 0.10 acres would be impacted on this property in the area of existing tennis courts by all of the conceptual alternatives. An additional 0.28 acres would be required to the south of the school in the area of property expansion plans. The Central Church of the Nazarene, near the Dixie Highway interchange, is located within the potential impact limits of all five conceptual alternatives. A total of 0.66 acres would be required from the parcel of the church, including portions of the parking lot, by all of the alternatives.

The parcel of the Cincinnati - Hamilton County Community Action Agency / Theodore M. Berry Head Start school is adjacent to the potential impact limits of all conceptual alternatives; however the facility is not expected to be impacted by any of the alternatives.

The No Build Alternative would not affect schools and churches within the study area because any minor, short-term safety and maintenance improvements to the Brent Spence Bridge and I-75 corridor would be within the existing right of way.

The locations of schools and churches in relation to the construction limits of the conceptual alternatives are shown in Exhibit 11A – 11E.

#### **4.2.3.3 Social Services**

Groups that provide social services to neighborhoods in the study area are not expected to be impacted by any of the conceptual alternatives or the No Build Alternative. The parcel of the Cincinnati - Hamilton County Community Action Agency / Theodore M. Berry Head Start school is adjacent to the construction limits of all alternatives; however the facility is not expected to be impacted. The parcel of the Cincinnati Job Corps Center is adjacent to the construction limits of the conceptual alternatives; however it is not expected to be impacted. No social service groups in Kentucky were identified within the construction limits of conceptual alternatives.

#### **4.2.4 Public Safety and Emergency Services**

Emergency response is expected to improve due to reduced traffic congestion resulting from the conceptual alternatives. While all alternatives would utilize a collector-distributor system at some point throughout the project corridor, there will be fewer access points to the I-75 mainline. The City of Cincinnati has indicated that the preliminary nature of each of the alternative's impact would be the same for each of the alternatives at this step of the project development process. However, the City noted that alternatives that introduce trenches would have a negative impact on emergency response times due to limited access points. The proposed alternatives may produce a trench where local routes are below grade and the mainline is a bridge over a series of access points and could create longer emergency response times to mainline I-75. The

access points for Alternative B would be at KY 9<sup>th</sup> Street and at least as far north as Ezzard Charles Drive. Alternatives C, D, and G would potentially have a trench between KY 9<sup>th</sup> Street and Linn Street. Access points would remain similar to existing conditions for Alternative E.

New bridges on new alignments that are part of Alternative B have the potential to create isolated areas and areas underneath bridges in both Kentucky and Ohio. Alternatives C, D, E, and G are not anticipated to create new isolated areas.

The No Build Alternative would not improve public safety or emergency response times within the study area because any minor, short-term safety and maintenance improvements to the Brent Spence Bridge and I-75 corridor would not improve traffic capacity on the interstate system.

#### **4.2.5 Social Groups**

Elderly and disabled populations can be affected by a transportation project. No concentrations of elderly or disabled populations are expected to be disproportionately impacted by the conceptual alternatives or the No Build Alternative. These social groups are not expected to experience changes in mobility and accessibility. Changes to bus stop locations are not proposed as part of the project, and therefore, the alternatives should have no effect. The effect of the project on minority and low-income populations are further discussed in the environmental justice Section 4.2.9.

#### **4.2.6 Travel Patterns and Accessibility**

Travel patterns and accessibility to local areas would be altered by the conceptual alternatives. Generally, communities would still have access to I-71 and I-75 though they may not be direct where I-75 is separate from local traffic. Southbound access to Covington, its businesses, services, and facilities would change. Direct southbound access from I-71 and I-75 to Covington would not be provided by Alternatives B, C, D, and G. Use of a local collector-distributor (C-D) roadway will provide the access. However, a motorist travelling southbound must make a decision north of the Ohio River to use the C-D roadway to access Covington. If that decision is not made, access would be impeded. Alternative E provides direct southbound access to Covington. According to the City of Cincinnati, a benefit may occur for movement between Queensgate and I-75. Access to US 50 to and from Queensgate and the Cincinnati business district would remain unchanged for Alternatives B, C, D, and G. Alternative E proposes an intersection to provide US 50 access to and from Queensgate and the Cincinnati business district.

Travel patterns would change when transitioning from the interstate to local routes since the project separates local and interstate traffic. However, local traffic would still be able to access the adjacent neighborhoods with modifications to ramps and local roadways. Travel patterns within neighborhoods would likely not change since local routes would not be physically changed by any of the conceptual alternatives.

Connectivity within and between communities/neighborhoods is not anticipated to change since local routes would remain the same and new local routes are not proposed. This project would neither encourage nor discourage existing connectivity between neighborhoods in the study area.

The No Build Alternative would not affect travel patterns and accessibility within the study area because any minor, short-term safety and maintenance improvements to the Brent Spence Bridge and I-75 corridor would be within the existing right of way.

#### **4.2.7 Displacements and Relocations**

A *Relocation Assistance Program Conceptual Survey (January 2007)* and *Conceptual Stage Relocation Report (February 2007)* were completed for Ohio and Kentucky, respectively, to identify potential displacements and relocations resulting from the conceptual alternatives. The reports also discussed the availability of relocation opportunities in the area. These reports originally estimated displacements and relocations based on the study area. To provide an update to the relocation reports from 2007, a survey was distributed to businesses to determine the potential employment and property impact by the project. The survey was administered in January 2009. Businesses were asked to note the number of current employees and relocation options should they be displaced. Businesses were asked where they would relocate or if there was no impact to their business.

Property impacts and displacements were estimated by using Cincinnati Area Geographic Information System (CAGIS) and Hamilton County Auditor information, project aerial photography, field review, and construction limits of the conceptual alternatives. The No Build Alternative would not result in displacements within the study area because any minor, short-term safety and maintenance improvements to the Brent Spence Bridge and I-75 corridor would be within the existing right of way.

##### **4.2.7.1 Residential Displacements**

More residential displacements are expected in the Kentucky than in Ohio due to the type of land uses in the study area (Exhibit 21A – 21D). The majority of residences in Kentucky are single-family. Within Kentucky, residential displacements are concentrated on Western Avenue by Alternative B and Crescent Avenue by Alternatives B and G. Residential displacements also occur within the Lewisburg Historic District by all conceptual alternatives along Crescent Avenue, and KY 11<sup>th</sup> and KY 12<sup>th</sup> streets. Additional residential displacements within Kentucky are near the southern project limits. Several residential properties would have parcel impacts but would not result in a displacement.

All of the alternatives are expected to displace the same residences within Ohio in the area of the Western Hills Viaduct. These displacements include apartments, single-family, and two-family dwellings. These displacements would result from the reconfiguration of Western Hills Viaduct. An additional residential displacement is expected by Alternatives E and G along Western Avenue.

Potential displacements, for residential units and number of persons by alternative, within Kentucky and Ohio are shown in Table 21. A list of residences displaced by alternative is in Table 23. The number of parcels impacted is presented in Appendix D.

**Table 21. Estimated Residential Displacements**

Alternative	Ohio		Kentucky	
	Residential Units	Persons	Residential Units	Persons
Alternative B	5	10 – 36	38	65-260
Alternative C	5	10 – 36	11	13-52
Alternative D	5	10 – 36	11	13-52
Alternative E	6	11 – 40	13	12-48
Alternative G	6	11 – 40	25	28-112

The *Relocation Assistance Program Conceptual Survey* and *Conceptual Stage Relocation Report* estimated the number of families and businesses which may be displaced by the project. The *Conceptual Stage Relocation Report* estimated the number of bedrooms per unit of potential displaced residences. The households were assumed to have four or less people based on studies. Based on this assumption, calculations for the number of persons displaced used a range of 1 to 4 persons per residential unit displaced. Alternatives C, D, E, and G are estimated to displace less than 0.5 percent of the total population within the Census tracts that comprise the study area in Kentucky. Alternative B is estimated to displace less than one percent of residents in Kentucky. All conceptual alternatives are estimated to displace less than 0.5 percent of the total population within the Census tracts that comprise the study area in Ohio.

The relocation reports concluded that the majority of displaced persons would be able to be relocated. There is enough housing available within comparable price ranges and within the income ranges of those persons displaced. Last Resort Housing may be necessary for low-income and rental units. Last Resort Housing may be applied if comparable housing, related to an occupant's financial means, and is not available to those displaced. Last Resort Housing is a method by which supplemental payments in excess of the normal cost limits may be approved. The acquisition and relocation for all residences displaced for new highway right-of-way would be conducted in accordance with state and federal directives, in compliance with the Federal Uniform Relocation and Real Property Acquisition Policies Act of 1970, the Surface Transportation and Uniform Relocation Assistance Act and 49 CFR Part 24.

Within Kentucky, the relocation report indicated that there appears to be enough homes available within less than five miles that are comparable to most of the potential displacements. However, homes over \$200,000 would be more difficult to locate for relocations. There appeared to be large number of renter-occupied homes in Kentucky that would be displaced. Within Ohio, potential residential displacements make up less than two percent of the existing population (for the two Census tracts where impacts occur) for Alternatives B, C, D, E, and G. The residential displacements for any of the alternatives are located within Census tracts where 15 to 40 percent of the population is below poverty. These displacements are also within Census tracts with high percentage minority population.

**4.2.7.2 Business Displacements**

The estimated business displacements that fall within the construction limits of the conceptual alternatives were identified (Exhibit 21A – 21D). If any portion of a business'

**ODOT PID 75119**  
**KYTC Item No. 6-17**  
**Conceptual Alternatives Study**

building fell within the impact limits of a conceptual alternative, then it was noted as a potential displacement. The No Build Alternative would not result in any business displacements within the study area because any minor, short-term safety and maintenance improvements to the Brent Spence Bridge and I-75 corridor would be within the existing right of way.

Number and Location of Displacements

Within Kentucky, business displacements would be located along KY 3<sup>rd</sup> and 4<sup>th</sup> streets, Crescent Avenue, and Pike Street. Alternative G would potentially displace businesses on Crescent Avenue and Pike Street. Within Ohio, business displacements would occur west of I-75 in the Queensgate area, Dalton Avenue, Spring Grove Avenue, and York Street. Displacements are also estimated to occur in the area of the Western Hills Viaduct due to new interchange configuration. Potential business displacements and estimated number of employees displaced by the conceptual alternatives are shown in Table 22.

**Table 22. Estimated Business Displacements**

Alternative	Ohio		Kentucky		Total	
	Businesses	Estimated Number of Employees	Businesses	Estimated Number of Employees	Businesses	Estimated Number of Employees
Alternative B	26	1,791 – 1,831	8	121 – 158	34	1,912 – 1,989
Alternative C	31	242 – 283	4	90 – 115	35	332 - 398
Alternative D	30	164 – 190	4	90 – 115	34	254 - 305
Alternative E	35	327 – 363	4	90 – 115	39	417 - 478
Alternative G	34	1,215 – 1,251	7	103 – 140	41	1,318 – 1,391

Businesses displaced and their locations are listed by alternative in Table 23. The number of parcels impacted is presented in Appendix D. The identification numbers correspond to Exhibits 21A – 21D. Kentucky businesses are noted by map ID of “KY” and Ohio businesses are noted by map ID of “OH.”

**Table 23. Potential Displacement Locations**

Map ID	Property Owner or Business Name	Property Address	Land Use	Alternative Impact
<b>Kentucky</b>				
KY-1	Hampton Inn	202-04 Crescent Avenue	Commercial	B
KY-2	Willie’s Sports Café	401 Crescent Avenue	Commercial	B
KY-3	Corken Steel Products	680 W Fourth Street	Commercial	B
KY-4	Lawrence Callahan	526 Western Avenue	Residential	B
KY-5	Larry D Jenkins	524 Western Avenue	Residential	B
KY-6	Richard & Kimberly Kessler	522 Western Avenue	Residential	B



**Table 23. Potential Displacement Locations**

<b>Map ID</b>	<b>Property Owner or Business Name</b>	<b>Property Address</b>	<b>Land Use</b>	<b>Alternative Impact</b>
KY-7	Raymond & Deborah Reinhart	520 Western Avenue	Residential	B
KY-8	Jason R Merrill	518 Western Avenue	Residential	B
KY-9	Audrey Blair-Gentry	516 Western Avenue	Residential	B
KY-10	Brent Bleh Jr.	514 Western Ave.	Residential	B
KY-11	Jeffrey & Leslie Hendricks	512 Western Avenue	Residential	B
KY-12	John Taylor	510 Western Avenue	Residential	B
KY-13	Danny R & Neva J Francis	508 Western Avenue	Residential	B
KY-14	Ben Herndon	506 Western Avenue	Residential	B
KY-15	Norman & Catherine Obanion	801 Highway Avenue	Commercial	B
KY-16	Charles W Rowland	203 Western Avenue	Residential	B
KY-17	Michael Frazier	205 Western Avenue	Residential	B
KY-18	Huntington Properties	213 Western Avenue	Residential	B
KY-19	Julius Trammer	223-25 Western Avenue	Residential	B
KY-20	Rinzy & Kim Nocero	227 Western Avenue	Residential	B
KY-21	Jessica Kupper	233 Western Avenue	Residential	B
KY-22	January Durban	237 Western Avenue	Residential	B
KY-23	Chris Rice	311 Western Avenue	Residential	B
KY-24	Jennifer Gunning	313 Western Avenue	Residential	B
KY-25	Donald & Willena B Pulsfort	319 Western Avenue	Residential	B
KY-26	Jeffery Altenaw	429 Western Avenue	Residential	B
KY-27	Kristen Schmidt	431 Western Avenue	Residential	B
KY-28	Deborah Bramlage	501 Western Avenue	Residential	B
KY-29	Clifford Riverview Properties	604 Western Avenue	Residential	B
KY-30	Harry & Teresa Stadlander	606 Western Avenue	Residential	B
KY-31	Harry & Teresa Stadlander	608-10 Western Avenue	Residential	B
KY-32	James Nelson	616 Western Avenue	Residential	B

**Table 23. Potential Displacement Locations**

<b>Map ID</b>	<b>Property Owner or Business Name</b>	<b>Property Address</b>	<b>Land Use</b>	<b>Alternative Impact</b>
KY-33	Bedd Scenic View LLC	619 Western Avenue	Residential	B
KY-34	Thomas McMurray	622 Western Avenue	Residential	B
KY-35	Bedd Scenic View LLC	630 Western Avenue	Residential	B
KY-36	Michael McQuery & Deborah	632-34 Western Avenue	Residential	B
KY-37	Peter Thornton & Trula	636 Western Avenue	Residential	B
KY-38	City of Covington	670 Fourth Street W	Residential	B, C, D, E, G
KY-39	Pike Pro LLC	555 Pike Street	Commercial	B, C, D, E, G
KY-40	Pinnacle Realty Partners	804 Crescent Avenue	Residential	B, C, D, E, G
KY-41	Melody L Walls & Patricia M Becker	806-08 Crescent Avenue	Residential	B, C, D, E, G
KY-42	Pinnacle Realty Partners	812 Crescent Avenue	Residential	B, C, D, E, G
KY-43	Jeremy R Wallace	822 Crescent	Residential	B, C, D, E, G
KY-44	Pan Yong	824 Crescent	Residential	B, C, D, E, G
KY-45	Jeffery Grefer & Lori	605 11th Street	Residential	B, C, D, E, G
KY-46	Sam Properties LLC	1971 Pieck Drive	Residential	B, C, D, E, G
KY-47	Susan & William Osterhage	45 Rivard Drive.	Residential	B, C, D, E, G
KY-48	Joseph Finan	606 11th Street	Residential	B, C, D, E, G
KY-49	Charlotte & Marie Froelicher	604 12th Street	Residential	B, C, D, E, G
KY-50	Third Street, LLC	673-75 Third Street W	Residential	B, G
KY-51	I-75 Package Liquors & Wines INC	431-529 Crescent Avenue	Commercial	B, G
KY-52	Louis & Sandra Estes	816 Crescent Avenue	Residential	C, D, E, G
KY-53	Charles & Lillian Johnson	818 Crescent Avenue	Residential	C, D, E, G
KY-54	City of Covington	669-71 W Third Street	Commercial	C, G, D, E
KY-55	Rusk Heating and Air Condition	664-66 W Third Street	Commercial	C, G, D, E
KY-56	Felecia Claxton	820 Crescent Avenue	Residential	E, G
KY-57	Kelly L. Wagoner	601-03 Crescent Avenue	Residential	G

**Table 23. Potential Displacement Locations**

<b>Map ID</b>	<b>Property Owner or Business Name</b>	<b>Property Address</b>	<b>Land Use</b>	<b>Alternative Impact</b>
<b>Kentucky</b>				
KY-58	Connie Roberts	605 Crescent Avenue	Residential	G
KY-59	Jack Readnour	607 Crescent Avenue	Residential	G
KY-60	Kelly S. & Micheal Mattingly	609 Crescent Avenue	Residential	G
KY-61	Mark R. Hanauer	611-13 Crescent Avenue	Residential	G
KY-62	Tony Saberton	615-17 Crescent Avenue	Residential	G
KY-63	Kelly S. Mattingly	621 Crescent Avenue	Residential	G
KY-64	Joseph W & Norma Cotton	625 Crescent Avenue	Residential	G
KY-65	David Johnson	635 Crescent Avenue	Residential	G
KY-66	Robert J & Julie Mann	641 Crescent Avenue	Residential	G
KY-67	Visions Development Group LLC	725 Crescent Avenue	Residential	G
KY-68	Visions Development Group LLC	729 Crescent Avenue	Residential	G
KY-69	Visions Development Group LLC	731 Crescent Avenue	Residential	G
KY-70	Harry & Teresa Stadtlander	521 Western Avenue	Residential	B
KY-71	Kelly S. Mattingly	619 Crescent Avenue	Residential	B, G
KY-72	Deborah Bramlage	507 Western Avenue	Residential	B
KY-73	Michael & Deborah McQuery	509-13 Western Avenue	Residential	B
KY-74	Michael Vojas	515-17 Western Avenue	Residential	B
KY-75	Donald Martin	638 Western Avenue	Residential	B
KY-76	Arthur & Donna Schneider	640 Western Avenue	Residential	B
KY-77	Ralph & Elva Hasenbein	834 Crescent Avenue	Residential	B, G
<b>Ohio</b>				
OH-1	Fuller Ford	900 W Eighth Street	Automobile sales and service	B
OH-2	Zone Communications	909 Eighth Street	Office buildings - 1 and 2 stories	B
OH-3	Various – Sunoco; Subway; Krispy Kreme	844 W Seventh Street	Automotive service station	B
OH-4	Provident Bank	717 Linn Street	Full service bank	B

**Table 23. Potential Displacement Locations**

<b>Map ID</b>	<b>Property Owner or Business Name</b>	<b>Property Address</b>	<b>Land Use</b>	<b>Alternative Impact</b>
OH-5	George Fern Company	645 Linn Street	Light Manufacturing and assembly	B
OH-6	UPS	500 Gest Street	Industrial warehouse	B, G
OH-7	ARTIMIS	602 W Fourth Street	Office Buildings	B, C, D, E, G
OH-8	Duke Energy	Gest Street	Commercial / Utility	B
OH-9	Butternut Breads	747 W Fifth Street 805 W Fifth Street	Food and drink proc plants and storage	B
OH-10	Cincinnati Bulk Terminal	800 W Fifth Street	Food and drink proc plants and storage	B
OH-11	CCA Properties of America LLC	516 [528] Linn Street; 865 Carlisle Avenue	Other commercial structures	B
OH-12	Hudephol Square LLC	Vacant/801 W Sixth Street	Other industrial structures	B
OH-13	West Fifth Lofts LLC	840 W Fifth Street	Food and drink proc plants and storage	B
OH-14	CBT Solutions on Demand	737 W Sixth Street	Industrial warehouse	B
OH-15	K4 Architecture LLC	555 Gest Street	Other industrial structures	B
OH-16	Longworth Hall – Various Businesses	Gest Street/700 W. Pete Rose Way	Other commercial structures	Alt. B - parcel boundary; Alt. C, D, E, G
OH-17	Kuhr Family LTD Partnership	237 Gest Street	Other industrial structures	B
OH-18	MPEMR LLC	1850 Dalton Avenue	Light Manufacturing and assembly	Alt. E; Parcel only - Alt. C, G
OH-19	Harris & Marjorie Loftsring Family Partnership	1830 Dalton Avenue	Other retail structures	Alt. E; Parcel only - Alt. C, G
OH-20	Gold Star Chili	2022 Western Avenue	Drive-in restaurant or food service	Alt. B, C, E, G; Alt D - parcel only
OH-21	Big Cat Family Limited Partnership	1155 Harrison Avenue	Industrial warehouse	B, C, D, E, G
OH-22	BS Company	1136 Harrison Avenue	Light Manufacturing and assembly	B, C, D, E, G
OH-23	Linda Bailey & Robert Oberding	2405 W McMicken Avenue	Residential	B, C, D, E, G
OH-24	Richard T Borchers	2407 W McMicken Avenue	Residential	B, C, D, E, G
OH-25	Gerhard B Schulte	2409 W McMicken Avenue	Two family Residential	B, C, D, E, G
OH-26	Harold A Schuck	2411 W McMicken Avenue	Residential	B, C, D, E, G
OH-27	Olurotimi T Elemide	2413 W McMicken Avenue	Residential	B, C, D, E, G

**Table 23. Potential Displacement Locations**

<b>Map ID</b>	<b>Property Owner or Business Name</b>	<b>Property Address</b>	<b>Land Use</b>	<b>Alternative Impact</b>
OH-28	444 W Third Street LLC	444 W Third Street	Commercial warehouse	B, C
OH-29	City of Cincinnati	426 W. Fourth Street	Warehouse	B, D, E, G
OH-30	Jasin Inc	2310 Central Parkway	Retail - gas station	B, C, D, E, G
OH-31	Duke Energy	Front Street/646 Mehring Way	Utility/Commercial	C, D, E, G
OH-32	Robert Corman	603 W Pete Rose Way	Commercial - restaurant	E, G
OH-33	Phoenix Graphics Inc	W Court Street	Office buildings	C, D
OH-34	Hilltop Concrete Corp	612 Mehring Way	Other industrial structures	Alt. E, G
OH-35	City of Cincinnati	857 Mehring Way	Other industrial structures	B
OH-36	Martin Media	1116 York Street	Residential	E, G
OH-37	Wegman Investments LTD	1101 York Street	Industrial warehouse	E, G
OH-38	Karen Blackburn-Ivy	2408 Spring Grove Avenue	Commercial - Restaurant; cafeteria and/or bar	B, C, D, E, G

**Relocation Potential**

KYTC and ODOT conducted a survey of businesses in the study area in January 2009 to determine the potential employment and property impacts by the project. Businesses potentially displaced by the conceptual alternatives were asked where they would relocate to if they were displaced and how many employees would be affected. Copies of the returned surveys are in Appendix E. The following is a summary of the survey results:

- In Kentucky, 3 businesses (10 percent of businesses that were mailed the survey) returned the survey. One business stated if impacted they would relocate out of Kentucky. Two businesses indicated they would close if their business was displaced. These three businesses account for 93 employees.
- In Ohio, 36 businesses (41.4 percent of businesses that were mailed the survey) returned the survey.
- The majority of businesses that responded indicated they would not be impacted by the project. This includes the businesses located at 644 Linn Street where the office building would not be within construction limits but the parking lot serving the property would be impacted.
- Eight businesses indicated they would relocate out of Cincinnati if displaced by the project. This includes United Parcel Service (UPS) which is the largest employer in the Queensgate area.
- Seven businesses would relocate out of Ohio and three businesses indicated that they would close.

- The majority of businesses are located within Longworth Hall at 700 Pete Rose Way and at 644 Linn Street. UPS has the most employees (919) of potentially displaced businesses in the Queensgate area.

As noted in the relocation reports, businesses affected within Kentucky would be able to relocate within the area in either existing structures or new construction, should they choose to do so. Businesses, including office, industrial, and manufacturing operations, displaced in Ohio should be able to relocate within the Cincinnati area, if desired.

Number of employees displaced

There are approximately 15 Kentucky businesses within the construction limits of the conceptual alternatives. The majority of employees impacted in Kentucky are employed at Liquor Direct/Discount Tobacco, Hampton Inn, and Bill's Auto Sales and Service Center. Alternatives C, D, E, and G would displace the Liquor Direct/Discount Tobacco, which is estimated to have the most employees of displaced businesses. The second largest employer, Bill's Auto Sales and Service Center, would be displaced by all conceptual alternatives.

The largest Ohio employers in the study area include UPS, Butternut Breads, United States Postal Service (USPS), Duke Energy, and National City in Queensgate. Within a ½ mile of the Brent Spence Bridge there are 5,094 employees in Ohio, this includes the Cincinnati Central Business District. Out of 5,094 employees within a ½ mile radius of the bridge, 919 (18 percent) are employed by UPS and have the potential to be impacted (loss of job or relocation) and would contribute to the most displacements. This business would be impacted by Alternatives B and G. The northeast corner of the UPS building is within the Alternative G impact limits. Impacts to the UPS building could possibly be avoided by Alternative G through further design study. However, at this phase of project development, UPS is considered a displacement under Alternative G since part of the business falls within impact limits. Butternut Bread is also a larger employer with 200 (four percent) employees that could be impacted. This business would be displaced by Alternative B. While Duke Energy property throughout Queensgate will be impacted, employees are not estimated to be displaced. Approximately 35 percent of employees within a ½ mile radius of the Brent Spence Bridge would be impacted (displaced) by Alternative B, 24 percent by Alternative G, seven percent by Alternative E, five percent by Alternative C, and three percent by Alternative D.

Highway-related businesses include gas stations/service stations, convenience stations, restaurants/drive-thru, hotels/motels, and any other type of business that caters to local and regional traffic. Within Kentucky, four highway-related businesses have the potential to be displaced. Within Ohio, two highway-related businesses have the potential to be displaced. Table 24. lists potential displacement to highway-related businesses by alternative.

**Table 24. Highway-related Business Displacements within Impact Area**

Alternative	Ohio	Kentucky
Alternative B	1 gas station/convenience store	1 hotel (Hampton Inn); 1 restaurant (Willie's Sports Café); 1 convenience store (Cork N Bottle)
Alternative C	1 Drive-thru restaurant (Gold Star Chili)	None
Alternative D	None	None
Alternative E	1 Drive-thru restaurant (Gold Star Chili)	None
Alternative G	1 Drive-thru restaurant (Gold Star Chili)	2 convenience stores (Cork N Bottle; Liquor Direct/Discount Tobacco)

## 4.2.8 Economy and Employment

### 4.2.8.1 Economic Impact

The loss in property revenue would occur where land is converted to right of way for the conceptual alternatives. Loss of residential and commercial properties by all conceptual alternatives would result in decreased revenues from lost property taxes. The property value of residences close to the I-71/I-75 corridor could decrease due to change in views and therefore decrease in quality of life. Also the value could decrease for sites left near the widened interstate as opposed to being displaced.

The No Build Alternative would not result in any economic impacts resulting from land use conversion within the study area because any minor, short-term safety and maintenance improvements to the Brent Spence Bridge and I-75 corridor would be within the existing right of way.

All conceptual alternatives would result in the loss of property value and property taxes. In Kentucky, the estimated property value loss for each conceptual alternative is: Alternative B - \$16 million; Alternative C, D, and E - \$2.1 million; and Alternative G - \$3.9 million. In Ohio, the estimated property value loss for each conceptual alternative is: Alternative B - \$40.1 million; Alternative C - \$13.3 million; Alternative D - \$10.4 million; Alternative E - \$11.3 million; and Alternative G - \$17.2 million.

Within Ohio, 31 of the 52 impacted properties (59.6 percent) are tax abated. The total taxes collected in Ohio in 2006 were \$3,239,162. Alternative B would result in the loss of 10 percent of taxes collected by the city of Cincinnati. Alternatives C, D, and E would result in a loss less than 1.5 percent of taxes collected. Alternative G would result in a 2.9 percent loss of property taxes.

Currently, developable land exists in Queensgate at the Queensgate South Development Site. According to Grubb & Ellis statistics for Fourth Quarter 2008 (supplied by the City of Cincinnati), 5.3 percent of industrial property (total square feet) is available in the central portions of Cincinnati and approximately 2.2 percent of industrial property (total square feet) is available in Covington. The likelihood of businesses relocating that would be displaced by this project was investigated through a survey. The majority (66 percent) of businesses in Ohio that replied indicated that they would not relocate out of Cincinnati or the state or would not be impacted by this project. Within

Kentucky, none of the three surveys received indicated a business would relocate within Covington or the state.

Local traffic would continue to have the same access to existing businesses, however, under Alternatives B, C, D, and G, I-75 traffic would generally not have access to local businesses between KY 12<sup>th</sup> Street north to Ezzard Charles Drive in the northbound direction and between Western Hills Viaduct and KY 9<sup>th</sup> Street in the southbound direction. Since all alternatives separate local and interstate traffic, highway-related businesses in Covington would potentially lose some business resulting from changes in accessibility for regional traffic.

The City of Cincinnati conducted a study (*Queensgate Area Issues, Considerations and Recommendations for Implementation of the Brent Spence Bridge Project: HAM-71/75-0.00/0.22 [September 2008]*) on the impacts to the Queensgate area by proposed alternatives. The report discusses economic impacts that may occur in Queensgate as a result of this project. The City of Covington submitted a letter on October 8, 2008 discussing their evaluation of direct and indirect economic impacts of proposed alternatives (Appendix E).

#### **4.2.8.2 Employment**

There is the potential to lose employment from businesses that would be displaced and relocated. The estimated number of employees that would be displaced by the conceptual alternatives is shown in Table 22. The No Build Alternative would not displace any employees. Employees would be displaced from mostly industrial type of businesses, plus automotive service, convenience stores and restaurants, and some office buildings. The businesses that would contribute to the majority of displaced employees include Willie's Sports Café and Hampton Inn in Kentucky and UPS, Duke Energy, and Butternut Breads in Ohio.

Within a ½ mile of the Brent Spence Bridge there are 5,094 employees in Ohio, this includes portions of the Central Business District. As discussed in Section 4.2.7.2, UPS employees the highest number of people in the study area and accounts for 18 percent of the employees within ½ mile of the existing bridge. This facility would be impacted by Alternatives B and G. Approximately one-fourth (26 percent) of employees within ½ mile radius of the Brent Spence Bridge would be impacted (displaced) by Alternative B, seven percent by Alternative G, five percent by Alternatives C and E, and three percent by Alternative D.

Loss of employment would add to the Greater Cincinnati's unemployment rate of 6.1 percent that is currently lower than the state rate of 7.3 percent (December 2008).

Alternative B would result in the largest impact on employment in both Kentucky and Ohio when compared to Alternatives C, D, E, and G. In Ohio, Alternative G would have a greater impact than Alternatives C, D, and E. Within Kentucky, Alternative G would displace the least number of employees while Alternatives C, D, and E would have comparable impacts on employment as noted in Table 22.

#### **4.2.8.3 Business Districts**

Loss of residences by Alternatives B, E, and G can reduce the number of patrons to Mainstrasse and Covington if they are not able to relocate and would reduce the



property and income taxes. Each alternative is estimated to displace businesses within clusters located along Pike Street in Covington.

Business district impacts anticipated in Ohio would result from Alternatives B and G which would impact businesses within the Queensgate business district. Alternatives B and G would result in the loss of jobs and business opportunity, loss of earnings and property taxes due to displacements. Alternatives C, D, and E would have less impact to business districts compared to Alternatives B and G due to less expected displacements and loss of employees, and lower property value and tax losses. The Cincinnati Central Business District is not expected to have a direct impact due to loss of property value and taxes, loss of displaced employees, or change in land uses.

The No Build Alternative would not impact any business districts within the study area because any minor, short-term safety and maintenance improvements to the Brent Spence Bridge and I-75 corridor would be within the existing right of way.

Other economic impacts would result from the loss of parking available to existing businesses that would not have structure impacts. The office building at 644 Linn Street is occupied by approximately 30 businesses and currently has over 200 employees (according to only January 2009 survey respondents). This parking lot is within the construction limits of Alternative B. The parking structure for the Fox 19 television station at 635 West 7<sup>th</sup> Street is within the construction limits of Alternative G. The parking that would be lost would be mitigated, resulting in no negative impact to this resource, both as a business and as a historic site.

#### **4.2.9 Environmental Justice**

Overall, impacts to environmental justice populations would be the same for all conceptual alternatives within Kentucky. Impacts to low-income populations (displacements) are not of a greater number than non-low-income populations within Kentucky and are not expected to be high and disproportionate. Low-income population displacements would account for approximately four percent of the total displacements in Kentucky. These three displacements are applicable to all conceptual alternatives. Because there are potential displacements to low-income residents, Last Resort Housing may be necessary. None of the displacements are within Census tracts of high minority populations for any alternative and are not expected to be high and disproportionate. Displacements of residences and businesses are also discussed in Section 4.2.7.

The displacement of potentially low-income residents occurs within the Lewisburg neighborhood for all alternatives. Community cohesion could be impacted in this neighborhood and historic district through the loss of residences.

Goebel Park, a community facility in a Census tract with a high percentage low-income population, would be positively and negatively impacted by all conceptual alternatives. Right of way is required from Goebel Park by all conceptual alternatives, which is a negative impact to the park. However, mitigation measures in exchange for the land could enhance the park facilities. The total amount of acreage and facilities impacted at this park by alternative are discussed in Section 4.2.3.1. No other community resources and facilities within all alternative impact limits are within areas with a high percentage of environmental justice populations.

The study area within Ohio shows a high percentage of low-income populations. Any impacts resulting from this project (displacements, loss of community resources, and changes in access) would have an impact on these populations and therefore would not be disproportionate. In Ohio, potential displacements would occur in Census tracts with a high percentage of minority and low-income populations. All alternatives will have an impact on environmental justice populations. Alternatives E and G would impact a residential and industrial property on York Street in the West End, near Western Avenue. The residence is expected to be able to relocate within the area. The Census tracts where this residential impact would occur have a 36.7 percent vacancy rate (US Census 2000). Alternatives B, C, D, E, and G would impact residential property on Central Parkway where 12.2 percent of properties are vacant. It is expected that residences would be able to relocate in the area.

Businesses are expected to be displaced within environmental justice populations of the West End neighborhood and Queensgate area. The businesses near the Western Hills Viaduct include a gas station and restaurant.

The Queensgate playground and ballfields, located in a low-income and minority community, is within the potential impact limits of Alternatives C, D, and G. Similar to Goebel Park in Kentucky, the impacts to the Queensgate playground and ballfields are negative but the resulting mitigation measures could enhance the park facilities. Section 4.2.3.1 discusses specific impacts to the Queensgate playground and ball field by alternative.

Access or travel patterns for environmental justice populations are not expected to change for all conceptual alternatives in Ohio. These populations are not expected to have mobility or access changed to community resources. Existing public transit stops should remain at their current locations in these communities and future plans for transit are anticipated to not be precluded.

The No Build Alternative would not result in impacts to environmental justice communities within the study area because any minor, short-term safety and maintenance improvements to the Brent Spence Bridge and I-75 corridor would be within the existing right of way.

#### **4.2.9.1 Joint Development Measures**

Joint development measures, or multiple uses, are those actions taken by different groups aimed at preserving or enhancing an affected community's social, economic, environmental, and visual values. The basic objective is to achieve better compatibility between a highway project and its environment and to obtain maximum benefits from the use of land.

Any programs currently or planned to be put in action that could be impacted by the project should be compensated to remain in action. Agreements between a combination of local, the state, and the private sector can be produced where needed in response to impacts by the proposed conceptual alternatives.

Possible measures that could be used for this project can include, but are not limited to, the following:

- Transit lanes or use of shoulders for bus transit
- Develop land as a new land use or new industrial park in Ohio between the new bridge and local access bridges for Alternative B
- Areas below bridges, such as parking facilities, Riverfront Park, Longworth Hall, etc could be part of airspace leasing provisions
- Implementation of beautification projects adjacent to right of way

### 4.3 Natural Environment

#### 4.3.1 Aquatic Resources

Aquatic resources in the study area are limited to the Ohio River, seven intermittent streams, four ephemeral streams, and one open water pond, all of which are located in Kentucky. The streams are highly disturbed and rate in the lowest quality category of “not supporting” its designated use. The physical characteristics of intermittent streams identified in the study area were documented along with a habitat assessment of each intermittent stream using the US Environmental Protection Agency’s 1999 *Rapid Bioassessment Protocols for Use in Wadeable Streams and Rivers* (RBP). Full descriptions of aquatic resources are discussed in the *Ecological Survey Report (KYTC Project Item No. 6-17)* (February 2007) and *Level One Ecological Survey Report (ODOT PID No. 75119)* (February 2007).

Only three streams, two intermittent and one ephemeral would be impacted by the conceptual alternatives (Exhibit 15A – 15D). These streams are located immediately adjacent to the I-71/I-75 corridor and would be impacted by widening the interstate. The impacts would be the same for all conceptual alternatives. Table 25. provides a summary of the streams, their aquatic resource RBP rankings and impacts.

**Table 25. Stream Impacts**

Stream ID	RBP Rating and Use Designation	Stream Length in Study Area (linear feet)	Alternatives B, C, D, E, and G Stream Impacts (linear feet)
Intermittent 1	143 – partially supporting	1,225	0
Intermittent 2	132 –not supporting	530	0
Intermittent 3	107 – not supporting	265	0
Intermittent 4	158 – fully supporting	2,375	0
Intermittent 5	95 – not supporting	960	30
Intermittent 6	152 – supporting	685	0
Intermittent 7	127 – not supporting	660	177
<b>Total</b>		<b>6,700</b>	<b>207</b>
Ephemeral 1	NA	245	245
Ephemeral 2	NA	315	0

**Table 25. Stream Impacts**

<b>Stream ID</b>	<b>RBP Rating and Use Designation</b>	<b>Stream Length in Study Area (linear feet)</b>	<b>Alternatives B, C, D, E, and G Stream Impacts (linear feet)</b>
Ephemeral 3	NA	220	0
Ephemeral 4	NA	195	0
<b>Total</b>		<b>975</b>	<b>245</b>

Source: *Ecological Survey Report (KYTC Project Item No. 6-17) (February 2007)*  
*Level One Ecological Survey Report (ODOT PID No. 75119) (February 2007)*

The Ohio River is approximately 1,300 feet wide at the location of the existing Brent Spence Bridge. The normal pool elevation of the river in this location is approximately 455 feet above mean sea level and the ordinary high water mark is about 468.5 feet above mean sea level. New bridge crossings of the Ohio River are proposed at one of two locations.

Alternative B would cross the Ohio River on a new bridge approximately 900 feet west of the existing Brent Spence Bridge. Pier locations for the bridge were determined through coordination with the US Coast Guard (USCG). In Kentucky, one pier would be located on the bank of the Ohio River between the existing floodwall wall and the waters edge. In Ohio, the pier would be located on the bank of the Ohio River approximately 1,650 feet north of the southern pier. It is anticipated that less than 10 percent of either pier would be located within the Ohio River due to the skew angle of the bridge, the bend in the Ohio River at this location and the size of the piers. The bridge abutments would be located 650 feet north and south of the proposed piers.

Alternatives C, D, E, and G would cross the Ohio River on a new bridge located approximately 120 feet west of the existing Brent Spence Bridge. In accordance with USCG requirements, the piers for this bridge must be placed "outside" of the existing Brent Spence Bridge piers. The piers would be placed in the Ohio River approximately 35 feet closer to the banks of the Ohio River than the current Brent Spence Bridge piers. The existing Brent Spence Bridge has a middle span length of 830.5 feet between existing piers. The new bridge would have a middle span length of 900 feet from center to center of the proposed piers. The bridge abutments would be located 400 feet north and south of the proposed piers.

The No Build Alternative would not impact streams or the Ohio River within the study area because any minor, short-term safety and maintenance improvements to the Brent Spence Bridge and I-75 corridor would be within the existing right of way.

#### **4.3.2 Wetlands**

There are eight wetlands in the Kentucky portion of the study area, which total 1.98 acres. There are no wetlands in the Ohio portion of the study area. Only three wetlands, two jurisdictional and one isolated would be impacted by the conceptual alternatives (Exhibit 15A – 15B). These wetlands are located adjacent to the west side of the I-71/I-75 corridor north of the Kyles Lane Interchange. They would be impacted by widening the interstate and the impacts would be the same for all conceptual alternatives. The No Build Alternative would not impact wetlands within the study area because any minor, short-term safety and maintenance improvements to the Brent

Spence Bridge and I-75 corridor would be within the existing right of way. Table 26. provides a summary of the wetlands and impacts.

**Table 26. Wetland Impacts**

Wetland Number	Hydrology	Acreage in Study Area	Alternatives B, C, D, E, and G Wetland Impacts (acres)
1	Isolated	0.03	0
2	Non-isolated	0.02	0
3	Non-isolated	0.90	0
4	Non-isolated	0.28	0
5	Isolated	0.14	0.14
6	Non-isolated	0.05	0.05
7	Isolated	0.16	0
8	Non-isolated	0.40	0.40
<b>Total</b>		<b>1.98</b>	<b>0.59</b>
Total Isolated		0.33	0.14
Total Non-Isolated		1.65	0.45

\* Wetlands have not been verified by the USACE  
Source: *Ecological Survey Report (KYTC Project Item No. 6-17) (Feb. 2007)*  
Level One Ecological Survey Report (ODOT PID No. 75119) (Feb. 2007)

#### **4.3.3 Terrestrial Resources**

The majority of the study area is occupied by intensively developed urban land, including commercial, residential, and industrial uses (Exhibit 15A – 15D). Additionally, transportation roadways (e.g., highways, streets, railways) and maintained lawn are also present. In Kentucky, terrestrial habitats are also urban in nature but have a mixed age woods component that has not been cleared in the past 30 to 40 years. Woodlots are located adjacent to the interstate and the Ohio River. In Ohio, terrestrial habitats are limited to a narrow, wooded riparian zone consisting of young trees and shrubs located along portions of the Ohio River and scrub shrub areas along the existing interstate right of way. Impacts to terrestrial habitat would result from widening the interstate in Kentucky and constructing a new bridge across the Ohio River. Terrestrial habitat impacts would be similar for the conceptual alternatives, Alternative B would impact 11 woodlots and Alternatives C, D, E, and G would impact 10 woodlots. The No Build Alternative would not impact terrestrial habitat within the study area because any minor, short-term safety and maintenance improvements to the Brent Spence Bridge and I-75 corridor would be within the existing right of way.

#### **4.3.4 Threatened and Endangered Species**

The study area lies within the ranges of several federal and state-listed species. However, there are no documented populations of threatened and endangered species or critical habitat within the study area. Threatened and endangered species habitat surveys conducted in 2006 identified several areas in Kentucky that could provide habitat for running buffalo clover and the Indiana Bat. Potential habitat areas for running buffalo clover and the Indiana Bat were not identified in Ohio.

The surveys identified one area in Kentucky adjacent to the west side of the I-71/I-75 corridor as potential running buffalo clover habitat, but did not locate any populations of the plant. Running buffalo clover can be found in partially shaded woodlots, mowed

areas (lawns, parks, cemeteries), and along streams and trails within rich woods. It requires periodic disturbance and somewhat open habitat to successfully flourish, but cannot tolerate full-sun, full-shade, heavy invasive species growth, or severe disturbance. Impacts to the one area of potential running buffalo clover habitat would result from widening the interstate in Kentucky. Habitat impacts would be similar for all the conceptual alternatives.

Indiana bat habitat throughout the study area was categorized as potential Indiana bat habitat and marginal Indiana bat habitat. Potential habitat consists of the mixed-age woods, which exhibit large tree stands with characteristics most favorable for potential Indiana bat habitat. Marginal habitat consists of single-family residential developments with scattered individual mature trees and young woods. Habitat areas are located adjacent to the east and west sides of the I-71/I-75 corridor. Impacts to Indiana bat habitat would result from widening the interstate in Kentucky and constructing a new bridge across the Ohio River. Alternative B would impact eight woodlots with potential Indiana bat habitat and three woodlots with marginal Indiana bat habitat. Alternatives C, D, E, and G would impact eight woodlots with potential Indiana bat habitat and two woodlots with marginal Indiana bat habitat.

The habitat surveys conducted in 2006 identified areas in Ohio that could provide habitat for several species. Habitat for Kirkland's snake includes urban backyards, which are located in the northern portion of the study area. The narrow wooded riparian area along the Ohio River may provide marginal habitat for the Black-crowned Night Heron. Marginal habitat for riverbank paspalum is limited to portions of the Ohio River Bank that will not be impacted by the conceptual alternatives. Habitat for Virginia mallow is potentially present along the bank of the Ohio River in areas of loose, sandy soil. Habitat for the smooth buttonweed was not identified in the study area.

The No Build Alternative would not impact endangered or threatened species within the study area because any minor, short-term safety and maintenance improvements to the Brent Spence Bridge and I-75 corridor would be within the existing right of way.

#### **4.4 Cultural Resources**

In Kentucky there are five historic resources listed on the National Register of Historic Places (NRHP) and 11 properties determined potentially eligible for the NRHP within or in close proximity to the area of potential effects (APE) (see Table 8 and Exhibit 16A). In Ohio there are three individual properties and two historic districts listed on the NRHP within the APE. There are also three properties determined eligible for listing and one property potentially eligible for listing on the NRHP within the APE (see Table 9 and Exhibit 16B). Six of the 25 historic resources would be affected by the five conceptual alternatives. Table 27 identifies the six affected historic resources, the impacts of the alternatives, and preliminary determinations of effect. The determinations of effect for the resources will be finalized in Step 6. The No Build Alternative would not impact historic resources within the study area because any minor, short-term safety and maintenance improvements to the Brent Spence Bridge and I-75 corridor would be within the existing right of way.

**Table 27. Historic Resources Impacts**

Resource Number	Name	National Register Status	Alternative Impacts	Preliminary Determination of Effect
NRHP No. 93001165	Lewisburg Historic District	NRHP 1993	Alternative B 2.4 acres and 8 displacements (1 non-contributing and 7 contributing properties) Alternative C 0.83 acres and 10 displacements (1 non-contributing and 9 contributing properties) Alternative D 0.88 acres and 10 displacements (1 non-contributing and 9 contributing properties) Alternative E 0.98 acres and 11 displacement (1 non-contributing and 10 contributing properties) Alternative G 2.9 acres and 12 displacements (2 non-contributing and 10 contributing properties)	Adverse Effect
KECL 1018	Residence at 521 Western Avenue, Covington	Eligible 2008	Alternative B Potential visual and noise impacts due to the close proximity of the alternative.	No Adverse Effect
HAM-1342-43	Harriet Beecher Stowe Elementary School (Fox 19 Television Station)	Eligible 2008	Alternatives C, D, E and G Potential visual and noise impacts due to the close proximity of the alternatives.	No Adverse Effect
HAM-1656-43 NRHP No. 86003521	Longworth Hall (Baltimore Ohio RR – Freight)	NRHP 1986	Alternative C 0.25 acres Alternative D 0.25 acres Alternative E 0.54 acres Alternative G 0.42 acres	Adverse Effect
KEC 460	Residence at 881 Highway Avenue	Potentially Eligible 2009	Alternative B Potential visual and noise impacts due to the close proximity of the alternative.	No Adverse Effect
KECL 1046	Residence at 632 Western Avenue	Potentially Eligible 2009	Alternative B displacement of residence and property impacts.	Adverse Effect

The Lewisburg Historic District is expected to be adversely effected by the widening of the interstate by all conceptual alternatives. The alternatives would encroach upon the historic boundary along its eastern border and displace 8 to 12 residences on KY 11<sup>th</sup> and KY 12<sup>th</sup> streets and Crescent Avenue adjacent to the west side of I-71/I-75. There are ten contributing residences and two non-contributing residences within the construction limits of the alternatives in the Lewisburg Historic District (Table 28).

**Table 28. Lewisburg Historic District Properties within Impact Limits**

<b>Property Address</b>	<b>Contributing/Non-Contributing</b>	<b>Alternative Impact</b>
806-08 Crescent Avenue	Contributing	B, C, D, E, G
812 Crescent Avenue	Contributing	B, C, D, E, G
822 Crescent Avenue	Contributing	B, C, D, E, G
824 Crescent Avenue	Contributing	B, C, D, E, G
816 Crescent Avenue	Contributing	C, D, E, G
818 Crescent Avenue	Contributing	C, D, E, G
820 Crescent Avenue	Contributing	E, G
834 Crescent Avenue	Non-Contributing	B, C, D, E, G
605 11 <sup>th</sup> Street	Contributing	B, C, D, E, G
606 11 <sup>th</sup> Street	Contributing	B, C, D, E, G
604 12 <sup>th</sup> Street	Contributing	B, C, D, E, G
729 Crescent Avenue	Non-Contributing	G

The residence at 521 Western Avenue would not be directly impacted by any of the conceptual alternatives. The historic boundary of the residence at 521 Western Avenue includes the full rectangular shaped parcel, which fronts Western Avenue for 92 feet. The proposed right of way limits for the alternatives would not encroach upon the property but would be located within close proximity to this historic resource. Alternative B would be located within 15 feet of the property, the closest of the five alternatives to the resource. The other conceptual alternatives would be further away from this resource. It is expected that Alternative B would not have an adverse effect on this resource.

The residence at 632 Western Avenue would be displaced by Alternative B. This alternative is expected to have an adverse effect on this resource. Alternatives C, D, E, and G would not impact this property.

The residence at 881 Highway Avenue would not be directly impacted by any of the conceptual alternatives. The impact limits of Alternative B are located approximately 275 feet from this resource. Alternative B could have visual and noise impacts to this property due to the close proximity of the alternative. It is expected that Alternative B would not have an adverse effect on this resource. Alternatives C, D, E, and G would not impact this property.

The historic boundary for the Harriet Beecher Stowe Elementary School (Fox 19 Television Station) follows the footprint of the school building. Alternatives B, C, D, and E would be located within the existing right of way limits of I-75 located to the north and east of the school property. At the closest point, the alternatives would be within 16 feet of the school building, which is the same distance as the existing road network. Alternative G would also be located within the existing right of way limits of I-75 located to the north and east of the school property. This alternative proposes a ramp that would cross over the northeast corner of the parking structure. If the parking structure were to be displaced by Alternative G, it could be mitigated, resulting in no negative impacts to this resource. The potential impacts of the conceptual alternatives include visual and noise due to the close proximity of the alignments to this resource. It is expected that Alternatives C, D, E, and G would not have an adverse effect on this resource, while Alternative B would have no effect on this resource.



Longworth Hall would be directly impacted by Alternatives C, D, E, and G. These four alternatives are expected to have an adverse effect on this resource. The conceptual alternatives would encroach upon the historic boundary and pass through the eastern end of the building. The eastern end of the building would be demolished. Alternatives C and D would have the least amount of impact on the building and historic boundary, requiring only 0.25 acres. Alternatives E and G would impact 0.54 and 0.42 acres, respectively of this resource including the building and historic boundary. Alternative B would be located adjacent to the historic boundary of Longworth Hall and within 37 feet of the west end of the building. Alternative B is expected to have no effect on Longworth Hall.

#### 4.5 Hazardous Materials

A total of 57 properties within or adjacent to the construction limits of the conceptual alternatives are recommended for Phase I Environmental Site Assessments (ESA) (Exhibit 18A – 18C). Fifteen of the 57 properties are located in Kentucky and 42 are located in Ohio. Many of these 57 hazardous material sites are comprised of multiple parcels of property. Therefore impacts for one site often involve multiple parcels. The impact assessment for hazardous materials presented in Table 29 reflects the number of sites recommended for Phase I ESA rather than the total number of property parcels which comprise each site.

**Table 29. Sites Recommended for Phase I Environmental Site Assessments**

Site Description	Alternatives				
	B	C	D	E	G
	Within/Adjacent*	Within/Adjacent	Within/Adjacent	Within/Adjacent	Within/Adjacent
<b>Kentucky</b>					
Gas Station	3/6	3/4	3/4	0/7	3/5
Auto Repair or Dealership	2/0	2/0	2/0	2/0	2/0
Machine Shop	1/0	1/0	1/0	1/0	1/0
Heating/Air Conditioning Company	0/0	1/0	1/0	1/0	1/0
Convenience Store	1/0	1/0	1/0	1/0	1/0
Dry Cleaner	1/0	0/0	0/0	0/0	0/0
<b>Ohio</b>					
Gas Station	12/1	3/0	8/0	7/1	8/1
Convenience Store					
Junkyard	3/0	0	0	0	0
Scrap Metal Company	1/0	0	0	0	0
Transformer Yard	1/0	1/0	1/0	1/0	1/0
Janitorial Supply Company	1/0	1/0	1/0	1/0	1/0

**Table 29. Sites Recommended for Phase I Environmental Site Assessments**

Site Description	Alternatives				
	B	C	D	E	G
Chemical Company	1/0	1/0	1/0	1/0	1/0
Manufacturing Companies	0/1	0/1	0/1	0/1	0/1
Brewery	1/0	0	0	0	0
Butternut Bread Company	1/0	0	0	0	0
Cinergy; Cincinnati Gas and Electric Facilities	1/0	2/0	2/0	2/0	2/0
United Parcel Service	1/0	0	0	0	0
City of Cincinnati Services	2/0	2/0	2/0	2/0	2/0
Furniture Company	1/0	1/0	1/0	1/0	1/0
West Virginia Coal and Coke Company	1/0	0	0	0	0
Valley Asphalt	0/1	1/0	1/0	1/0	1/0
Standard Marble Works	1/0	0	0	0	0
Sheet Metal	0/1	0/1	0/1	0/1	0/1
Auto Dealership	1/0	0	0	0	0
ADP, Inc.	0/1	0/1	0/1	0/1	0/1
Laundry	0/1	0	0	0	0
Sanitation	1/0	1/0	1/0	1/0	1/0
Hydraulics	1/0	1/0	1/0	1/0	1/0
CERCLIS Site	1/0	0/0	0/0	0/0	0/0
<i>Total Sites in Kentucky</i>	<i>8/6</i>	<i>8/4</i>	<i>8/4</i>	<i>5/7</i>	<i>8/5</i>
<i>Total Sites in Ohio</i>	<i>31/6</i>	<i>14/3</i>	<i>19/3</i>	<i>18/4</i>	<i>19/4</i>
<b>Total Number of Sites</b>	<b>39/12</b>	<b>22/7</b>	<b>27/7</b>	<b>23/11</b>	<b>27/9</b>

Note: \*Within/Adjacent is the number of sites within or adjacent to the construction limits of the conceptual alternative recommended for Phase I ESAs.

Alternative B has a total of 52 sites within and adjacent to its construction limits, which require Phase I ESAs. Alternatives D and E have a total of 34 sites within and adjacent to their construction limits, which require Phase I ESAs. Alternatives C and G have a total of 29 and 36 sites, respectively within and adjacent to their construction limits, which require Phase I ESAs. In the next phase of the project, the number of sites

recommended for Phase I ESAs may be reduced because several sites are located within existing right of way where roadway construction has occurred. These sites are included in the number of sites recommended for Phase I ESAs.

## **4.6 Visual Quality**

### **4.6.1 Bridge Structure and River Crossing Zone**

The impact of a new bridge over the Ohio River and the project corridor will be considered in terms of visual and aesthetic quality. The design of a new bridge will impact the view of the Ohio River from the north and south sides of the river and from the roadway network. The alternatives will have a relatively equal impact on the aesthetic quality in terms of the interstate mainline bridges. A new bridge, no matter the alternative, will be designed with input from an aesthetics committee that has been assembled for this project to address visual issues and to produce context sensitive solutions for the bridge structure and the entire I-71/I-75 corridor. This committee will help produce ways to maximize positive views of the new bridge within economic limits and seek to maximize aesthetic appeal throughout the I-71/I-75 corridor. The committee will consider context sensitive design to maximize visual quality of the corridor.

Alternative B proposes a new Ohio River bridge closer to residential areas within Kentucky which could potentially impact the existing view. The new bridge for I-75 in Alternative B would change the view across the Ohio River. Public comments have expressed concern that the new Ohio River bridge proposed by Alternative B could detract from the view of the corridor. According to public comment, a higher bridge elevation would negatively impact the view, especially residential, from Kentucky over to Ohio. A double-deck bridge will be a higher structure than the existing bridge that would also require higher elevations for ramps. The bridges proposed for Alternatives C, D, E, and G would also affect the view over the Ohio River with the addition of a structure or larger structure in close proximity to the existing bridge.

The view from the motorist's perspective while driving across the bridge would be impacted based on whether a double-deck or single-deck bridge is used. The driver's view will also be impacted by the number of bridges. Alternatives C, D, E, and G would have views from a double-deck bridge.

### **4.6.2 Ohio and Kentucky Corridor Zones**

Trees and any landscaping adjacent to the existing right of way may potentially be removed. In both Ohio and Kentucky, more trees are expected to be removed by Alternative B than by Alternatives C, D, E, and G because Alternative B being partially on new alignment and requires more right of way.

The No Build Alternative would not impact the visual quality of the study area because any minor, short-term safety and maintenance improvements to the Brent Spence Bridge and I-75 corridor would be within the existing right of way. There would not be any changes to the interstate corridor that would change the aesthetic quality of the area.

## **4.7 Transportation**

### **4.7.1 Pedestrian and Bicycle Facilities**

Due to the type of roadway for the proposed project, no pedestrian or bicycle facilities will be accommodated by the No Build or conceptual alternatives. There are currently no designated bike paths in the study area within Ohio. A bicycle path in Cincinnati is planned along the Riverfront following Mehring Way as part of the Cincinnati Riverfront Park plan. This proposed path would not be affected by any of the conceptual alternatives. Within Kentucky, a pedestrian and bicycle trail is located in Goebel Park. Proposed bike paths in Kentucky, along KY 3rd Street and Pike Street, have the potential to be impacted by Alternative B. Alternatives C, D, E, and G are not expected to impact locations of proposed bike paths.

### **4.7.2 Transit**

All conceptual alternatives would potentially impact public transportation schedules during construction since express routes utilize the interstate. Construction would result in detours and delays by all conceptual alternatives.

There would be potential temporary impacts during construction to Transit Authority of Northern Kentucky (TANK) routes and stops, specifically to the Southbank Shuttle route that operates between Cincinnati and Kentucky. The Southbank Shuttle has stops located within the impact limits of the alternatives on: KY 3rd Street (Holiday Inn); Crescent Avenue (Willies Sports Café and across street from Hampton Inn); and KY 5th Street (Radisson Hotel at end of ramp at Goebel Park). The KY 3rd Street and Crescent Avenue stops are within the limits of Alternative B. The KY 5<sup>th</sup> Street stop is within impact area of all alternatives however, impacts are not expected since the stop is within existing right of way.

No other TANK bus stops will be impacted by any of the conceptual alternatives. Several express routes use I-71/I-75 throughout the project corridor. Travel times may be impacted by the maintenance of traffic during construction.

The following Southwest Ohio Regional Transit Authority (SORTA) routes and bus stops have a potential to be impacted by the conceptual alternatives.

- Bus 27 stops at Central Avenue and OH 3rd Street are within the impact limits of all conceptual alternatives.
- Bus 85 has stops on Pete Rose Way underneath I-71/I-75. All conceptual alternatives may have an impact during construction since work will be done on the bridge but will not change the road itself.
- Buses 10, 32, 33, 50 could be impacted on OH 8<sup>th</sup> Street during construction by Alternative B for construction of the additional bridge. One express route each on OH 8<sup>th</sup> Street and OH 6<sup>th</sup> Street pass through the study area, but no stops are made in the Queensgate area.

SORTA also has a primary bus garage and maintenance facility at Bank and Dalton streets. The garage is not within the construction limits of any alternative.

The No Build Alternative would not affect transit services in the study area because any minor, short-term safety and maintenance improvements to the Brent Spence Bridge and I-75 corridor would be within the existing right of way.

None of the conceptual alternatives or the No Build Alternative will preclude future plans for modal alternatives, such as the Regional Rail Plan, that have been identified for the region and are in the current Ohio Kentucky Indiana Transportation Plan. High occupancy vehicle (HOV) lanes, which can be utilized by bus rapid transit, will be investigated in future steps, if warranted by capacity analysis. No additional plans will be made for alternative modes through this project as it is outside of the scope.

Planning for transit was done in the *North-South Transportation Initiative*. As shown in cross sections and Exhibits 4 through 10, the planned regional light rail line would be accommodated south of the Ohio River (south of KY 12<sup>th</sup> Street) and north of Western Hills Viaduct. Each of the conceptual alternatives has been designed to not preclude light rail in the future as identified in the rail plan. Plans for a future light rail system would use the Clay Wade Bailey Bridge to cross the river and not the Brent Spence Bridge.

A future bus system that would be accommodated along the corridor would allow for buses to use shoulders. Both SORTA and TANK support this type of system along the corridor. SORTA does not currently have plans to implement a bus on shoulder program on I-75. However, all of the conceptual alternatives are to be able to accommodate a future system since shoulders must conform to ODOT standards. TANK passed a resolution in 2006 that supports including bus shoulder lanes in the design of alternatives.

#### **4.8 Section 4(f) and 6(f) Resources**

There are a total of 31 Section 4(f) resources within the study area. Nineteen of the 25 resources are located in Kentucky and 12 are located in Ohio. Two parks, Devou Park and Goebel Park in Covington, Kentucky are Section 6(f) resources. Alternatives B, C, D, and G would impact five Section 4(f) resources and Alternative E would impact four Section 4(f) resources (Table 30 and Exhibit 17A – 17B). A preliminary determination of the Section 4(f) documentation required for each impacted resource is listed in Table 30. All of the conceptual build alternatives would directly impact Goebel Park, a Section 6(f) resource. The No Build Alternative would not impact Section 4(f) resources within the study area because any minor, short-term safety and maintenance improvements to the Brent Spence Bridge and I-75 corridor would be within the existing right of way.

**Table 30. Section 4(f) Resource Impacts**

<b>Resource</b>	<b>Description</b>	<b>Alternatives Impacts</b>	<b>Preliminary Section 4(f) Documentation</b>
Goebel Park including Pool Complex and Kenney Shields Park	Park area; city gardens at KY 5 <sup>th</sup> Street; basketball courts at KY 9 <sup>th</sup> Street; passive areas; picnic shelters; tot lots; swimming pool; playground equipment; walking paths	Alternative B 1.86 acres Alternative C 2.6 acres Alternative D 1.94 acres Alternative E 0.35 acres Alternative G 0.78 acres	<i>De minimis</i> Finding
Lewisburg Historic District	The district includes 700 acres, 430 buildings, and 48 non-contributing buildings. Most of the buildings were constructed in the 1870's and 1880's; Listed in the NRHP in 1993	Alternative B 2.4 acres and 8 displacements (1 non-contributing and 7 contributing properties) Alternative C 0.83 acres and 10 displacements (1 non-contributing and 9 contributing properties) Alternative D 0.88 acres and 10 displacements (1 non-contributing and 9 contributing properties) Alternative E 0.98 acres and 11 displacement (1 non-contributing and 10 contributing properties) Alternative G 2.9 acres and 12 displacements (2 non-contributing and 10 contributing properties)	Individual Evaluation
Residence at 521 Western Avenue, Covington	Residence constructed in 1870; Recommended as eligible for listing in the NRHP in 2008	Alternatives B Potential visual and noise impacts due to the close proximity of the alternative.	<i>De minimis</i> Finding
Harriet Beecher Stowe Elementary School (Stowe Adult Education Center)	Constructed in 1923; Recommended as eligible for listing in the NRHP in 2008	Alternatives C, D, E, and G Potential visual, noise and vibration impacts due to the close proximity of the alternative	<i>De minimis</i> Finding
Longworth Hall (Baltimore Ohio RR –Freight)	1904/Rehabilitated; Listed in the NRHP in 1986	Alternative C 0.25 acres Alternative D 0.25 acres Alternative E 0.54 acres Alternative G 0.42 acres	Individual Evaluation
Queensgate Playground and Ballfields	Playground equipment, baseball fields and football field	Alternative C 0.31 acres Alternative D 0.45 acres Alternative G 0.29 acres	<i>De minimis</i> Finding
Residence at 881 Highway Avenue, Covington	Constructed ca. 1870; Recommended as eligible for listing in the NRHP in 2009	Alternative B Potential visual and noise impacts due to the close proximity of the alternative.	<i>De minimis</i> Finding

**Table 30. Section 4(f) Resource Impacts**

Resource	Description	Alternatives Impacts	Preliminary Section 4(f) Documentation
Residence at 632 Western Avenue, Covington	Constructed ca. 1920; Recommended as potentially eligible for listing in the NRHP in 2009	Alternative B displacement of residence and property impacts.	Individual Evaluation

Goebel Park would be impacted by the widening of the interstate by all proposed conceptual alternatives. Alternatives B, C, and D would each impact a parking lot, basketball courts, and walking path located on the west side of the park adjacent to the interstate. Alternative G would impact the same parking lot and basketball courts as Alternatives B, C, and D. Alternative E would impact only a small area of land 0.35 acres adjacent to the interstate. A neighborhood pool, located in Goebel Park is not expected to be directly impacted by any of the alternatives.

The Lewisburg Historic District would be impacted by the widening of the interstate by all proposed conceptual alternatives. The alternatives would encroach upon the historic boundary along its eastern border and displace 8 to 12 residences on 11<sup>th</sup> and 12<sup>th</sup> streets and Crescent Avenue adjacent to the west side of I-71/I-75. There are ten contributing residences and two non-contributing residences within the construction limits of the conceptual alternatives in the Lewisburg Historic District (Table 28). Alternative B would impact 2.4 acres of the historic district and displace eight residences, one of which is a non-contributing property to the historic district. Seven properties are contributing resources to the historic district. Alternative C would impact 0.83 acres and displace 10 residences. Of the 10 residences, one is a non-contributing property and nine are contributing resources to the historic district. Alternative D would impact 0.88 acres and displace 10 residences, one of which is a non-contributing property to the historic district. Nine properties are contributing resources to the historic district. Alternative E would impact 0.98 acres and displace 11 residences. Of the 11 residences, one is a non-contributing property and 10 are contributing resources to the historic district. Alternative G would impact 2.9 acres and displace 12 residences. Of the 12 residences, two are non-contributing properties and 10 are contributing resources to the historic district.

The residence at 521 Western Avenue would not be directly impacted by any of the conceptual build alternatives (Exhibit 16D). The historic boundary of the residence at 521 Western Avenue includes the full rectangular shaped parcel, which fronts Western Avenue for 92 feet. The proposed right of way limits for the alternatives would not encroach upon the property but would be located within close proximity to this historic resource. Alternative B would be located within 15 feet of the property. The other conceptual alternatives would be further away from this resource. Alternative B could have potential impacts to this resource which include visual, noise and vibration due to the close proximity of the alignment to this resource. Visual and noise studies will be completed in future stages of the project to determine if impacts will result from any of the alternatives.

The residence at 632 Western Avenue would be potentially displaced by Alternative B. Alternatives C, D, E, and G would no effect on this resource.

The residence at 881 Highway Avenue would not be directly impacted by any of the conceptual alternatives. The impact limits of Alternative B are located approximately 275 feet from this resource. Alternative B could have visual and noise impacts to this property due to the close proximity of the alternative. It is expected that Alternative B would not have an adverse effect on this resource. Visual and noise studies will be completed in future stages of the project to determine impacts. Alternatives C, D, E, and G would not impact this property.

The historic boundary for the Harriet Beecher Stowe Elementary School (Fox 19 Television Station) follows the footprint of the school building. Alternatives B, C, D, and E would be located within the existing right of way limits of I-75 located to the north and east of the school property. At the closest point, the alternatives would be within 16 feet of the school building, which is the same distance as the existing road network. Alternative G would also be located within the existing right of way limits of I-75 located to the north and east of the school property. This alternative proposes a ramp that would cross over the northeast corner of the parking structure. If the parking structure were to be displaced by Alternative G, it could be mitigated, resulting in no negative impacts to this resource. The potential impacts of the conceptual alternatives include visual and noise due to the close proximity of the alignments to this resource. It is expected that Alternatives C, D, E, and G would not have an adverse effect on this resource, while Alternative B would have no effect on this resource. Visual and noise studies will be completed in future stages of the project to determine if impacts will result from any of the alternatives.

Longworth Hall would be directly impacted by Alternatives C, D, E, and G. These four conceptual alternatives would encroach upon the historic boundary and pass through the eastern end of the building. The eastern end of the building would be demolished. Alternatives C and D would impact 0.25 acres of this resource including the building and historic boundary. Alternatives E and G would impact 0.54 and 0.42 acres, respectively of this resource including the building and historic boundary. Alternative B is the only alternative that would not directly impact Longworth Hall. Alternative B would be located adjacent to the historic boundary of Longworth Hall and within 37 feet of the west end of the building.

The Queensgate playground and ball fields would be impacted by Alternatives C, D, and G. The proposed construction limits for the alternatives would encroach upon the western edge of the property adjacent to I-75 resulting in a sliver take of the property. Alternative D would require 0.45 acres from the park. Alternatives C and G would impact only a small area of land totaling 0.31 and 0.29 acres, respectively adjacent to the interstate. These two Alternatives B and E would not impact the Queensgate playground and ball fields.

#### **4.9 Noise**

A noise analysis is required for Brent Spence Bridge Replacement/Rehabilitation Project, because of the project's proposed alteration of an existing highway, which includes a substantial change in alignment and the addition of capacity. A noise analysis must be conducted to determine what noise impacts, if any, will result from the proposed highway improvements. If noise impacts are expected, noise reduction measures that are determined to be practicable, reasonable, and acceptable to the



affected public, must be incorporated into the highway improvement and are eligible for federal funding in the same proportion as other aspects of the project.

In Step 5 of ODOT's Project Development Process (PDP), current and potentially impacted areas associated with the conceptual alternatives must be identified and abatement costs must be estimated. If no potentially impacted receptors are identified, the noise analysis process is complete. However, if potentially impacted receptors are identified, a preliminary noise analysis of feasible alternatives and a cost reasonableness screening will be conducted as part Step 6 of the PDP and presented in a Preliminary Noise Analysis Report. This would be followed by a Final Noise Analysis Report to be completed in Step 8 that would include a detailed noise analysis of the Preferred Alternative.

Noise level projections were conducted for 103 noise receptor locations (55 in Kentucky and 48 in Ohio) along the I-71/I-75 corridor and major local routes that would be affected by the conceptual alternatives (Exhibit 19A – 19B). The Federal Highway's (FHWA's) Traffic Noise Model (TNM version 2.5) was used for the projections. The noise levels represent 2008 existing conditions and future design year 2035 conditions for the No Build Alternative and for each of the five conceptual alternatives. The noise level projections are presented in Table 31 and Table 32. Some receptor locations were unable to become validated from the TNM 2.5 noise model and therefore, were given an "n/a" abbreviation. A detailed noise analysis is presented in the *Noise Screening Report (February 2009)*.

A noise impact occurs when the predicted noise level at a receptor approaches or exceeds the FHWA noise abatement criteria (NAC), or when the difference between existing and future noise levels is considered a substantial increase. Both KYTC and ODOT define "approach" as being within one dBA of the NAC; all properties covered by NAC B (generally residential) that have a calculated Leq value of 66 dBA or higher would "approach or exceed" the 67 dBA NAC B criterion. All properties covered by NAC C (commercial, industrial, and manufacturing) with a Leq value of 71 dBA or higher would "approach or exceed" the 72 dBA NAC C criterion. Therefore, Leq values of 66 dBA for NAC B, and 71 dBA for NAC C were used as the threshold values to assess noise impacts. A predicted traffic noise level of 10 dBA or more above the existing noise level constitutes a "substantial" increase according to KYTC's and ODOT's NAC policies.

Table 31 and Table 32 show that existing noise levels in the study area are above the NAC of 66 dBA (Category B) and NAC 71 dBA (Category C). In 2035 the noise levels will increase and the No Build Alternative and conceptual alternatives would have noise impacts in both Kentucky and Ohio (Table 31 and Table 32). Because of these anticipated impacts, a Preliminary Noise Analysis Report will be conducted in Step 6 of ODOT's PDP and a Final Noise Analysis Report will be conducted as part of Step 8.

**Table 31. Projected Noise Levels in Kentucky**

<b>Site # (NAC Category)</b>	<b>2008 Existing (Leq)</b>	<b>2035 No Build (Leq)</b>	<b>2035 Alternative B (Leq)</b>	<b>2035 Alternative C (Leq)</b>	<b>2035 Alternative D (Leq)</b>	<b>2035 Alternative E (Leq)</b>	<b>2035 Alternative G (Leq)</b>
KY-1 (B)	66	76.4	73.9	77.6	77.0	77.4	77.5
KY-2 (B)	69.3	73.8	69.7	74.5	69.3	73.8	74.5
KY-3 (B)	73.2	81.1	83.5	81.3	73.2	81.6	81.6
KY-4 (C)	68.2	70.9	72.1	72.7	72.6	72.7	72.8
KY-5 (B)	65.5	78.1	72.7	78.7	78.5	79	79.2
KY-6 (B)	70.6	80.3	77.1	80.2	79.8	81.1	81.1
KY-7 (B)	67.9	78.2	79.9	80.5	80.2	83.4	83.6
KY-8 (B)	69.7	73.8	n/a	n/a	75.7	74.7	75.9
KY-9 (B)	73.2	73.9	78.6	73.7	73.5	73.9	73.9
KY-10 (B)	58.1	67.3	66	67.6	67.5	67.6	67.6
KY-11 (B)	65.7	75.8	80.6	75.2	74.9	75.4	75.4
KY-12 (B)	59.7	n/a	n/a	n/a	n/a	n/a	n/a
KY-13 (B)	69.7	79.7	78.6	76	75.5	75.9	75.9
KY-14 (B)	68.8	n/a	70.7	70.9	70.6	71.4	71.4
KY-15 (C)	69.4	75.8	76.4	76.7	76.2	76.8	76.8
KY-16 (C)	68.8	76.4	75.1	76.3	75.7	76.8	77.5
KY-17 (C)	70.4	73.4	74.5	74.4	74.3	75.1	72.8
KY-18 (C)	76.3	79.4	80.3	78.5	78.3	78.8	78.8
KY-19 (B)	67.7	70.2	70	68.8	68.4	68.7	68.7
KY-20 (B)	72.6	75.8	76.4	74.6	75.5	75.6	75.6
KY-21 (B)	68.3	72.4	73.4	71.5	72.1	72.2	72.2
KY-22 (B)	77.0	80.0	82.2	79.7	79.3	79.8	79.8
KY-23 (B)	68.7	72.8	72.6	71.9	71.6	72.1	72.1

**Table 31. Projected Noise Levels in Kentucky**

<b>Site # (NAC Category)</b>	<b>2008 Existing (Leq)</b>	<b>2035 No Build (Leq)</b>	<b>2035 Alternative B (Leq)</b>	<b>2035 Alternative C (Leq)</b>	<b>2035 Alternative D (Leq)</b>	<b>2035 Alternative E (Leq)</b>	<b>2035 Alternative G (Leq)</b>
KY-24 (B)	76.7	80.3	82.6	75.7	75.3	75.7	75.7
KY-25 (B)	71.5	74.8	84.8	74.7	74.5	74.9	74.9
KY-26 (B)	70.2	73.2	74.5	73.9	73.4	73.8	73.8
KY-27 (B)	77	80.3	84.6	80.3	80.1	80.5	80.5
KY-28 (B)	79.3	82.7	84.9	83	82.7	83.1	83.1
KY-29 (B)	65.9	68.5	67.8	69.1	68.8	69	69
KY-30 (B)	65.6	68.1	67.7	68.9	68.5	68.7	68.7
KY-31 (B)	81.6	84.6	87.3	84.8	84.7	85	85
KY-32 (B)	67.2	69.9	67.3	70.2	70.1	70.2	70.2
KY-33 (B)	75.7	79.1	80.7	79.2	79	79.4	79.4
KY-34 (B)	75.3	79.2	80.8	79.3	79	79.6	79.6
KY-35 (B)	74.3	78.1	79.5	78.2	77.8	78.5	78.5
KY-36 (B)	68	72.1	72.3	71.8	71.5	73	73
KY-37 (B)	76.7	81.0	83.4	81.1	80.9	81.5	81.5
KY-38 (B)	68.4	72.2	72.9	72.7	72.3	72.8	72.8
KY-39 (B)	75.9	81.3	82.7	82.1	81.7	81.9	81.9
KY-40 (B)	76.1	79.6	76.5	77	76.9	80	80
KY-41 (B)	73.2	77.1	71.8	76.1	75.7	73.2	77.2
KY-42 (B)	71.7	75.6	75.2	74.8	74.1	75.7	76
KY-43 (B)	77.3	81.2	77.2	82.4	81.9	82.3	82.4
KY-44 (B)	70.9	74.7	73	76.5	76.2	76.2	76.6
KY-45 (B)	78.6	82.5	78.6	83.8	83.3	83.5	83.9
KY-46 (B)	74.5	78.1	70.1	79.5	79.6	79.4	79

**Table 31. Projected Noise Levels in Kentucky**

Site # (NAC Category)	2008 Existing (Leq)	2035 No Build (Leq)	2035 Alternative B (Leq)	2035 Alternative C (Leq)	2035 Alternative D (Leq)	2035 Alternative E (Leq)	2035 Alternative G (Leq)
KY-47 (B)	77.4	81.4	n/a	83.6	83.1	83.5	83.5
KY-48 (B)	76	79.8	76.8	80.9	80.5	80.8	80.8
KY-49 (B)	68.7	75	75.9	75.5	74.7	72.8	75.5
KY-50 (B)	71.2	75.8	83.9	77.2	76.7	77.1	77.3
KY-51 (C)	75.7	83.7	77.6	81	80.3	n/a	80.4
KY-52 (C)	69.3	75.6	72.3	73.9	73.5	73.2	73.9
KY-53 (B)	68.8	73.7	76.6	74.2	73.8	73.9	74.9
KY-55 (B)	66.6	73.5	75.6	74.9	74.9	74.7	75.5
KY-56 (B)	68.4	73.9	72.3	71.9	72.4	72.8	72.8

**Table 32. Projected Noise Levels in Ohio**

Site	2008 Existing (Leq)	2035 No Build (Leq)	2035 Alternative B (Leq)	2035 Alternative C (Leq)	2035 Alternative D (Leq)	2035 Alternative E (Leq)	2035 Alternative G (Leq)
OH-1 (B)	69.2	76.5	78.6	77.7	78.2	76.9	77.4
OH-2 (B)	70.1	77.4	78.8	77.9	78.3	77.1	77.5
OH-3 (C)	72.5	n/a	71.4	73.3	72.9	73.4	72
OH-4 (B)	68	78.6	80.1	78.8	78.9	78.6	79.2
OH-5 (B)	72.3	72.5	75.4	74.4	74.6	73.6	74.1
OH-6 (C)	76	77.6	79.6	78.4	78.5	77.5	78
OH-7 (B)	68.8	n/a	74.3	77.4	79.6	76	74.2
OH-8 (B)	71.3	n/a	77	76.7	77.9	76.1	76.7
OH-9 (B)	74	75.4	78.8	78	78.7	77.2	77.7
OH-10 (B)	72.8	80.3	81.4	80.4	80.8	79.6	80.1

**Table 32. Projected Noise Levels in Ohio**

<b>Site</b>	<b>2008 Existing (Leq)</b>	<b>2035 No Build (Leq)</b>	<b>2035 Alternative B (Leq)</b>	<b>2035 Alternative C (Leq)</b>	<b>2035 Alternative D (Leq)</b>	<b>2035 Alternative E (Leq)</b>	<b>2035 Alternative G (Leq)</b>
OH-11 (C)	74.6	65.7	71	71	66.8	65.7	65.7
OH-12 (C)	70.5	75.4	75.5	74.7	75.8	76	75.5
OH-13 (C)	70.6	77	78.3	77.3	77.8	79.9	77.9
OH-14 (C)	72	73.2	74.5	73.4	75.8	74.7	73.4
OH-16 (C)	73.8	76.2	77.6	76.3	76.2	77.1	76
OH-17 (C)	65.6	68.3	73.4	68.8	67.9	68.9	68.5
OH-18 (B)	75.8	78.2	81	80.4	78.2	78.9	80.1
OH-20 (B)	69	71	76.6	77.3	71.7	75.5	76
OH-22 (B)	71.7	73.9	78.6	78	78.5	77.3	77.9
OH-25 (C)	69.2	70.7	73.8	73.5	74.7	72.6	73.8
OH-26 (B)	67.4	n/a	76.6	76.2	77.3	75.6	76.4
OH-27 (C)	71.5	74.1	76.9	76	76.1	75.1	75.7
OH-29 (B)	69.9	72.5	78.7	78	78.4	77.4	78.2
OH-31 (C)	76.2	78.8	81.8	75.9	81.2	80.4	80.9
OH-32 (B)	72.7	75.4	79.8	79	79.1	78.4	79.1
OH-33 (B)	75.4	77.8	82.6	82	82.4	81.4	82
OH-34 (C)	71.2	73.9	76.2	74.7	75.1	74.4	74.8
OH-35 (B)	69.1	n/a	77.1	76.8	77.9	76.1	76.7
OH-36 (C)	74.9	77.4	79.9	79.7	77.6	77.8	78.8
OH-37 (C)	74.1	76.6	78.9	77.6	78	77.2	77.8
OH-38 (B)	68.4	70.9	75.2	74.6	74.3	73.7	74.4
OH-39 (C)	74.9	77.4	80.3	79.4	77.3	78.2	79.5
OH-40 (B)	73.8	76.2	77.4	76.8	76.5	76	76.5

**Table 32. Projected Noise Levels in Ohio**

<b>Site</b>	<b>2008 Existing (Leq)</b>	<b>2035 No Build (Leq)</b>	<b>2035 Alternative B (Leq)</b>	<b>2035 Alternative C (Leq)</b>	<b>2035 Alternative D (Leq)</b>	<b>2035 Alternative E (Leq)</b>	<b>2035 Alternative G (Leq)</b>
OH-41 (B)	77.6	79.8	80.8	80	80.2	79.4	80
OH-42 (C)	70	72.5	76.7	72.9	72.9	72.4	72.6
OH-43 (B)	69.3	71.8	73.6	73.5	72.2	72.5	72.9
OH-44 (B)	75.8	78	79.3	78.3	78.6	77.4	77.9
OH-45 (C)	73.5	75.9	77.5	76.4	76.5	75.7	76.1
OH-46 (B)	72.7	75.2	77.3	75.4	75.2	75.5	76.3
OH-47 (C)	67.2	69	71.8	73.2	74	73.9	70.7
OH-48 (C)	66.4	67.6	71.9	67.9	67.3	68.1	68.1
OH-49 (C)	68.3	n/a	68.8	72.6	68.8	63.1	62.8
OH-50 (C)	65.6	69.7	71.6	69.1	66.9	69.9	69.2
OH-51 (C)	74.7	76.9	77.6	76.9	76.9	76.9	77.2
OH-52 (C)	70.6	73.6	73.4	72.7	73.5	73.2	72.9
OH-53 (C)	65.7	70.9	72	69.6	69.5	69.9	69.3
OH-54 (C)	71.8	76.1	76.8	75.4	75.3	74.6	74.9
OH-55 (C)	75.4	79.8	80.6	79.2	79.9	79	79.8

**4.9.1 No Build Alternative**

Table 31 indicates that, in 2008, existing noise levels approached or exceeded the FHWA Noise Abatement Criteria (NAC) of 66 dBA (Category B) at all but six noise receptors in Kentucky. These receptors include KY-5, 10, 11, 12, 29, and 30. Table 32 indicates that receptors OH-17, 50, and 53 did not approach or exceed the FHWA NAC of 66 dBA in Ohio in 2008.

In 2035, noise levels for the No Build Alternative approach or exceed the NAC of 66 dBA (Category B) at all receptor locations in Kentucky and Ohio. Noise levels for the No Build Alternative will approach or exceed the NAC of 71 dBA (Category C) at all but six noise receptors in Kentucky. Receptors KY-4, 10, 19, 29, 30, and 32 fall below this criterion. In Ohio, noise receptors approach or exceed the FHWA NAC of 71 dBA at all but eight locations. These locations include receptors OH-11, 17, 25, 38, 47, 48, 50, and 53.

It should be noted that receptors KY-1, 5, 7, 11, and 6 in Kentucky, were calculated to be in excess of 10 dBA above existing noise levels for the No Build and are considered to be a “substantial increase” according to the KYTC. In Ohio, there were no receptors calculated to be in excess of 10 dBA above existing noise levels for the No Build Alternative.

#### **4.9.2 Conceptual Build Alternatives**

In 2035, noise levels for the conceptual alternatives approach or exceed the NAC of 66 dBA (Category B) at all receptor locations in Kentucky. Ohio has two receptors; OH-11 and OH-49 which fall under the NAC 66 dBA criterion for Alternatives E and G.

In 2035, noise levels for Alternative B approach or exceed the NAC of 71 dBA (Category C) at all but eight receptor locations in Kentucky. These locations include KY-2, 10, 14, 19, 29, 30, 32, and 46. In Ohio, noise levels for all conceptual alternatives would exceed 71 dBA at all but one receptor location, OH-49.

In 2035, noise levels for Alternative C approach or exceed the NAC of 71 dBA (Category C) at all but six noise receptor locations in Kentucky. These locations include KY-10, 14, 19, 29, 30, and 32. In Ohio, noise levels exceeding 71 dBA include all but four noise receptor locations OH-17, 48, 50, and 53.

In 2035, noise levels for Alternative D approach or exceed the NAC of 71 dBA (Category C) at all but seven noise receptor locations in Kentucky. These locations include KY-2, 10, 14, 19, 29, 30, and 32. In Ohio, noise levels exceeding 71 dBA include all but six noise receptor locations, OH-11, 16, 48, 49, 50, and 53.

In 2035, noise levels for Alternative E approach or exceed the NAC of 71 dBA (Category C) at all but six noise receptor locations in Kentucky. These locations include KY-10, 19, 29, 30, 31, and 32. In Ohio, noise levels exceeding 71 dBA include all but six noise receptors, receptors OH-11, 17, 48, 49, 50, and 53.

In 2035, noise levels for Alternative G approach or exceed the NAC of 71 dBA (Category C) at all but five noise receptor locations in Kentucky. These locations include KY-10, 19, 29, 30 and 32. In Ohio, noise levels exceeding 71 dBA include all but six noise receptors, receptors OH-11, 17, 48, 49, 50, and 53.

It should be noted that depending on which 2035 Build Alternative was modeled in Kentucky or Ohio, some receptor values may be extremely high (+80 dBA). Modeling was used to generate the worst case scenario traffic forecasts, but the future noise levels for all conceptual alternatives were based upon the original 103 receptor locations from the 2008 No Build model. On occasion these locations were encroached upon by the conceptual alternatives, but the geographic location of the actual receptor was never moved.

#### **4.10 Utilities**

There are utilities in the study area that will be impacted by the conceptual alternatives. The potential utility conflicts and possible relocations are described in Table 33 for Kentucky and Table 34 for Ohio and are presented in Exhibit 20A – 20G. Alternative B would impact a total of 58 individual utilities (46 below ground and 12 aboveground) and

**ODOT PID 75119**  
**KYTC Item No. 6-17**  
**Conceptual Alternatives Study**

Alternatives C, D, E, and G would impact a total of 52 individual utilities (45 below ground and 7 aboveground).

**Table 33. Utility Impacts in Kentucky**

<b>Item Number<sup>1</sup></b>	<b>Utility</b>	<b>Description</b>	<b>Alternatives</b>
<b>Cincinnati Bell and Other Telecommunications Providers</b>			
1-3	Telephone Feeder Lines	Cincinnati Bell telephone overhead feeder lines drop and run underground along Rivard Drive at the existing Rivard Drive structure. I-71/I-75 mainline widening will require these lines to be relocated.	All (B, C, D, E, G)
2-2	Fiber Optic Lines	AT&T aerial fiber optics and Cincinnati Bell Telephone feeder lines are located on the Duke Energy poles along the west side of Crescent Avenue. I-71/I-75 mainline widening will require these lines to be relocated.	B
2-4	Duct Bank	Cincinnati Bell Telephone and AT&T duct banks located at KY 3 <sup>rd</sup> and Crescent Avenue in Covington and west along Route 8 to Western Avenue. New Ohio River bridge will require these lines to be relocated.	B
<b>Duke Energy</b>			
1-1	Electric Lines	Overhead transmission lines serving the Fort Mitchell Substation (approximately 120 feet south of Dixie Highway) and overhead electric lines approximately 890 feet north of Dixie Highway. I-71/I-75 mainline widening and ramp and structure construction may impact these lines.	All (B, C, D, E, G)
1-4	Gas Main	An 8-inch gas main is located under the I-71/I-75 mainline and ramps just south of the existing Kyles Lane bridge. I-71/I-75 mainline widening may require relocation of this main.	All (B, C, D, E, G)
1-8	Electric Line	A 138 kilovolt (KV) overhead transmission line crosses I-71/I-75 1,500 feet south of KY 12 <sup>th</sup> Street. West side grading and potential wall construction may impact the electric lines.	All (B, C, D, E, G)
1-10	Electric Lines	Two overhead electric lines crosses I-71/I-75, one crossing at KY 12 <sup>th</sup> Street and one crossing approximately 225 feet south of KY 12 <sup>th</sup> Street. I-71/I-75 mainline widening may require these lines to be relocated.	All (B, C, D, E, G)
1-12	Electric Line	A 69 KV overhead transmission line crosses I-71/I-75 approximately 120 feet north of KY 12 <sup>th</sup> Street and runs parallel to the west side of I-75 to near Pike Street. I-71/I-75 mainline and ramp widening may require this line to be relocated.	All (B, C, D, E, G)



**Table 33. Utility Impacts in Kentucky**

Item Number <sup>1</sup>	Utility	Description	Alternatives
2-1	Electric Line	A 69 KV overhead electric transmission line runs along the west side of Crescent Avenue in Covington. New Ohio River bridge will require these lines to be relocated from approximately 1,400 feet north of Pike Street to the Ohio River.	B
2-3	Gas Main	A 12-inch high pressure gas transmission main runs along Crescent Avenue in Covington. New Ohio River bridge will require these lines to be relocated from approximately 1,400 feet north of Pike Street to the Ohio River.	B
2-6	Electric Line	A 138 KV overhead electric transmission line runs along the west side of Western Avenue in Covington. New Ohio River bridge will require this line to be relocated from approximately 1,700 feet north of Pike Street to the Ohio River.	B
2-7	Electric Tower	An electric transmission tower supporting two 138 KV and 69 KV lines crossing the Ohio River and the actual aerial river crossing of these lines. New Ohio River bridge will require the tower and lines to be relocated	B
<b>Northern Kentucky Water District</b>			
1-5	Water Main	A 10-inch water main crosses the I-71/I-75 mainline under the Kyles Lane bridge. Structure construction will require relocation of this water main.	All (B, C, D, E, G)
1-11	Water Main	A 20-inch water main exists under KY 12 <sup>th</sup> Street in Covington at the I-71/I-75 crossing. This main may require relocation due to mainline structure construction.	All (B, C, D, E, G)
2-5	Water Main	A 20-inch water main is located near the north end of Western and Crescent avenues in Covington. Structure construction may require relocation of this water main.	B
<b>Sanitation District Number 1</b>			
1-2	Sanitary Sewer	Sanitary sewer crossing approximately 1,025 feet north of Dixie Highway. I-71/I-75 mainline widening may require the manhole to be relocated.	All (B, C, D, E, G)
1-6	Combined Sewer	A four-foot x four-foot box culvert serves as a combined sewer located approximately 5,000 feet north of Kyles Lane. I-71/I-75 mainline widening may require this culvert to be lengthened.	All (B, C, D, E, G)

**Table 33. Utility Impacts in Kentucky**

<b>Item Number<sup>1</sup></b>	<b>Utility</b>	<b>Description</b>	<b>Alternatives</b>
1-7	Storm Water Detention Basin	A regional storm water detention basin is located on the west side of I-75 approximately 1,900 feet south of KY 12 <sup>th</sup> Street in Covington. I-71/I-75 mainline widening may require modifications due to proposed grading and drainage construction. The existing sanitation District No 1 combined sewer running north from the detention basin along the west side of I-75 will require relocation/modification due to mainline widening.	All (B, C, D, E, G)
1-9	Combined Sewer	The Willow Run 108-inch diameter combined sewer. I-71/I-75 mainline widening and ramp construction will require relocation/modifications of the sewer line from approximately 1,500 feet south of KY 12 <sup>th</sup> Street in Covington to approximately 375 feet north of Pike Street.	All (B, C, D, E, G)
1-13	Combined Sewer	A 96-inch diameter combined sewer crosses I-71/I-75 at KY 9 <sup>th</sup> Street in Covington. I-71/I-75 mainline, ramp and structure widening will require relocation/modifications to the sewer line.	All (B, C, D, E, G)
1-14	Sanitary Sewer	A 27-inch diameter sanitary sewer by-pass runs along the east side of I-71/I-75 from just north of Pike Street in Covington to approximately 200 feet north of KY 9 <sup>th</sup> Street. I-71/I-75 mainline, ramp and structure widening will require relocation/modifications to the sewer line.	All (B, C, D, E, G)
1-15	Combined Sewer	A combined sewer line ranges in diameter from 36 to 60 inches. I-71/I-75 mainline widening will require relocation/modifications to the sewer line.	All (B, C, D, E, G)
2-13	Sanitary Sewer	A 33-inch sanitary sewer bypass crosses I-71/I-75 at a skew from Goebel Park in Covington on the east side to approximately 480 feet south of KY 5 <sup>th</sup> Street on the west side of I-71/I-75 where it widens to 36 inches. I-71/I-75 mainline widening will require relocation/modifications to this sewer line.	All (B, C, D, E, G)
2-14	Combined Sewer	The 12-foot x 14-foot Willow Run interceptor is located on the east side I-71/I-75 and crosses the interstate at a skew south of KY 5 <sup>th</sup> Street. I-71/I-75 mainline widening will require relocation/modifications to this sewer line from approximately 900 feet north of KY 9 <sup>th</sup> Street to KY 5 <sup>th</sup> Street.	All (B, C, D, E, G)

**Table 33. Utility Impacts in Kentucky**

Item Number <sup>1</sup>	Utility	Description	Alternatives
2-15	Storm Water Ponding Outlet	Two storm water ponding outlets (combined sewer overflows) are located in Goebel Park. I-71/I-75 mainline widening will require relocation/modifications to these ponding areas.	All (B, C, D, E, G)
2-16	Combined Sewer	A 48-inch diameter combined sewer runs west to east from Western Avenue toward I-71/I-75 between KY 3rd and KY 4th streets. I-71/I-75 mainline, ramp and structure widening will require relocation/modifications to the sewer line.	All (B, C, D, E, G)

<sup>1</sup> Item numbers represent utility identification numbers shown on Exhibit 20A – 20G.

**Table 34. Utility Impacts in Ohio**

Item Number <sup>1</sup>	Utility	Description	Alternatives
<b>Cincinnati Bell and Other Telecommunications Providers</b>			
2-12	Fiber Optic Line	AT&T fiber optic lines located in and near the intersection of Freeman Avenue and Gest Street. The connection of Alternative B with the original I-75 mainline may impact these lines.	B
2-20	Fiber Optic Line	Verizon and AT&T underground fiber optic lines; and Cincinnati Bell Telephone and Level 3 Communications underground duct banks in and along OH 3 <sup>rd</sup> Street. Interstate improvements may impact these lines.	All (B, C, D, E-G)
2-21	Fiber Optic Line	Verizon and MCI underground fiber optic lines run west from OH 4 <sup>th</sup> and Plum streets then south to OH 3 <sup>rd</sup> Street. Interstate improvements may impact these lines.	All (B, C, D, E, G)
2-24	Telephone Line	Duke Energy, Level 3 Communications and Cincinnati Bell Telephone conduits are hung on the Linn Street bridge over I-75. These lines will require relocation due to new structure construction.	All (B, C, D, E, G)
2-26	Fiber Optic Line	AT&T fiber optics in Duke Energy conduits cross at a skew under I-75 approximately 360 feet north of Linn Street. Interstate improvements may require relocation of these lines.	All (B, C, D, E, G)
2-27	Trunk Line	Cincinnati Bell Telephone and Level 3 Communications trunk lines cross under I-75 approximately 620 feet north of Linn Street. Interstate improvements may require relocation of these lines.	All (B, C, D, E, G)

**Table 34. Utility Impacts in Ohio**

<b>Item Number<sup>1</sup></b>	<b>Utility</b>	<b>Description</b>	<b>Alternatives</b>
2-28	Cell Tower	A multi-use cell tower is located on the east side of I-75 just north of Linn Street. Interstate improvements may require relocation of the cell tower.	All (B, C, D, E, G)
2-33	Fiber Optic Line	A Level 3 Communications trunk line is located along OH 3 <sup>rd</sup> Street. Interstate improvements may require relocation of this fiber optic line.	C, D, E, G
2-35	Fiber Optic Line	An AT&T underground fiber optics line runs approximately 410 feet north along the west side of I-75 from 3rd Street then runs west to Gest Street. Interstate improvements may require relocation of these lines.	C, D, E, G
3-2	Duct Bank	A Cincinnati Bell Telephone duct bank crosses I-75 approximately 425 feet south of Liberty Street, then runs north along the west side of I-75 to Dalton and Bank streets. Interstate improvements may require relocation of the duct bank.	All (B, C, D, E, G)
3-5	Duct Bank	A Cincinnati Bell Telephone duct bank crosses I-75 just north of Poplar Street, then runs north along the west side of I-75 to approximately 500 feet north of York Street. Interstate improvements may require relocation of the duct bank.	All (B, C, D, E, G)
3-12	Duct Bank	A Cincinnati Bell Telephone duct bank crosses I-75 approximately 500 feet north of the Western Hills Viaduct. I-75 mainline and ramp widening will require relocation of the duct bank.	All (B, C, D, E, G)
<b>Duke Energy</b>			
2-8	Transmission Tower	A transmission tower and 69 KV and 138 KV electric lines on the north bank of the Ohio River. New Ohio River bridge will require relocation of the tower and lines.	B
2-10	Electric Line	69 KV overhead transmission lines are located just north of Mehring Way. New Ohio River bridge will require relocation of these lines.	B
2-18	Electric Line	A 138 KV underground oil filled transmission line runs east, parallel to and 240 feet south of Pete Rose Way, then north along Central Avenue. Interstate improvements may require relocation of this line.	All (B, C, D, E, G)
2-19	Electric Line	A 69 KV underground oil filled transmission line runs north from Pete Rose Way under existing I-75 structures then east along OH 3 <sup>rd</sup> Street. Interstate improvements may require relocation of this line.	All (B, C, D, E, G)

**Table 34. Utility Impacts in Ohio**

Item Number <sup>1</sup>	Utility	Description	Alternatives
2-21	Oil Transmission Line	Verizon and MCI underground fiber optics running west from 4th and Plum streets in Cincinnati then south to 3rd Street may be impacted.	All (B, C, D, E, G)
2-26	Fiber Optic Line	The AT&T fiber optics in Duke Energy conduits crossing at a skew under I-75 approximately 360' north of Linn Street in Cincinnati may require relocations depending on potential mainline profile revisions.	All (B, C, D, E, G)
3-7	Electric Line	Primary underground electric lines cross I-75 approximately 90 feet south of York Street. Interstate improvements will require relocation of these lines.	All (B, C, D, E, G)
2-31	Substation	West End substation located on the north bank of the Ohio River. Interstate improvements will require relocation of this substation.	C, D, E, G
2-32	Electric Line	A 138 KV underground oil filled transmission line is located just east of the West End substation. Interstate improvements may require relocation of this line where it crosses Rose Street.	C, D, E, G
3-9	Gas Main Line	A 24-inch gas main runs north along the east side of Spring Grove Avenue/west side of I-75 from Bank Street to north of the Western Hills Viaduct. Improvements to the Western Hills Viaduct connection may impact this line.	All (B, C, D, E, G)
3-11	Electric Line	Primary underground electric line crosses I-75 approximately 500 feet north of the Western Hills Viaduct. I-75 mainline and ramp widening may require relocation of this line.	All (B, C, D, E, G)
3-14	Electric Line	Overhead electric lines located west of the Western Hills Viaduct. Improvements to the Western Hills Viaduct connection may impact these lines.	All (B, C, D, E, G)
<b>Metropolitan Sewer District (MSD)</b>			
2-9	Combined Sewer	A 66-inch and a 72-inch combined sewer lines are located between the Ohio River and Mehring Way. These lines may require relocation depending on structure location.	B
2-17	Combined Sewer	A 48-inch and two 60-inch combined sewers located in the area of Central Avenue, OH 2 <sup>nd</sup> and OH 3 <sup>rd</sup> streets. Interstate improvements may impact these lines.	All (B, C, D, E, G)
2-22	Combined Sewer	A 36-inch combined sewer is located under I-75 approximately 400 feet north of OH 8 <sup>th</sup> Street. I-75 mainline and ramp widening may require relocation of this line.	All (B, C, D, E, G)

Table 34. Utility Impacts in Ohio

Item Number <sup>1</sup>	Utility	Description	Alternatives
2-25	Combined Sewer	A 66-inch combined sewer under I-75 runs northwest from the Linn Street overpass on the east side of I-75. I-75 mainline widening may require relocation of this line.	All (B, C, D, E, G)
2-29	Combined Sewer	A 78-inch combined sewer is located near the intersection of Gest Street and Freeman Avenue. I-75 mainline widening may impact this line.	B
2-30	Combined Sewer	60-inch and 72-inch combined sewers cross I-75 approximately 300 feet south of Ezzard Charles Drive and parallel the east side of I-75 south to Clark Street. I-75 mainline widening may require relocation of these lines.	All (B, C, D, E, G)
3-1	Combined Sewer	A 30-inch combined sewer crosses I-75 approximately 425 feet south of Liberty Street. I-75 mainline widening may require relocation or modification of this line.	All (B, C, D, E, G)
3-8	Combined Sewer	A 30-inch combined sewer crosses I-75 just north of York Street. I-75 mainline widening may require relocation of this line.	All (B, C, D, E, G)
<b>Cincinnati Water Works</b>			
2-11	Water Main	A 20-inch water main runs along West OH 3 <sup>rd</sup> Street, west of Gest Street. Interstate improvements may require relocation of this main.	B
2-23	Water Main	A 36-inch water main crosses I-75 approximately 545 feet north of OH 8 <sup>th</sup> Street and then runs north along the west side of I-75/Gest Street. I-75 mainline widening may require relocation of this main.	All (B, C, D, E, G)
2-34	Water Main	A 24-inch water main runs along OH 3 <sup>rd</sup> Street. I-75 improvements may impact this main.	All Mainline Alternatives (C, D, E, G)
3-3	Water Main	A 42-inch water main crosses under I-75 at Liberty Street. I-75 mainline widening may require relocation of this main.	All (B, C, D, E, G)
3-4	Water Main	A 36-inch water main runs north from Liberty Street to approximately 270 feet north of York Street along the west side of I-75. I-75 mainline widening and retaining wall construction may impact this main.	All (B, C, D, E, G)
3-6	Water Main	A 24-inch water main crosses under I-75 at Findlay Street. I-75 mainline widening may require relocation of this main on the west side of I-75.	All (B, C, D, E, G)
3-10	Water Main	A 48-inch water main is located in Central Parkway at the east end of the Western Hills Viaduct. Improvements to the Western Hills Viaduct connection may impact this main.	All (B, C, D, E, G)

**Table 34. Utility Impacts in Ohio**

Item Number <sup>1</sup>	Utility	Description	Alternatives
3-13	Water Main	A 48-inch water main crosses I-75 approximately 1,100 feet north of the Western Hills Viaduct. I-75 mainline widening may require relocation of this main.	All (B, C, D, E, G)

<sup>1</sup>Item numbers represent utility identification numbers shown on Exhibit 20A – 20G.

The building that houses the Advanced Regional Traffic Interactive Management and Information System (ARTIMIS) operation will be affected by all conceptual alternatives and will need to be rebuilt. This building is located north of Third Street between northbound I-75 and southbound I-75.

Utility impacts in Kentucky include two gravity fed sewer lines and high voltage electric lines. There is a 33-inch sanitary sewer bypass which crosses I-71/I-75 at a skew from Goebel Park in Covington to approximately 480 feet south of KY 5<sup>th</sup> Street on the west side of I-71/I-75 where it widens to 36 inches. I-71/I-75 mainline widening will require relocation/modifications to this sewer line. The 12-foot x 14-foot Willow Run interceptor is located on the east side I-71/I-75 and crosses the interstate at a skew south of KY 5<sup>th</sup> Street. I-71/I-75 mainline widening will also require relocation/modifications to this sewer line from approximately 900 feet north of KY 9<sup>th</sup> Street to KY 5<sup>th</sup> Street. The high voltage electric lines parallel Western and Crescent avenues and could be impacted by the conceptual alternatives.

Notable utility impacts in Ohio include the Duke Energy West End substation and oil filled transmission lines; and two combined sewer lines that cross under I-75 north of OH 9<sup>th</sup> Street.

Duke Energy conducted an assessment of the impacts that the conceptual alternatives would have on their utilities in 2008. An overview of the required work and costs associated with relocation of the utilities was also prepared for the conceptual alternatives. Letters received from Duke Energy dated April 11, 2008, June 24, 2008, and January 30, 2009 documenting the assessment of the alternatives are located in Appendix G.

Duke Energy determined that Alternative B would require six overhead transmission lines consisting of four 138 kilovolt (KV) circuits and two 69 KV circuit to be relocated. Duke Energy developed three alternatives for relocating the lines with non-inflated estimated costs ranging from \$24 to \$100 million (2008 dollars) for Alternative B. At the low end of costs, the relocated lines would need to cross over the new bridge over the Ohio River at various locations and cross over the new bridge in Ohio. At the middle range of costs, the relocated lines would be placed in conduits attached to the new bridge. At the high end of costs, the relocated lines would be relocated underground. These estimated costs have not been adjusted for inflation.

Duke Energy determined the other conceptual alternatives would have the same impacts on Duke Energy's infrastructure. Duke Energy determined that utility relocations for Alternatives C, D, E, and G would include the West End substation adjacent to the existing Brent Spence Bridge and four transmission lines consisting of two overhead 138

KV circuits and two underground 138 KV circuits. The non-inflated cost of the utilities relocations for Duke Energy was estimated to be \$22.5 million (2008 dollars) for Alternatives C, D, E, and G. Estimated cost has not been adjusted for inflation.

## **5.0 PUBLIC INVOLVEMENT AND AGENCY COORDINATION**

Public participation for the Brent Spence Bridge Replacement/Rehabilitation Project has been in accordance with Ohio Department of Transportation's (ODOT) Major Project Development Process (PDP). Public involvement was initiated in Step 1 and will continue through project development to Step 14 of the process. In Kentucky, public involvement has been in accordance with the Kentucky Transportation Cabinet's (KYTC) Project Delivery Core Process. Public involvement was initiated during the Transportation Decision Making Process and will continue through project development. All public involvement activities are communicated to, approved by, and coordinated through the project managers for KYTC and ODOT.

### **5.1 Public Involvement**

A Public Involvement Plan (PIP) was prepared for the Brent Spence Bridge Replacement/Rehabilitation Project for Steps 1-4 of the PDP, and updated for Step 5. KYTC and ODOT recognize that a proactive, effective communications effort will enhance this project's outcome. Soliciting ideas and input from stakeholders and residents will provide the constructive feedback necessary for the successful implementation of needed transportation improvements. A coordinated communications program also educates the public on the long-term benefits of the infrastructure improvements under consideration, such as increased travel safety and improved mobility.

All informational materials are updated as new information becomes available to keep information accurate and to ensure up-to-date communication is being maintained. The PIP will be updated to prepare for upcoming public outreach needs for Step 5 and beyond. Since public involvement is a fluid process, all communication tools used in this plan must remain flexible to meet the changing needs of the Advisory Committee and the general public. The following lists a summary of the public involvement activities that have taken place through Step 5.

- Establishment of project identity
- Establishment of an Advisory Committee
  - Advisory Committee meetings
  - Advisory Committee survey
- Establishment of an Aesthetic Committee
- Identification and engagement of environmental justice populations
- Community meetings
- Public meetings
- Project newsletters
- Web site coordination
- Media relations
- Project fact sheets
- Roving information display



### **5.1.1 Advisory and Aesthetic Committees**

At the outset of the project, KYTC and ODOT instituted two committees to help provide guidance to the Project Team. The Advisory Committee provides input from local community and political leaders on community issues and concerns. This provides an opportunity for important issues brought up to the Advisory Committee to be communicated back to the contingencies represented by the members of the Advisory Committee.

The Aesthetics Committee, a sub-committee of the Advisory Committee, provides local input on the design and aesthetic appearance of the corridor and the main span of the Brent Spence Bridge. As the project moves forward, more detail is provided to and from this committee in order to give input on community values with respect to the aesthetics of the bridge.

A total of six Advisory Committee meetings have been held to date. Three meetings were held during Step 5 of the PDP on July 27, 2006, February 25, 2008, and April 20, 2009. Agendas and meeting minutes for each Advisory Committee Meeting are posted to the project web site.

A total of two Aesthetic Committee meetings have been held to date for this project. The first meeting was held on December 16, 2005 and the second on August 29, 2006. Agendas and meeting minutes for each Aesthetic Committee meeting are posted to the project web site. The next Aesthetic Committee meeting will be held as part of Concurrence Point #2.

### **5.1.2 Project Web Site**

A web site was established for the Brent Spence Bridge Replacement/Rehabilitation Project, [www.brentspencebridgecorridor.com](http://www.brentspencebridgecorridor.com). This web site has received a large amount of public notoriety because of the scale and magnitude of the project. The web site has been active and media coverage of alternatives and other elements of the project have generated an increase in web site visits and web comments. The web site is updated to reflect the latest information and technical reports associated with the project development. A "What's New" link helps site visitors to locate the latest planning and engineering documentation.

In addition, the project web site includes a feedback link that provides an opportunity for anyone to make comments and ask questions about the project. Comments submitted through the web site receive a written reply from the Project Team. A list of the comments received is provided in Appendix E.

### **5.1.3 Project Newsletters**

Two traditional newsletters were prepared and distributed to approximately 250 individuals and organizations to date. The first newsletter was mailed in February 2006 and provided background, project purpose, contact information, project schedule, a list of Advisory Committee member organizations, and a map of the project study area. The second was mailed in January 2007 and provided details about the alternatives that were carried forward through Step 4. Both newsletters were posted to the project web site and included in Appendix E.

Two E-Newsletters were developed to facilitate communications with the Advisory Committee between general mail newsletters, public meetings, and Advisory Committee meetings. The first E-Newsletter was sent out in June 2007 and the second in August 2007. The E-newsletters are included in Appendix E. A third will be distributed in advance of the Concurrence Point #2 public meetings scheduled for May 6 and 7, 2009.

#### **5.1.4 Media Relations**

The media has provided positive support and accurate communication about the Brent Spence Bridge Replacement/Rehabilitation Project. It has been on the front page of various local news publications numerous times, primarily because of the scale and magnitude of the project. The coverage of the conceptual alternatives and potential design concepts for the project has been moderate. The announcement of the recommended conceptual alternatives for the project generated a significant amount of media interest. However, as cost estimates have been developed there has been an increase in concern regarding project costs and funding sources. Currently, project cost, funding, and schedule have been the primary focus of the media.

As the project moves forward, media relations will be maintained in order to provide information to the media so they can help communicate any messages that are important in obtaining community response. Contact with reporters is maintained by KYTC, ODOT, and the Project Team.

#### **5.1.5 Roving Project Display**

A project display was developed and available to the public at public buildings and high traffic areas within the study area with the purpose of extending project outreach efforts. This display appeared at public buildings and high traffic areas throughout 2006. Currently, the project display is used on an as needed basis.

## **5.2 Public Meetings and Concurrence Points**

### **5.2.1 Community Meetings**

Project managers from KYTC and ODOT have met individually with local government officials, residential organizations, professional societies, and other interested parties in the greater Cincinnati-Northern Kentucky area to discuss the project, answer questions, and address concerns (Table 35).

**Table 35. Project Meetings and Presentations within the Cincinnati-Northern Kentucky area**

<b>Date</b>	<b>Organization</b>
March 15, 2007	American Society of Civil Engineers
March 22, 2007	Lewisburg Neighborhood Association
May 1, 2007	Northern Kentucky Sanitation District #1
July 27, 2007	City of Covington
September 12, 2007	City of Covington/City of Cincinnati
January 11, 2008	City of Covington/City of Cincinnati
May 15, 2008	Special Stakeholder Meeting
May 22, 2008	City of Covington
May 29, 2008	Lewisburg/Downtown Covington/Botany Hill Neighborhood Associations

**Table 35. Project Meetings and Presentations within the Cincinnati-Northern Kentucky area**

Date	Organization
June 6, 2008	Northern Kentucky Developers Day
June 24, 2008	Transportation and Infrastructure Subcommittee of Cincinnati City Council
August 25, 2008	City of Covington

**5.2.2 Concurrence Point #1**

Two public meetings were held for Concurrence Point #1 on May 2 and 4, 2006. These public meetings were held to present work completed in Steps 1 through 4 of the PDP. The purpose of the meetings was to inform the public about the Purpose and Need Statement, Red Flag Summary, Existing and Future Conditions, and Conceptual Alternatives Solutions. Public comments received from Concurrence Point #1 are included in Appendix E.

Based on the public comments received, there was a general consensus that improvements are needed in the I-71/I-75 corridor. The comments provided by the public and community representatives from Concurrence Point #1 have been used to refine the conceptual alternatives throughout Step 5. Section 5.2.3 discusses how the public comments were incorporated into the development of the conceptual alternatives.

**5.2.3 Public Comments**

Public comments received by the Project Team have been reviewed and taken into consideration in the development of the conceptual alternatives. Table 36 provides a summary of the primary topics of concern expressed in the public comments received to date. Public comments are included in Appendix E.

**Table 36. Summary of Public Comments**

Comment	Response
Ohio concerns about the Queensgate alignment due to impacts to businesses.	<p>Alternative A (formerly Alternative 1) has been dismissed from further study. The reasons for elimination of Alternative A are discussed in Section 2.4.1. Alternative B (formerly Alternative 2) is recommended for elimination from further study for reasons presented in Section 7.2.</p> <p>These alignments have met with public opposition due to the impacts to the business community. In addition, the City of Cincinnati is currently working to develop vacant land in the path of Alternative B.</p>

**Table 36. Summary of Public Comments**

Comment	Response
<p>Kentucky concerns about the Queensgate alignment due to impacts to neighborhoods and businesses.</p>	<p>Alternative A (formerly Alternative 1) has been dismissed from further study. The reasons for elimination of Alternative A are discussed in Section 2.4.1. Alternative B (formerly Alternative 2) is recommended for elimination from further study for reasons presented in Section 7.2.</p> <p>Neighborhood impacts are expected for Western and Crescent Avenues from all alternatives recommended for further study. These impacts will be minimized to the extent possible as the alternatives are developed in more detail.</p>
<p>Concerns about the impact on noise levels created by the project</p>	<p>A noise screening was completed for the project. This study analyzed existing and future noise levels within the study area. This analysis is presented in Section 4.9. Existing noise levels are high and approach or exceed FHWA noise abatement criteria (NAC). In 2035, noise levels for the No Build Alternative and conceptual alternatives will also approach or exceed FHWA NAC. Noise mitigation such as noise walls will be developed for the preferred alternative.</p>
<p>Concerns about maintaining access to the downtown areas of both Cincinnati and Covington</p>	<p>This project will improve and fundamentally change access between the interstate system and the urban areas of Covington and Cincinnati. Access to the downtown areas are described for each conceptual alternative in Section 2.3. By providing a system of local collector-distributor road connections, access between Covington, Cincinnati and other communities adjacent to this project will also improve.</p>
<p>Concerns about the availability of mass transit options</p>	<p>Planning for regional light rail was developed as part of the <i>North-South Transportation Initiative</i> (2004). The planned regional light rail line would follow the I-75 corridor and provide service to Cincinnati and northern Kentucky. It is anticipated that light rail would use the Clay Wade Bailey Bridge to cross the Ohio River and not the Brent Spence Bridge. As shown in Exhibits 4 through 10 and cross section plans in Appendix B, the planned regional light rail line would be accommodated in the I-71/I-75 corridor south of the Ohio River (south of KY 12<sup>th</sup> Street) and north of Western Hills Viaduct.</p> <p>In addition, the City of Cincinnati is currently in the early stages of advancing a street car project to serve the downtown area.</p>

**Table 36. Summary of Public Comments**

Comment	Response
Alternatives that have not been considered (most notably, a tunnel)	Several options to improve the Brent Spence Bridge have been studied over the years. Development of conceptual alternatives for the Brent Spence Bridge was initiated in 2003 by KYTC. These initial alternatives were documented in the <i>Feasibility and Constructability Study of the Replacement/ Rehabilitation of the Brent Spence Bridge (May 2005)</i> . In 2006, 25 conceptual alternatives, including the No-Build Alternative, were developed in Step 4 of the ODOT Project Development Process. These 25 conceptual alternatives included the six alternatives from the 2005 <i>Feasibility and Constructability Study</i> . The 25 conceptual alternatives were evaluated using a two-phased screening process based on a comparative analysis. The conceptual alternatives evaluated in this report represent the best of the alternatives considered for improving transportation in the I-71/I-75 corridor.
Requests for where to find project updates	The project website ( <a href="http://www.brentspencebridgecorridor.com">www.brentspencebridgecorridor.com</a> ) includes project documents and all of the alternatives considered. As always, public input is welcomed and encouraged at any time.
Concerns regarding impacts to historical properties, most notably Longworth Hall	The project study area includes many historic resources, including Longworth Hall. The project has studied several alternatives to date and potential impacts to historical properties have been a primary concern. Impacts to Longworth Hall and all historic resources will be minimized to the extent possible as the alternatives are developed in more detail in future steps of the PDP.
Efforts to keep trucks out of the high-speed lanes in this corridor	A signage plan will be developed for the preferred alternative, which will direct truck traffic into the appropriate lanes. However, compliance with these signs will rely on how this policy is enforced, similar to the situation as it exists today.
Efforts to divert truck traffic	The Ohio-Kentucky-Indiana Regional Council of Governments performed a Truck Ban Study that was completed in 2007. Essentially, it concluded that a truck ban would not be effective in terms of providing either congestion relief or safety improvements. The study further estimated that a truck ban would have a detrimental impact to the local economy given the amount of deliveries that are made within the I-275 beltway. The Ohio-Kentucky-Indiana Regional Council of Governments' website <a href="http://www.oki.org">www.oki.org</a> has information on that study.
Concerns about the look of a new bridge structure.	At this stage of project development, the goal is to identify a preferred alternative alignment. Once a preferred alternative is identified, other design details such as bridge type will be addressed. The project has formed an Aesthetics Committee representing many community interests to provide further input on the type and style of structure to be built.

**5.2.4 Concurrence Point #2**

Public meetings for Concurrence Point #2 are scheduled to be held on May 6<sup>th</sup> and 7<sup>th</sup> 2009. One meeting will be held in Kentucky and one in Ohio. These meetings will present the feasible alternatives recommended for further study and the results of this *Conceptual Alternatives Study*. The public will have an opportunity to comment on the recommendations of this study.

### **5.3 Agency Coordination**

An important element of the environmental process is the integration of the National Environmental Policy Act (NEPA) with other planning and environmental review procedures required by law or agency practice (i.e. Section 106 of the National Historic Preservation Act). KYTC, ODOT, and the Federal Highway Administration (FHWA) have entered into agreements with federal and state resource agencies in an effort to standardize procedures for environmental investigations and project reviews, streamline the review process, and develop mitigation measures.

#### **5.3.1 Participating and Cooperating Agencies**

In accordance with Section 6002 of the Safe, Accountable, Flexible, Efficient Transportation Equity Act: A Legacy for Users (SAFETEA-LU), an Agency Coordination Plan was developed. As part of the Agency Coordination Plan, KYTC, ODOT, and FHWA invited federal, state, and local agencies to participate in the project. Agencies responded either by letter or e-mail accepting or declining the invitation to participate. Table 37 provides a list of agencies invited and whether or not they accepted the invitation to participate in the Brent Spence Bridge Replacement/Rehabilitation Project.

**Table 37. Agencies Invited to Participate**

<b>Agency</b>	<b>Participating (Yes or No)</b>
<b>Federal</b>	
Federal Emergency Management Agency	No
Federal Transit Administration	No
US Army Corps of Engineers	Yes
US Coast Guard	Yes
US Environmental Protection	Yes
US Fish and Wildlife Service	Yes
<b>State of Ohio</b>	
Ohio Department of Agriculture	No
Ohio Department of Natural Resources	Yes
Ohio Environmental Protection Agency	Yes
Ohio Historic Preservation Office	No
<b>Commonwealth of Kentucky</b>	
Environmental and Public Protection Cabinet	No
Kentucky Cabinet for Economic Development	No
Kentucky Department of Agriculture	No
Kentucky Department Environmental Protection	Yes
Kentucky Department of Fish and Wildlife Resources	Yes
Kentucky Department of Natural Resources	No
Kentucky Environmental Education Council	No
Kentucky Environmental Quality Commission	No
Kentucky Heritage Council, State Historic Preservation Office	No
Office for Consumer & Environmental Protection	No
State Nature Preserves Commission	No

**5.3.2 Natural Resources Coordination**

During development of the *Red Flag Summary Report* (December 2005) coordination was initiated with US Fish and Wildlife Service, Ohio Department of Natural Resources, Kentucky Department of Fish and Wildlife Resources, Kentucky Department of Natural Resources, and Kentucky State Nature Preserves Commission regarding ecological resources. Table 38 presents the agency coordination for the Brent Spence Bridge Replacement/Rehabilitation Project. Ecological coordination will continue to meet the NEPA interagency coordination requirements, the US Fish and Wildlife Coordination Act requirements, Section 7 of the Endangered Species Act requirements, and to provide pre-application coordination for necessary permits. Ecological documentation for ODOT *Level One Ecological Survey Report – Ohio* (ODOT PID No. 75119) (February 2007) and KYTC - *Level One Ecological Survey Report – Kentucky* (KYTC Item No.6-17) (February 2007) are being coordinated in each respective state. In a letter dated August 16, 2006, the US Fish and Wildlife Service (USFWS) Reynoldsburg, Ohio Office accepted the invitation to act as a participating agency and further noted that they would serve as the lead USFWS field office on the project.

**Table 38. Agency Coordination**

Agency	Coordination
<ul style="list-style-type: none"> <li>• Ohio Department of Natural Resources</li> <li>• Kentucky Department of Fish and Wildlife Resources</li> <li>• US Fish and Wildlife Service</li> </ul>	Contacted to determine the presence of unique or significant ecological resources such as threatened and/or endangered species, champion trees, geologic features, natural preserves, state parks, forested or wildlife areas, breeding or non-breeding animal concentrations and rare habitat.
<ul style="list-style-type: none"> <li>• US Coast Guard</li> </ul>	Contacted to initiate coordination on pier placement and navigation requirements for new Ohio River bridge options.
<ul style="list-style-type: none"> <li>• US Environmental Protection Agency</li> <li>• Ohio Environmental Protection Agency</li> <li>• Kentucky Department of Environmental Protection</li> </ul>	Contacted for river mile and water quality data.
<ul style="list-style-type: none"> <li>• Ohio Historic Preservation Office</li> <li>• Kentucky Heritage Council</li> </ul>	<p>Contacted to determine the presence of significant historic and archaeological resources such as properties listed or eligible for the National Register of Historic Places, National Historic Landmarks, historic bridges, and Ohio Historic Inventory properties.</p> <p>Section 106 coordination for Phase I historic architecture surveys (Kentucky and Ohio) and the Phase II historic architecture survey (Ohio) to determine which properties in the study area are eligible for listing on the National Register of Historic Places.</p>

As part of the process for developing conceptual alternatives, the Project Team has coordinated with the United States Coast Guard (USCG) for navigation requirements and pier locations for the Ohio River. Currently the project is proposing a new Ohio River bridge at one of two locations based on the alternatives currently being studied. USCG had requested information from ODOT with letters dated October 3, 2006 and November 14, 2006. The Project Team responded to these letters and provided the requested information in a letter dated February 7, 2007. Coordination with the USCG to determine the appropriate pier spreads and location in respect to the Ohio River navigational channel will continue throughout preliminary design of the conceptual alternatives.

### **5.3.3 Cultural Resources Coordination**

The Section 106 of the National Historic Preservation Act of 1966 requires federal agencies to take into account the effects of their projects on historic properties. The Section 106 process requires the coordination of findings of the Section 106 investigations with the Kentucky Heritage Council (KHC) and the Ohio Historic Preservation Office (OHPO) as well as other defined consulting parties. Table 39 provides a list of local, state, and federal consulting parties for the Brent Spence Bridge Replacement/Rehabilitation Project.

**Table 39. Consulting Parties**

<b>Consulting Party</b>	<b>Ohio</b>	<b>Kentucky</b>
<b>Local Agencies</b>	Cincinnati Historic Conservation Office Cincinnati Preservation Association Historic Southwest Ohio, Inc. - Hauch House Dayton Street Historic District Association Lower Price Hill Community Council Price Hill Civic Club West End Community Council Cincinnati Metropolitan Housing Authority Community Revitalization Agency Cincinnati Park Board	Kenton County Fiscal Court - Judge Executive City of Covington – Mayor City of Covington – Historic Preservation
<b>Local Community Groups</b>	Cincinnati Museum Center	Lewisburg Neighborhood Association Covington Neighborhood Services Coordination Kenton Hills West Covington/Botany Hills Botany Hills Neighborhood (West Covington) Westside (Westside Action Coalition) Mainstrasse Village Association
<b>State Agencies</b>	Ohio Historic Preservation Office	Kentucky Heritage Council
<b>Federal Agencies</b>	FHWA, Urban Programs Engineer	FHWA, Kentucky Division

Section 106 coordination with consulting parties was initiated in Steps 1 through 4 of the PDP. Written coordination as well as meetings and site visits with consulting parties



resulted in concurrence of a defined Area of Potential Effects (APE) and potential impacts on cultural resources. Meetings with consulting parties in Ohio were held on August 10 and November 16, 2006. Meetings with consulting parties in Kentucky were held on August 30 and November 29, 2006.

Phase I and II historic architecture surveys were completed to determine which properties in the study area are eligible for listing on the National Register of Historic Places. The results of these surveys are presented in *Phase I History/Architecture Survey Report: Hamilton County, Ohio (June 2007)*; *Phase I History/Architecture Survey Report: Kenton County, Kentucky (March 2007; revised November 2008)*; and *Phase II History/Architecture Investigations: Hamilton County, Ohio (December 2008)*. The reports were coordinated with their respective consulting parties in Kentucky and Ohio in 2007. The reports completed in 2008 will be coordinated with their respective consulting parties in Kentucky and Ohio in 2009.

Meetings with KHC and OHPO were held to discuss eligibility determinations of historic resources within the study area and potential impacts to these resources. A meeting was held on October 30, 2007 with KHC and another meeting was held on October 30, 2008 with OHPO.

#### **5.3.4 Section 4(f) Coordination**

Section 4(f) coordination with local government officials was initiated in 2008 for Goebel Park in Kentucky and the Queensgate Ballfields in Ohio.

On September 30, 2008, representatives from KYTC and the City of Covington met at Goebel Park to discuss impacts that the conceptual alternatives would have to the western section of the park adjacent to I-71/I-75. All conceptual alternatives would require right of way from the park ranging from approximately 0.35 acres to 2.6 acres. All of the alternatives would displace a radio tower and all but one alternative would displace a basketball court. Three conceptual alternatives would impact a portion of a bicycle and pedestrian path. Mitigation options were discussed during this meeting.

On November 3, 2008, representatives from the Project Team and the Cincinnati Recreation Commission met at the Queensgate Ballfields to discuss impacts that the conceptual alternatives would have to the southern section of the park adjacent to I-71/I-75. Three of the conceptual alternatives would impact the Queensgate Ballfields (Alternatives C, D, and G). Impacts consist of strip takings ranging between 0.29 and 0.45 acres along the existing I-75 right of way.

#### **5.4 Utility Coordination**

Coordination with utility companies was initiated in 2006. The following 13 utility companies have been identified as having facilities in the study area:

- Duke Energy (gas and electric)
- Cincinnati Water Works
- Northern Kentucky Water District
- Metropolitan Sewer District (Greater Cincinnati)
- Sanitation District Number 1 (Northern Kentucky)
- Cincinnati Bell (telephone)

- AT&T Fiber Optics
- Insight Communications
- Level 3 Communications, LLC
- MCI/Verizon Fiber Optic
- Sprint Fiber Optic
- Time Warner Cable
- Qwest national Network Services

A utility coordination meeting was held on March 16, 2006. The purpose of the meeting was to provide initial project information and to begin coordination between the Project Team and utility companies. The result of the meeting led to the formation of a utility coordination team consisting of utility and Project Team representatives that will continue to coordinate preliminary engineering to ensure that no loss of service occurs during construction or operation. The Project Team has continued coordination with the utility companies since the March 16<sup>th</sup> meeting. Documentation provided by the utility companies is provided in Appendix G.

Duke Energy conducted an assessment of the impacts that the conceptual alternatives would have on their utilities in 2008. An overview of the required work and costs associated with relocation of the utilities was also prepared for the conceptual alternatives. This information was provided to the Project Team to use in the development of the conceptual alternatives. Documentation provided by Duke Energy is provided in Appendix G.

#### **5.4.1 Railroad Coordination**

The existing rail lines in the project area include:

- CSX Transportation
- Norfolk Southern
- Indiana and Ohio (I&O)
- Amtrak (passenger rail)

CSX Transportation and Norfolk Southern have classification and intermodal yards in the Queensgate area of Cincinnati. CSX Transportation's Queensgate Yard has the capacity for 4,000 rail cars, and is one of the busiest freight rail yards in the Midwest.

CSX Transportation and Norfolk Southern have lines that parallel I-75. Two other railroads, Amtrak and the Indiana and Ohio Railway have "trackage rights" over these rail lines. More than 90 trains per day use the tracks in this corridor. Even though the two major railroads are competitors, they have a special operating agreement that allows each railroad to use the other's tracks due the rail congestion issues in this corridor.

Initial coordination with railroad companies provided the following clearance information:

- The required minimum overhead clearance is 23 feet.
- The required minimum lateral clearance (from centerline of track) is 25 feet, less would require crash walls.

No additional railroad coordination was completed during Step 5 since no impacts are expected to railroads.

## **6.0 STRATEGIC PLAN**

### **6.1 Project Development Process**

The Brent Spence Bridge Replacement/Rehabilitation Project is being implemented using the Ohio Department of Transportation's (ODOT) Project Development Process (PDP). Steps 1 through 8 comprise the planning process. The results of Step 5 and portions of Step 6 tasks are described in this *Conceptual Alternatives Study*. This report recommends feasible alternatives for further evaluation. The Strategic Plan describes the implementation plan for the Steps 6 through 8 and for final design and construction. This plan will be updated throughout the PDP.

Table 40 summarizes ODOT's Major PDP Steps 5 through 14. Steps 5 through 8 develop alternatives through Stage I design and assess the environmental impacts of the alternatives. Environmental documentation is completed and a Preferred Alternative is selected during these steps. Steps 9 through 12 include right of way acquisition and final design. Steps 13 and 14 are project construction. The current bi-state agreement between Ohio and Kentucky calls for the Kentucky Transportation Cabinet (KYTC) to assume management of the Kentucky portion of the Brent Spence Bridge project after completion of Step 8. This includes all improvements from Dixie Highway, Kyles Lane, the collector-distributor and climbing lanes south of the Brent Spence Bridge, the southern approaches to the Bridge, and the main span of the Bridge. This bi-state agreement calls for ODOT to follow Steps 9 through 14 for the Ohio approaches, the connections to US 50, the I-71/I-75/US 50 Interchange, the I-75 mainline, and the Western Hills Viaduct independent of Kentucky's planning and design effort. This plan presents recommendations for the integration of these efforts into a coordinated implementation strategy. The complexity and interdependency of the design and construction and the impact on maintenance of traffic and constructability suggest a continued integrated effort by Kentucky and Ohio.

KYTC's and ODOT's design, construction, maintenance, and financial responsibilities are defined at approximately N39°05.516'/W85°31.324'.

**Table 40. ODOT's Major PDP Steps 5 through 14**

<b>PDP Step and Key Engineering Components</b>	<b>Activities Performed During Step</b>
Step 5	
Develop Conceptual Alternatives	<ul style="list-style-type: none"> <li>• Address public involvement issues</li> <li>• Select corridors for further study</li> <li>• Develop preliminary Engineering/environmental scope of services</li> <li>• Perform environmental field studies</li> <li>• Submit <i>Conceptual Alternatives Study</i></li> <li>• Update cost estimates</li> </ul>

**Table 40. ODOT's Major PDP Steps 5 through 14**

PDP Step and Key Engineering Components	Activities Performed During Step
Step 6	
Develop Feasible Alternatives	<ul style="list-style-type: none"> <li>• Develop feasible alternatives and preliminary construction limits</li> <li>• Perform field refinement environmental studies</li> <li>• Prepare Pre-National Environmental Policy Act (NEPA) document</li> <li>• Conduct first Value Engineering Study</li> <li>• Conduct first constructability review</li> <li>• Update cost estimates</li> </ul>
Step 7	
Develop Preferred Alternative	<ul style="list-style-type: none"> <li>• Recommend preferred alternative</li> <li>• Refine design plans for preferred alternatives</li> <li>• Submit Preferred Alternative Verification</li> <li>• Perform environmental field study/refine impacts</li> <li>• Prepare Waterway Permit Determination</li> <li>• Prepare and submit Categorical Exclusion (CE), Environmental Assessment (EA) or Draft Environmental Impact Statement (DEIS)</li> <li>• Develop detailed design scope of services</li> <li>• Update cost estimates and milestone dates</li> </ul>
Step 8	
Prepare Environmental Clearance/Develop Stage 1 Design	<ul style="list-style-type: none"> <li>• Finalize NEPA document (CE, EA or EIS)</li> <li>• Request Finding of No Significant Impact/Record of Decision/Categorical Exclusion approval</li> <li>• Develop and submit Stage 1 Detailed Design</li> <li>• Establish proposed right of way limits</li> <li>• Conduct second Value Engineering Study</li> <li>• Prepare Final Waterway Permit applications and conceptual mitigation plans</li> <li>• Update cost estimates</li> </ul>

**Table 40. ODOT's Major PDP Steps 5 through 14**

PDP Step and Key Engineering Components	Activities Performed During Step
Step 9	
Develop Stage 2 Design	<ul style="list-style-type: none"> <li>• Summarize environmental commitments and prepare necessary environmental plan notes</li> <li>• Prepare final mitigation plans</li> <li>• Develop and submit preliminary right of way plans</li> <li>• Develop and submit Stage 2 Detailed Design</li> <li>• Conduct second constructability review</li> <li>• Update cost estimates</li> </ul>
Step 11	
Develop Stage 3 Design	<ul style="list-style-type: none"> <li>• Develop and submit Stage 3 Detailed Design</li> <li>• Prepare Environmental Consultation Form</li> <li>• Update construction cost estimate</li> </ul>
Step 12	
Prepare Final Plan Package	<ul style="list-style-type: none"> <li>• Prepare and submit final tracings</li> <li>• Prepare and submit Final Plan Package</li> <li>• Update construction cost estimate</li> </ul>

## **6.2 Alternatives Description**

Two primary alignment concepts for the Brent Spence Bridge Replacement/Rehabilitation Project were evaluated in Step 5 and portions of Step 6. Both concepts utilize the existing alignment from Dixie Highway to KY 12<sup>th</sup> Street in Covington, Kentucky and from Ezzard Charles Drive to the Western Hills Viaduct in Cincinnati, Ohio. The Ohio River crossings and approaches to the main span utilize two different alignments to cross the river. These concepts are characterized as either “Queensgate alignment”, those located west of Longworth Hall through Queensgate, or “Existing alignment”, those located going east of Longworth Hall largely following the existing right of way.

The “Queensgate alternatives” have been reduced from Alternative A and B to one (Alternative B). The reasons for eliminating Alternative A from further study are presented in Section 2.4.1. Alternative B requires the acquisition of new right of way in northern Covington and through Queensgate in southwestern Cincinnati. Alternative B begins just north of KY 9<sup>th</sup> Street in Covington then veers northwest in a straight line from just south of the existing Brent Spence Bridge to the Ezzard Charles Drive overpass at Union Terminal. It rejoins the existing alignment of I-75 at Ezzard Charles Drive.

The “Existing alignments”, Alternatives C, D, E, and G are primarily located within the existing right of way throughout the current I-71/I-75 corridor from Dixie Highway to the Western Hills Viaduct. These alternatives extend through the southern terminus of the

Brent Spence Bridge through southwestern Cincinnati connecting to the existing alignment of I-75 and I-71 (Fort Washington Way).

Two primary alignment concepts were divided into four separate segments for project phasing and construction sequencing.

Segment 1 for all five conceptual alternatives begins south of Dixie Highway in Kentucky and extends north to approximately KY 9<sup>th</sup> Street in Covington. It is similar in concept and implementation approach for each of the conceptual alternatives. Access to Covington and the replacement or rehabilitation of the main spans and approaches of the Brent Spence Bridge constitute Segment 2 of the conceptual alternatives. Segment 2 begins at approximately KY 9<sup>th</sup> Street in Covington and extends north to Ezzard Charles Drive in Cincinnati. Segment 2 is the new bridge and connections for the Queensgate alignment. Segment 2 is the new bridge immediately adjacent to the existing Brent Spence Bridge for alignments in the existing interstate corridor. Segment 3 of the alternatives includes the I-71/I-75/US 50 Interchange, Cincinnati Central Business District access, and Queensgate access. Segment 4 begins at Ezzard Charles Drive and includes the mainline and collector-distributor (C-D) north of the I-71/I-75/US 50 Interchange. It extends north to the Western Hills Viaduct Interchange.

### **6.3 Project Phasing and Construction Sequencing**

The Brent Spence Bridge is part of the larger I-75 Improvement Program which extends from south of Dixie Highway in Kentucky to I-275 in Ohio. This program is subdivided into three major projects; the Mill Creek Expressway, the Thru the Valley project, and the Brent Spence Bridge. These Kentucky and Ohio projects are being developed under ODOT's Major PDP and will utilize phased construction. The Mill Creek Expressway will be constructed first, the Thru the Valley project will be constructed second, and the Ohio portion of the Brent Spence Bridge is third. Ohio may choose to complete portions of these other projects as the cost for the entire project areas may exceed current and foreseeable budgets. The construction sequencing for each of these programs of projects will need to be coordinated. Maintenance of traffic, lane continuity, and geometric design may dictate sensible construction termini that are different from the termini used for the planning and preliminary design efforts. Kentucky may begin its portion of the Brent Spence Bridge corridor at a different time due to budget constraints in Kentucky's Six-Year Transportation Plan. It is critical that phasing and connections of the main span with the Kentucky and Ohio approaches be coordinated between the two states. The delivery method should have a strong foundation in community awareness, maintenance of traffic, constructability, and safety.

Creative phasing allows for less complicated maintenance of traffic plans, while improving the interim performance and operational nature of the I-71/I-75 corridor. Building the entire Brent Spence Bridge corridor program in one phase would shorten the amount of time the public is affected; however, available funds may not permit this approach. Further refinements in the staging of the work will develop details of the phasing and funding plans, as well as coordination with the larger I-75 corridor. The integration and coordination of all I-75 construction projects is recommended.

#### **6.3.1 Construction Approach**

A constructability workshop was conducted by KYTC, ODOT, the City of Cincinnati, Federal Highway Administration (FHWA), Parsons Brinckerhoff, and the National

Constructor's Group on February 12, 2009, to evaluate the recommended construction approaches to the "Queensgate alignment" and "Existing alignment." As part of this workshop, Alternative E was selected as a representative "existing alignment" for review. Alternative E was chosen because Alternatives C, D, E, and G all have similar constructability issues. Documentation discussing the results of the constructability workshop is located in Appendix H. The constructability recommendations can be implemented in phases over an extended construction program, or built as part of a continuous construction process. The same general order is recommended irrespective of the extended construction or accelerated construction approach. Continuous operation of the interstate is assumed to be crucial with only short, non-peak hour closures for overpass construction or demolition. These improvements are divided into near term improvements and main line/main span improvements. The eventual recommendations for bridge and pavement type will be affected by the delivery and staging practice selected.

### **6.3.1.1 Near Term Improvements**

Near term improvements include:

- Construction of additional permanent lanes on I-471 between the Ohio River and I-275 in Kentucky with temporary resigning of I-71 onto I-471 to I-275 to I-71.
- Construction of an additional ramp lane between I-471 southbound to I-275 westbound.
- Construction of additional southbound lanes which double as truck lanes between KY 12<sup>th</sup> Street and Kyles Lane extending on to Dixie Highway in Kentucky.
- Construction of the C-D roadway/local street system in Kentucky from KY 12<sup>th</sup> Street to KY 4<sup>th</sup> and KY 5<sup>th</sup> streets in Covington.
- Construction of the C-D roadway in Kentucky from Dixie Highway and Kyles Lane.
- Construction of the C-D roadway north of the I-71/I-75/US 50 Interchange to Western Hills Viaduct Interchange.
- Construction of the Western Hills Viaduct Interchange.
- Final connection to the southern termini of the Mill Creek Expressway project.

Near term improvements will provide interim congestion relief, improve safety, and enhance operational performance of the system prior to complete reconstruction of the mainline and main river spans. Removing geometric deficiencies and implementing safety improvements will reduce congestion in the I-71/I-75 corridor. The construction of the C-D consolidates traffic into free flowing lanes onto the interstate and reduces the number of weaves. The C-D system is an important component of detours and controlled access points during other main line/main span improvements. These can be done before major mainline components of the work to improve interim performance prior to full reconstruction of I-75. They are also the least expensive of the components of the improvements, still required as part of the larger program, and provide intermediate improvements to congestion and safety at a lower initial cost. These can be completed while deferring the construction of the approaches and main span of the Brent Spence Bridge until funds become available.

### **6.3.1.2 Main Line/Main Span Improvements**

Main line/main span improvements include all of the main line improvements to the interstate and the overpasses associated with the I-71/I-75/US 50 Interchange. They also include any new main spans over the Ohio River, whether along the Queensgate alignment (Alternative B) or the existing corridor alignments (Alternatives C, D, E, and G). The mainline improvements connect to the main Ohio River span via the approach spans. The approach spans would be constructed with the main span.

### **6.3.1.3 Kentucky Collector-Distributor and Climbing Lanes**

The alternatives from Dixie Highway to the south end of the Brent Spence Bridge include a C-D/local ramp system between Dixie Highway and Kyles Lane, between KY 12<sup>th</sup> Street and KY 4<sup>th</sup> and KY 5<sup>th</sup> streets, and southbound climbing lanes between KY 12<sup>th</sup> Street to Dixie Highway. Additional climbing lanes on the southbound lanes of I-75, between KY 12<sup>th</sup> Street and Dixie Highway are recommended to allow for additional truck climbing capacity. Construction of the Kentucky C-D and climbing lanes will reduce congestion on the Brent Spence Bridge and on I-71/I-75 in the near term. The C-D utilizes existing right of way on the east and west of I-75. The C-D would combine the existing frontage roads that parallel I-75 northbound and southbound between KY 12<sup>th</sup> Street and KY 4<sup>th</sup> and KY 5<sup>th</sup> streets.

Trucks often occupy three of the four I-71/I-75 southbound lanes between KY 12<sup>th</sup> Street and Dixie Highway in Kentucky creating a rolling roadblock even during non-rush hour periods. Trucks create congestion on the hill as they attempt a side by side climb up the long hill. Enforcement of automobile only median lanes is necessary. Additional southbound climbing lanes between KY 12<sup>th</sup> Street and Dixie Highway would ease the rush-hour congestion.

### **6.3.1.4 Ohio Collector-Distributor and Western Hills Viaduct**

In Ohio, the C-D, Western Hills Viaduct, and mainline improvements north of the I-71/I-75/US 50 Interchange to the Western Hills Viaduct should be constructed first. The collector-distributor should be constructed first which allows the elimination and consolidation of certain ramps along I-75 between the I-71/I-75/US 50 Interchange and the Western Hills Viaduct. The C-D will utilize existing interstate right of way and excess Western and Winchell avenues rights of way east and west of the I-75 mainline. Widening of I-75 would be feasible by constructing retaining walls at the toe of the existing sloped embankments and the area filled for additional lanes for the mainline and for the C-D system. This construction can be performed without major detours or adverse impact to the main line of the interstate.

The construction of the Western Hills Viaduct Interchange must be the second phase of construction. This must occur before the mainline construction of the I-75 improvements at the north end of the Brent Spence Bridge project and the south end of the Mill Creek Expressway project. Bridge piers supporting the Western Hills Viaduct overpass are in the median of the existing alignment and conflict with the proposed new mainline alignment. The existing piers of the Western Hills Viaduct must be removed before the proposed mainline improvements can be made. The left hand exit in this area must be removed to improve safety and ease congestion prior to mainline construction. Detours for short term closures of the mainline will be able to use the C-D.



The interchanges at Western Hills Viaduct, Hopple Street and I-74/I-75 will require a coordinated phasing plan. These deficiencies can be corrected in early phases to provide improved access to Uptown and Western Hills and eliminate congestion related to geometric deficiencies.

#### **6.3.1.5 I-75 Mainline North of the I-71/I-75/US 50 Interchange**

The re-alignment and widening of the mainline of I-75 from north of the I-71/I-75/US 50 Interchange to the Western Hills Viaduct can occur any time after the C-D and the Western Hills Viaduct Interchange are constructed. The widened mainline can be constructed in areas vacated by the ramps and in the right of way currently occupied by the sloped embankments east and west of the I-75 mainline. Detours for short term closures of the mainline will utilize the C-D during placement of structural components. The north bound lanes can be constructed by putting northbound and southbound traffic on the southbound lanes, restriping the lanes to ten feet and redirecting trucks to other routes during peak hours. Once the northbound lanes are constructed, the traffic can be placed on the new northbound lanes while the southbound lanes are reconstructed. Overpasses and access ramps will be built as part of the mainline.

Coordination with I-75 mainline improvements north of the Western Hills viaduct is recommended.

#### **6.3.1.6 I-71/I-75/US 50 Interchange**

Construction of the I-71/I-75/US 50 Interchange and local access to downtown Cincinnati should be conducted in a phased approach. Construction of the I-75 mainline in Ohio requires coordination with construction of the main span of the new Ohio River Bridge. This requires that some overpasses and the ramps between US 50 and I-71/I-75 be completed prior to the mainline construction to allow removal of bridge piers out of the construction zone of the mainline. Due to the complexity of this interchange, phasing must be included in the design of all components. This will ensure that bridge spans and piers for the mainline, interchange ramps, and local access works at each stage of construction.

It is recommended that through traffic along I-71 be rerouted to I-471 and I-275 in Kentucky, which would be widened during the near term improvement phase. This reserves maintenance of traffic lanes for I-75 and its heavy truck components.

#### **6.3.1.7 Alternative B - Queensgate Alignment**

For the Queensgate alignment, I-71/I-75 mainline and C-D improvements in Kentucky south of the south abutment of the Brent Spence Bridge are similar to those for other conceptual alternatives. Improvement to the I-71/I-75/US 50 Interchange would proceed before construction of the river span as previously described. Construction of the C-D along I-75 to Western Hills Viaduct could proceed as described previously. Since the Queensgate alignments diverge from existing I-71/I-75 right of way, construction of the mainline through Queensgate would occur without significant interruption to interstate traffic, except where the interchanges and mainline connect to the I-71/I-75/US 50 Interchange.

The construction of the Queensgate alignment requires advance relocation of the high voltage transmission lines crossing the river. These lines belong to Duke Energy and add complexity to this alternative. Duke Energy determined that utility relocations for

Alternative B would include four overhead transmission lines consisting of three 138 kilovolt (KV) circuits and one 69 KV circuit. These interfere with the new bridge over the Ohio River at various locations. Two transmission lines, one 138 KV circuit and one 69 KV circuit, interfere with the approach spans. The high voltage lines must be relocated and energized before the existing lines are removed. This requires new utility right of way for construction. Duke Energy completed a cost analysis, a preliminary design, and constructability study for the lines relocation. Design of this relocated system is beyond the scope of this study. However, Duke Energy would design and build the relocated network prior to construction of I-75. This includes engineering the new system, acquisition of right of way for the lines, clearing the right of way of structures, constructing the new towers, building and stringing the cables, and demolishing the existing system. Relocation or modification of the west end substation and four transmission lines consisting of two overhead 138 KV circuits and two underground 138 KV circuits is required by the existing alignment alternatives (Alternatives C, D, E, and G). All utility relocations must occur before construction of the new Brent Spence Bridge occurs.

Construction of Alternative B would begin with right of way acquisition during design of the mainline improvements. This would include aerial easements and fee simple ownership because much of this alignment would be on structure. Utility relocations will need to be designed and built by Duke Energy in new right of way. This includes the acquisition of right of way for the high voltage transmission lines. Right of way for this utility might be acquired by KYTC and ODOT using available negotiation approaches or eminent domain. Coordination with the railroad regarding the rail crossings is required for Alternative B and would occur before the NEPA process is complete.

Construction of the interstate would begin after design and right of way acquisitions are fully complete. Once required right of way and easements are acquired, demolition of the buildings in the Queensgate alignment would occur, including all localized utility relocations. The relocation of the high level transmission lines requires the construction of the replacement system including any workarounds, prior to taking the existing service off line. Maintenance of traffic will be required at each city street intersection and at the mainline connections south of Brent Spence Bridge and at Ezzard Charles Drive.

#### **6.3.1.8 I-75 Mainline**

Construction of the I-75 mainline would proceed in segments once the C-D systems in Kentucky and Ohio are constructed and most of the overpasses bridge piers have been relocated. The mainline construction near the new main span should be built with the main span as the grades and alignments must meet. While this is a substantial portion of the work, the right of way is wide in most places and provides for ample space for detours, temporary pavements, and added lane capacity during construction. Local access would be limited in order to provide unfettered travel for the interstate mainline traffic. Local traffic would be detoured prior to each end of the construction zones. Coordination with I-75 projects north of the Western Hills Viaduct is recommended.

#### **6.3.1.9 Main Span Construction**

The construction of the main span of the new Ohio River Bridge is a challenging component of the I-75 program, irrespective of which alternative is chosen. The existing alignment of the Brent Spence Bridge has right of way constraints associated with the Duke Energy power station on the west, utilities under the Ohio River on the east,

historic structures and cultural resources near the alignment, and existing businesses. Maintenance of traffic during the construction of supplemental structures will be complex. The constructability program for the bridge replacement must assume that the existing Brent Spence Bridge will remain operational before, during, and after, the supplemental replacement capacity is put into service. Alternatives which include rehabilitation of the existing bridge are also complex as the existing bridge must be kept in service during any rehabilitation. The Queensgate main span alignment would provide alternate maintenance of traffic during construction because the new main span will be constructed on a new alignment. Existing capacity would not be impaired except during rehabilitation of the existing bridge, and construction of the I-71/I-75/US 50 Interchange.

The main span concept for Alternative B is complicated by a skewed alignment across the Ohio River. This creates sailing line impacts for commercial river traffic and creates sight distance concerns for river traffic. The skewed alignment also requires increased span lengths and more complicated bridge types. The proposed alignment for Alternative B is skewed 30 degrees from the sailing axis of the Ohio River. The alignment also crosses the Ohio River at a point where it bends to the north. This further complicates sight distance compliance on the river for commercial traffic. In order to provide for safe commercial shipping through the seven bridge system connecting southwest Ohio with Northern Kentucky, bridge pier locations will be on or near shore. This creates a longer span length for a skewed bridge, increasing its cost and limiting the number of bridge types that might be considered for the Ohio River crossing. These issues are not insurmountable, but simply add cost and construction complexity to the main span of the bridge for the Queensgate alignment. Geotechnical information generated during the *Planning Study Report* indicates deep deposits of sediment over limestone bedrock. Long span lengths and bridge types requiring deep foundations and anchorages will require large and deep excavations for the Queensgate alignment.

The existing alignments (Alternatives C, D, E, and G) that utilize all or part of the existing I-71/I-75 Brent Spence Bridge main span have complexities as well. These are related to right of way, maintenance of traffic, and constructability. They arise from construction of major improvements in existing right of way while keeping portions of the interstate operational. The rehabilitation of the existing structure would be retained in all of the alternatives as part of a final build solution. A maintenance of traffic and construction plan that includes a rehabilitated Brent Spence Bridge with new structures or structures with the existing system is complicated by the double decked nature of the existing span.

#### **6.3.1.10 Continuous Design Constructability Interface**

The development of the conceptual alternatives proposed for either the Queensgate alignment (Alternative B) or the existing alignment (Alternative C, D, E, and G) should incorporate a continuous design constructability plan. This means that the corridor design and bridge types selection (main, approach and interchange spans) are developed with significant consideration for maintenance of traffic and constructability. Construction phasing, technique, construction type, and capacity during construction will pose significant constraints on how the program is implemented. Constructability constraints may dictate the type and size of the bridges. Therefore, the construction delivery plan should be integrated continuously into the design development. This extends beyond the value engineering process conducted at the 30/60/90 percent design phases.

## **6.4 Financial Strategy**

Funding for the Brent Spence Bridge Replacement/Rehabilitation Project will be provided from federal and state sources. Funding for each phase will use the appropriate Federal Fund Types with the eligible federal pro-rata share. This project will be subject to the Federal Highway's (FHWA) Major Project requirements. The Project Management Plan (PMP) would be prepared jointly by KYTC and ODOT for their respective portions of the project. A coordination plan for each States' responsibilities under the PMP is recommended.

The Financial Plan for Brent Spence Bridge Replacement/Rehabilitation Project answers the following questions:

- What funds are realistically available?
- What timeframe restrictions apply?
- What approval process is required?
- What other restrictions apply?

### **6.4.1 National High Priority Corridor Financial Listings**

The Intermodal Surface Transportation Efficiency Act of 1991 (ISTEA) identified High Priority Corridors on the National Highway System (NHS). Among these corridors are I-75 from Toledo to Cincinnati and I-71 between Columbus and Cincinnati. More recent federal surface transportation legislation (the 1998 Transportation Equity Act for the 21<sup>st</sup> Century [TEA-21] and the 2005 Safe, Accountable, Flexible, Efficient Transportation Equity Act: A Legacy for Users [SAFETEA-LU]), continued funding for the High Priority Corridors. The Brent Spence Bridge Replacement/Rehabilitation Project is part of several of these corridors, including I-71, I-75, and the I-74 corridor. It also connects to the Waldvogel Viaduct in Queensgate. Table 41 summarizes federal funding identified in SAFETEA-LU for High Priority Projects in the Greater Cincinnati/Northern Kentucky region.

**Table 41. High Priority Projects Listed Under SAFETEA-LU Located in or near the Brent Spence Bridge Replacement/Rehabilitation Project**

<b>Item Number*</b>	<b>State</b>	<b>Project Description</b>	<b>Amount</b>
685	OH	Study and design of modifications to I-75 interchanges at Martin Luther King, Jr. Boulevard, Hopple Street, I-74, and Mitchell Avenue in Cincinnati	\$2.4 million
3385	KY	Replace Brent Spence Bridge, Kenton County	\$1.6 million
4217	KY	Transportation improvements to Brent Spence Bridge	\$34 million
4621	OH	On I-75 toward Brent Spence Bridge, Cincinnati	\$10 million

**Table 41. High Priority Projects Listed Under SAFETEA-LU Located in or near the Brent Spence Bridge Replacement/Rehabilitation Project**

Item Number*	State	Project Description	Amount
4623	OH	Reconstruction, widening, and interchange upgrades to I-75 between Cincinnati and Dayton	\$5 million
4624	OH	Replace the Edward N. Waldvogel Viaduct, Cincinnati, (US Route 50)	\$6 million

\* Legislative project number

#### **6.4.2 Financial Plan**

The Commonwealth of Kentucky and State of Ohio have appropriated money for the preliminary engineering and environmental documentation for the Brent Spence Bridge. Each State is responsible for their portion of the project separated by the State Line (N39° 05.516'/W84° 31.324 +/-). The obligation to pay for the improvements to the Brent Spence Bridge to (N39° 05.516'/W84° 31.324 +/-) is well established. Financial obligations are defined in the Bi-State Agreement authorizing this work. The Bi-State Agreement estimated that the cost of the environmental and preliminary design phase of the project would be \$18 million. Additionally, the agreement states that ODOT will pay 46.8 percent of the cost based on ownership of the project as defined by state lane miles. KYTC has agreed to pay 53.2 percent of the estimated cost. The project limits have been extended from Kyles Lane to Dixie Highway in Kentucky. The project limits were extended to Dixie Highway Interchange due to anticipated mainline work south through the Kyles Lane Interchange. This will affect the percentage of the costs attributable to each state. Additional phases of work required during or after the environmental and preliminary design phase, including but not limited to, preliminary design, detailed design, right-of-way acquisition, utility relocation, and construction will be covered under future supplements to the agreement. The Financial Plan for Kentucky and Ohio is presented in the responses to following four questions.

#### **What funds are realistically available?**

**Kentucky:** Kentucky received federal fund earmarks totaling \$35.6 million through SAFETEA-LU. These earmarks flow to the Commonwealth in a formula as prescribed by SAFETEA-LU. The rate currently in effect is 20 percent per year from fiscal year (FY)-2005 through FY-2009. According to this formula, 100 percent of the SAFETEA-LU funding (FY 2005/FY 2009) should be available. Prior year, federally earmarked funds are already authorized in the amount of \$1.16 million. Supplemental funding authorization in progress added \$2.64 million of federally earmarked money. The total amount currently available from Kentucky is \$39.4 million. Toll revenue credits will be used to match these federal funds. The federal appropriation will constitute immediate, short-range commitment to the project for design and acquisition of required right of way in Kentucky.

**Ohio:** ODOT has been authorized to spend \$29 million as part of the total TRAC commitment. The funds were made available in January 2005. These funds are already programmed and available. Other funds have been authorized for ancillary studies in the study area.

A total of \$68.4 million is available for project development costs prior to right of way acquisition. Right of way and construction costs have not been authorized or appropriated.

**What time frame restrictions apply?**

**Kentucky:** The available federal funds will be applied to design, right of way acquisition, and utility relocation efforts. Coordination with Ohio's plan to begin design, right of way acquisition, and any near term improvements will be required.

**Ohio:** Ohio's Transportation Review Advisory Council (TRAC) schedules the availability of preliminary development and detailed design funds. Construction is expected to begin after the completion of I-75 construction north of the study area. ODOT has established a plan for upgrading I-75 from the north abutment of the Brent Spence Bridge to north of I-275. This plan has three major components: first, the Mill Creek Expressway; second Thru the Valley; and third, the Brent Spence Bridge.

The Transportation Bill reauthorization will determine the availability of high priority federal-aid funds for construction. Ohio has appropriated \$18 million for preliminary engineering and environmental documentation. These funds were available to the project in 2005 and are intended to be used by 2010.

The next federal bill will determine the level of federal funds available for right of way acquisition and construction.

**What approval process is required?**

**Kentucky:** Any funding authorizations, scope changes, change orders, or other cost or schedule adjustments must be approved by the Secretary of Transportation and Commissioner of Highways. Additional state appropriation will require legislative action.

**Ohio:** TRAC will need to approve all additional Major New commitments.

**What other restrictions apply?**

**Kentucky:** Funding availability for KYTC is a function of a legislatively approved Six-Year Transportation Plan. Each even-numbered calendar year, the Kentucky General Assembly approves the upcoming biennial element of the Six-Year Transportation Plan. Kentucky's ability to advance funding from future years to the new biennium is limited. Appropriately timed funding for the Brent Spence Bridge Replacement/Rehabilitation Project will require close coordination with KYTC and may require the use of Grant Anticipation Revenue Bonds (GARVEE) to match the funding stream with right of way and construction schedules. Biennial Six-Year Transportation Plan updates are developed late in odd-numbered years preceding legislative sessions. Coordination requirements with the Metropolitan Planning Organization's Transportation Improvement Programs (TIP) and Long Range Transportation Plan, as well as the Kentucky and ODOT State Transportation Improvement Programs (STIPs) will be required. The issue of tolls has been discussed but not evaluated as part of this study.

**Ohio:** Following Step 8 of the Major PDP, the administration of design development contracts, acquisition of rights of way, and construction contracts may be held separately by the states. Ohio will complete sections north of (N39° 05.516'/W84° 31.324 +/-). Kentucky will complete sections south of (N39° 05.516'/W84° 31.324 +/-). The programs will be coordinated.

The Financial Plan for Brent Spence Bridge Replacement/Rehabilitation Project is summarized in Table 42.

**Table 42. Financial Plan for Brent Spence Bridge Replacement/Rehabilitation Project**

Project Phase	Funding Source	2005	2006	2007	2008	2009	2010	2011	2012-2014	2015
<b>Ohio</b>										
Preliminary Engineering	TRAC	\$250,000	\$128,194	\$229,435	\$49,873	\$531,523	\$1.38 million			
	SAFETEA-LU \$9.1 million	20%	\$1.15 million	\$2.06 million	\$448,864	\$3.36 million	\$546,028			
	Local						\$60,669			
Final Design	TRAC							\$25 million		
Right of Way*									Unfunded	
Construction**										Unfunded
<b>Kentucky</b>										
Preliminary Engineering	Earmarks \$1.16 million \$2.64 million SAFETEA-LU \$35.6 million	20%	20%	20%	20%	20%				
Final Design		20%	20%	20%	20%	20%	20%	20%		
Right of Way*		20%	20%	20%	20%	20%			Unfunded	Unfunded
Construction**									Unfunded	Unfunded

Notes:

\*Right of Way acquisition for the roadway improvements is currently estimated at \$100 million. It is assumed that right of way would be funded with a combination of federal earmarks, federal and state funds, following TRAC approval in Ohio. Acquisition will occur over a two to three year period.

\*\*Construction funds would be necessary in 2015 at the earliest. It is assumed that construction would be funded with a combination of federal earmarks, federal and state funds.



### **6.4.3 Estimated Costs for Conceptual Alternatives**

The 2008 construction cost estimates were prepared as outlined by ODOT's *Procedure for Construction Budget Estimating* (January 2008) and by use of the Transport Estimator, Version 2.3a, with March 2008 catalogs. The mid-point of construction year 2017 was assumed for inflation and based upon a letting year of 2015.

The inflation cost percentage was calculated as outlined by ODOT's *Procedure for Construction Budget Estimating* (January 2008) utilizing the FY08'-09' Business Plan Inflation Calculator (July 2008). For the inflation cost percentage calculations, the date of November 1, 2008 was used for the Estimation Start Date and June 1, 2017 was used for the Construction Mid-Point Date. Based on these dates, the semi-annually compounded growth inflation cost percentage was calculated to be 59.5% for the project. The inflation cost percentage is noted as Contingency on the cover page of the cost estimates in Appendix D as per the ODOT's procedures.

For quantity takeoff purposes, the project corridor was divided into five segments consisting of two segments in Kentucky (Segments 1 and 2), Ohio River crossing (Segment 3), and two segments in Ohio (Segments 4 and 5).

The conceptual roadway design for Segment 1 is the same for all conceptual alternatives which extends from the southern project limits south of Dixie Highway Interchange to just south of the KY 12<sup>th</sup> Street ramps.

Segment 2 limits extend from just south of the KY 12<sup>th</sup> Street ramps to the south abutments of the Ohio River main span bridges. Segment 2 was separated into the following grouping of alternatives:

- Alternative B;
- Alternatives C and D;
- Alternative E; and
- Alternative G.

Segment 3 consists of the main span bridges over the Ohio River and the rehabilitation of the existing Brent Spence Bridge. Segment 3 was separated into the following groupings of alternatives:

- Alternative B;
- Alternatives C, D, G; and
- Alternative E.

Segment 4 limits extend from the north abutments of the Ohio River main span bridges to just south of the Ezzard Charles Drive. Segment 4 was divided into the following grouping of alternatives:

- Alternative B;
- Alternatives C and D;
- Alternative E; and
- Alternative G.

Segment 5 limits are just south of Ezzard Charles Drive to the northern projects limits. Segment 5 was separated into the following grouping of alternatives:

- Alternative B;
- Alternatives C and D;
- Alternative E; and
- Alternative G.

The estimated quantities were calculated by manual take-offs from scale drawings and electronic CADD files utilizing plans and the associated cross sections of each conceptual alternative. The number of new lanes and shoulders determined the proposed work limits. In transition areas where the number of lanes changes, the cross sections were averaged and multiplied by the distance between the stations where the cross sections begin and end. The numbers of existing lanes and shoulders were counted to determine the demolition quantities. Each alternative was reduced into the item numbers and cost item descriptions from the current ODOT Construction Estimator database. Preliminary quantities or allowances were used to develop the conceptual cost estimates. The unit prices and quantities for each alternative are shown in Appendix D.

#### **6.4.3.1 Utility Costs**

The costs for utility relocations will be calculated by KYTC District 6 and ODOT District 8 and added to the utility cost estimates. As a supplement to ODOT calculations of utility costs, the Project Team has been in close coordination with Duke Energy regarding their facilities located along the western side of the I-71/I-75 corridor. As a result of this coordination, Duke Energy completed an initial assessment of the costs and relocation impacts for each of the conceptual alternatives. The costs prepared by Duke Energy are based on 2008 construction costs and are not based on detailed engineering plans or actual construction bids. Duke Energy historical escalation rates over the past three years have been 30 percent per year and they anticipate future escalation rates to be 15 percent per year. Duke Energy's cost estimates for the conceptual alternatives have not been adjusted for inflation and are based on letters received from Duke Energy dated April 11, 2008, June 24, 2008, and January 30, 2009:

- Alternative B
  - \$24,000,000 to \$67,000,000 (letters dated April 11, 2008 and June 24, 2008)
  - \$100,000,000 (letter dated January 30, 2009)
- Alternative C, D, E, and G
  - \$22,500,000 (letters dated April 11, 2008 and June 24, 2008)

These costs do not include any betterment nor are any right of way costs included. Duke Energy has expressed interest to KYTC and ODOT in assisting with the purchase of new right of way that would be required for them to relocate their infrastructure. In correspondence dated January 30, 2009, Duke Energy estimated five acres would need to be purchased on the north side of the Ohio River, west of the new bridge and one to two acres on the south side of the Ohio River to build new substations to transition high voltage circuits from overhead to underground cable (Appendix H).

The utility costs in Table 45, Table 46, and Table 47 are based on the highest estimated costs for each alternative and was adjusted for 15 percent inflation compounded to year 2012. The overall utility cost for each alternative was then split equally between KYTC

and ODOT. For Alternative B, the adjusted cost estimates ranged from \$42.0 to \$175.0 million. For Alternative C, D, E, and G, the adjusted cost estimate was \$39.4 million.

The real estate utility costs in Table 45, Table 46, and Table 47 are based on the estimated average cost of land in the Queensgate corridor being \$1,000,000 per acre. For Alternative B, it was determined five acres in Ohio and two acres in Kentucky were needed. For Alternative C, D, E, and G, it was estimated one acre would be needed. The overall real estate utility cost for each alternative was then divided equally between KYTC and ODOT.

**6.4.3.2 Real Estate and Relocation Cost Development**

Real property values utilized for this cost estimate were developed based upon appraised value indications from the Hamilton County Auditor’s (Ohio) and Property Valuation Administrator’s (Kentucky) records in the appropriate jurisdictions. The assessed value for properties in Kentucky is for 2008 while Ohio values are from 2005. These are not detailed cost estimates and should be used for comparison purposes only. The cost estimates are not of sufficient detail to be used for acquisition estimates, but are used as a benchmark to prepare the relative real estate costs between the conceptual alternatives. No actual appraisals were conducted. All valuations were created using readily available tax records. No entry to the property was allowed. Relocation costs were not included in this estimate since information was not provided for the majority of the study area during technical studies.

Table 43 presents the estimated right of way costs for the conceptual alternatives. A consumer price index was used to project costs to 2012 which is the anticipated year for acquisition. An inflation factor was not applied to the real estate costs.

**Table 43. Real Estate Costs (2012) (in millions)**

Mainline Alternative	Ohio	Kentucky
	Valuation with CPI <sup>1</sup>	Valuation with CPI <sup>1</sup>
Alternative B	\$46.5	\$18.4
Alternative C	\$15.5	\$2.5
Alternative D	\$12.1	\$2.4
Alternative E	\$13.0	\$2.4
Alternative G	\$19.9	\$4.6

1- Consumer Price Index (CPI) factor of 15.8 percent

**6.4.3.3 Project Development Costs**

In order to completely include all project costs in the estimates, project development costs, which consist of preliminary engineering and environmental documentation, detailed design, and construction management, are included. The current preliminary engineering and environmental documentation participation split is 53.2 percent for KYTC and 46.8 percent for ODOT. The participation split is only applied to the preliminary engineering and environmental documentation cost of \$18 million. The detailed design cost is calculated to be 8 percent of the construction cost (2008 dollars) adjusted for 3 percent inflation compounded to year 2012. The construction management cost is calculated at 3 percent of the construction cost including inflation (2017 dollars) adjusted for 3 percent inflation compounded to year 2017. Table 44 summarizes the project development costs.

**Table 44. Project Development Costs (in millions)**

Alternative	Preliminary Engineering/ Environmental Documentation	Detailed Design (8% of Construction Year 2008 Cost) <sup>1</sup>	Construction Management (3% of Construction Year 2017 Cost) <sup>2</sup>	Total Project Development Costs
Alternative B	\$18.0	\$133.6	\$92.6	\$244.2
Alternative C	\$18.0	\$113.6	\$78.8	\$210.4
Alternative D	\$18.0	\$113.6	\$78.8	\$210.4
Alternative E	\$18.0	\$128.9	\$89.4	\$236.3
Alternative G	\$18.0	\$134.7	\$93.3	\$246.0

1- Includes 3 percent inflation compounded to year 2012

2- Includes 3 percent inflation compounded to year 2017

#### 6.4.3.4 Contingencies and Reserves

ODOT guidelines require the use of a contingency on construction cost estimates. A contingency of 25 percent was added to the construction costs to reflect the preliminary nature of engineering. The design contingency for each conceptual alternative is included in the construction costs shown in Table 45, Table 46, and Table 47.

#### 6.4.3.5 Complete Project Costs

The total estimated project costs are construction costs which include a design contingency, a construction inflation factor, right of way for roadway and utility relocations, major utility, and total project development costs. Table 45 and Table 46 summarize total estimated project costs of each alternative for Kentucky and Ohio respectively. Table 47 summarizes combined total estimated project costs. The associated costs for the main span bridges over the Ohio River were added to the Kentucky cost estimates.

**Table 45. Total Cost Estimates for Mainline Alternatives (Kentucky) in Projected Build Year dollars**

Alternative	Construction Costs (millions)	Construction Costs Inflation (59.5%) (millions)	Real Estate Costs (millions)	Utility Costs <sup>1</sup> (millions)	Real Estate Utility Costs (millions)	Project Development Costs (millions)	Total Estimated Costs (millions)
Alternative B	\$931.3	\$554.1	\$18.4	\$87.5	\$3.5	\$151.6	\$1,746.4
Alternative C	\$790.2	\$470.2	\$2.5	\$19.7	\$0.5	\$130.1	\$1,413.2
Alternative D	\$790.2	\$470.2	\$2.4	\$19.7	\$0.5	\$130.1	\$1,413.1
Alternative E	\$924.2	\$549.9	\$2.4	\$19.7	\$0.5	\$150.5	\$1,647.2
Alternative G	\$818.4	\$486.9	\$4.6	\$19.7	\$0.5	\$134.4	\$1,464.5

1- Based on Duke Energy highest estimates dated June 24, 2008 and January 30, 2009. Includes 15 percent inflation compounded to year 2012, split equally between KYTC and ODOT. Cost does not include other major utilities costs to be estimated by ODOT. For Alternative B, the adjusted cost estimates ranged from \$21.0 to \$87.5 million from KYTC.

**Table 46. Total Cost Estimates for Mainline Alternatives (Ohio) in  
Projected Build Year dollars**

Alternative	Construction Costs (millions)	Construction Costs Inflation (59.5%) (millions)	Real Estate Costs (millions)	Utility Costs <sup>1</sup> (millions)	Real Estate Utility Costs (millions)	Project Development Costs (millions)	Total Estimated Costs (millions)
Alternative B	\$552.1	\$328.5	\$46.5	\$87.5	\$3.5	\$92.6	\$1,110.7
Alternative C	\$471.5	\$280.5	\$15.5	\$19.7	\$0.5	\$80.3	\$868.0
Alternative D	\$471.5	\$280.5	\$12.1	\$19.7	\$0.5	\$80.3	\$864.6
Alternative E	\$507.4	\$301.9	\$13.0	\$19.7	\$0.5	\$85.8	\$928.3
Alternative G	\$676.7	\$402.6	\$19.9	\$19.7	\$0.5	\$111.6	\$1,231.0

1- Based on Duke Energy highest estimates dated June 24, 2008 and January 30, 2009. Includes 15 percent inflation compounded to year 2012, split equally between KYTC and ODOT. Cost does not include other major utilities costs to be estimated by ODOT. For Alternative B, the adjusted cost estimates ranged from \$21.0 to \$87.5 million for ODOT.

**Table 47. Total Cost Estimates for Mainline Alternatives (Combined) in  
Projected Build Year dollars**

Alternative	Construction Costs (millions)	Construction Costs Inflation (59.5%) (millions)	Real Estate Costs (millions)	Utility Costs <sup>1</sup> (millions)	Real Estate Utility Costs (millions)	Project Development Costs (millions)	Total Estimated Costs (millions)
Alternative B	\$1,483.4	\$882.6	\$64.9	\$175.0	\$7.0	\$244.2	\$2,857.1
Alternative C	\$1,261.7	\$750.7	\$18.0	\$39.4	\$1.0	\$210.4	\$2,281.2
Alternative D	\$1,261.7	\$750.7	\$14.5	\$39.4	\$1.0	\$210.4	\$2,277.7
Alternative E	\$1,431.6	\$851.8	\$15.4	\$39.4	\$1.0	\$236.3	\$2,575.5
Alternative G	\$1,495.1	\$889.5	\$24.5	\$39.4	\$1.0	\$246.0	\$2,695.5

1- Based on Duke Energy highest estimates dated June 24, 2008 and January 30, 2009. Includes 15 percent inflation compounded to year 2012, split equally between KYTC and ODOT. Cost does not include other major utilities costs to be estimated by ODOT. For Alternative B, the adjusted cost estimates ranged from \$42.0 to \$175.0 million.

## 6.5 Actions and Next Steps

### 6.5.1 Implementation Team

During Steps 1 through 4 of the project, KYTC and ODOT instituted two committees which help provide guidance to the Project Team. One committee, the Advisory Committee, provides input from local community and political leaders in order that the project can provide and have some local community input. This also provides an opportunity for important issues brought up to the Advisory Committee to be

communicated back to the constituencies represented by the members of this committee. It is recommended that this committee remain active during subsequent phases of the work.

The second committee, the Aesthetics Committee, is a sub-committee of the Advisory Committee. This sub-committee provides local input on the design and aesthetic appearance of the corridor and the main span of the Brent Spence Bridge. As the project evolves, more detail is being provided to and from this committee in order to give some input on community values with respect to the aesthetics of the bridge. It is recommended that this committee remain active during subsequent phases of the work.

### **6.5.2 Public Involvement**

Public involvement is a key component of this project. This ensures that the public is aware of the alternatives that may be recommended and has an opportunity to provide input as users of the facility during the design development and environmental process. This project will have an impact on the community in terms of construction as well as economic development and socio-economic impacts. Because of the nature and magnitude of the project, these impacts should afford communities the right to comment and provide input on final implementation strategies and construction impacts.

The public involvement and public education process must provide an effective and efficient means of communicating to the public. Conversely, by giving the public an opportunity to communicate with the transportation agencies, public support will follow. The public involvement process is a requirement of NEPA and SAFETEA-LU. Addressing community concerns and incorporating community input into the design and construction of the project is critical. This includes everyone from local residents to the governing councils of the various cities associated and affected by the project. These individuals have a requirement to communicate to the Project Team as well as to communicate Project Team information back to the contingencies that they represent.

#### **6.5.2.1 Media Relations**

The media has provided positive support and accurate communication about the Brent Spence Bridge Replacement/Rehabilitation Project. It has been front page news a number of times primarily because of the scale and magnitude of the project. The coverage of the conceptual alternatives and potential design concepts for the project has been moderate. However, the announcement of the recommended conceptual alternatives for the project generated a significant amount of media interest. It is anticipated that when the next phase of the project begins, media relations will be maintained in order to provide information to the media so they can help communicate any messages that are important in eliciting community response. It is recommended that editorial briefings for important media and newspaper outlets in the two states be an important part of the media communications. Daily contact with reporters asking questions can be maintained by KYTC and ODOT.

## **6.6 Schedule**

The following is the schedule for the Brent Spence Bridge Replacement/Rehabilitation Project, which follows construction of the Mill Creek Expressway and Thru the Valley projects.

- Completion of preliminary design and NEPA process – 2010
- Detailed design - 2011
- Right of way acquisition – 2012 - 2014
- Construction begins – 2015

## **7.0 CONCLUSIONS AND RECOMMENDATIONS**

At the end of Step 4 of the Ohio Department of Transportation's (ODOT) Project Development Process (PDP), a total of six conceptual alternatives, the No Build alternative and five mainline build alternatives were recommended for further study in Step 5. The five mainline alternatives and sub-alternatives were further developed in more detail and refined during Step 5 of the PDP. These efforts included environmental studies, traffic analysis, refinement of horizontal and vertical alignments, cost estimates, utilities coordination, and stakeholder coordination. As a result, the mainline alternatives and sub-alternatives from Step 4 as presented in the *Planning Study Report* (September 2006) evolved into eight conceptual alternatives. The conceptual alternatives developed and evaluated in Step 5 all have similar impacts at both the southern and northern ends of the study area. Distinction among the alternatives is made by evaluating the impacts of each within the Central Business Districts (CBD) and adjacent communities of both Covington, Kentucky and Cincinnati, Ohio. The difference between the conceptual alternatives is the area between the limits of KY 12<sup>th</sup> Street and Ezzard Charles Drive.

Alternative B "Queensgate alignment" is west of Longworth Hall through the Queensgate area. Alternatives C, D, E, and G "Existing alignment" are all alignment variations which follow the existing interstate corridor. Environmental impacts and 2035 levels of service are similar for all conceptual alternatives. Among these alternatives, access to both CBD areas varies from providing direct access via new interchanges with I-71/I-75 to providing CBD access with a system of collector-distributor (C-D) roadways that connect to CBD access points.

The Conceptual Alternatives Evaluation Matrix, which is located at the end of this section, provides a summary of impacts of the No Build Alternative and each conceptual alternative. The following sections present summary discussions of the No Build Alternative, each conceptual alternative, and recommendations for feasible alternatives to be carried forward and studied in Step 6 of the PDP.

### **7.1 No Build Alternative**

The No Build Alternative is retained as a baseline for evaluation of the conceptual alternatives. The No Build Alternative consists of minor, short-term safety and maintenance improvements to the Brent Spence Bridge and I-75 corridor, which would maintain continuing operations.

The No Build Alternative does not address any of the Purpose and Need elements. It would not improve traffic flow and level of service, improve safety, correct geometric deficiencies, or improve connections to key local, regional, and national transportation corridors. Because the No Build Alternative would not correct the geometric deficiencies that currently exist throughout the corridor, congestion would continue to worsen, causing traffic flow problems. Additionally, safety concerns would remain since the

areas that have high crash rates would not be improved. Most segments of the No Build Alternative would have a failing level of service (LOS) (E or F) in 2035 or sooner. While the No Build Alternative would allow for existing connections to local, regional and national transportation corridors to be maintained, these connections would not be upgraded to current design standards, and therefore would leave the majority of ramp connections with a failing level of service.

No additional right of way is needed for the No Build Alternative. The No Build Alternative does not impact any wetlands, streams, woodlots, or threatened and endangered species. The Ohio River is not impacted by this alternative. The No Build Alternative would not impact cultural or Section 4(f) resources.

The No Build Alternative would not impact community cohesion and community resources. The No Build Alternative would not impact any social clusters in the study area. The No Build Alternative would not have an effect on environmental justice populations. Land use would remain unchanged and future land use plans would not be affected with the No Build Alternative. The No Build Alternative would not result in any residential, business, or utility displacements. The No Build Alternative would not change any patterns or accessibility.

The No Build Alternative would have noise impacts in both Kentucky and Ohio. In 2035, noise levels for the No Build Alternative will approach or exceed the Noise Abatement Criteria (NAC) of 66 dBA (Category B) at all receptor locations in Kentucky and Ohio. Noise levels for the No Build Alternative will approach or exceed the NAC of 71 dBA (Category C) at all but six noise receptors in Kentucky. In Ohio, all but eight receptors will approach or exceed the FHWA NAC of 71 dBA.

No public or agency comments in support of the No Build Alternative have been received to date.

There are no right of way acquisition or construction costs associated with the No Build Alternative.

## **7.2 Alternative B**

Alternative B is the former Alternative 2, I-71/US 50 Interchange Sub-Alternative 2, Hybrid of Collector-Distributor Roads Sub-Alternative 1 and Arterial Improvements Sub-Alternative 2 from the *Planning Study Report*. It is also known as the “Queensgate alignment”. Alternative B is different from the conceptual Alternatives C, D, E, and G between the limits of KY 12<sup>th</sup> Street and Ezzard Charles Drive. Alternative B south of KY 12<sup>th</sup> Street has six lanes northbound and six lanes southbound. Access into Covington will be provided by a C-D roadway which will connect to the existing Brent Spence Bridge. A new bridge will be constructed west of the existing Brent Spence Bridge for I-71/I-75 traffic. The new bridge will be approximately 900 feet west of the existing bridge on a skew across the river. This new alignment passes through the Queensgate area of Cincinnati and reconnects to the existing I-75 alignment near Ezzard Charles Drive. I-71/I-75 consists of four lanes in each direction within Kentucky. Both I-71 and I-75 will consist of two lanes in each direction in Ohio. US 50 will be realigned in Ohio within the existing I-71/I-75/US 50 interchange area. The existing Brent Spence Bridge will be rehabilitated to carry local C-D roadway traffic consisting of two lanes southbound and



three lanes northbound. Western and Winchell avenues will be improved to carry local traffic.

### **7.2.1 Alternative B Evaluation**

Alternative B is unique from the other conceptual alternatives because it follows a new alignment across the Ohio River and through the Queensgate area of Cincinnati. For I-71/I-75, a new bridge will be constructed approximately 900 feet west of the existing Brent Spence Bridge for I-71/I-75 traffic only. The alignment will pass through the Queensgate area and re-connect with the existing I-75 alignment near the Freeman Avenue Interchange. The new bridge across the Ohio River will have a middle span length of approximately 1,650 feet with end spans of approximately 650 feet in length. The approach structures to the new bridge would consist of approximately 13,000 feet of additional bridge structure as compared to the other alternatives.

Future (2035) traffic projections indicate similar levels of future congestion and delay on mainlines of the conceptual alternatives. When reviewing freeway segments and ramp junctions, Alternative B operates comparable to Alternatives C, D, and G as each of these alternatives generally provide the same number of lanes in each direction. Constructability and construction phasing issues are also similar among the alternatives although concerns have been expressed about risk and uncertainty with Alternative B. On February 12, 2009, a constructability workshop was held where participants concluded that Alternative B posed significant construction difficulties. These issues include accessibility and logistics for constructing the I-71 connector ramps to the new bridge alignment, relocation of transmission lines, slope stability on the south side of the Ohio River, and the greater possibility of encountering hazardous materials, buried objects, differing site conditions, and any other unknowns.

Environmental impacts expected for Alternative B are comparable to the other conceptual alternatives' impacts. Alternative B would impact three wetland areas, 11 woodlots, one threatened and endangered species potential habitat area, and four historic and five Section 4(f) resources. Alternative B would be located adjacent to the historic boundary of Longworth Hall and within 37 feet of the west end of the building. All other conceptual alternatives would have a direct impact to the eastern portion of this structure.

Alternative B requires the acquisition of 72.2 acres of additional land for right of way. This is more than 2.5 times the amount of land needed for any of the other conceptual alternatives. The community impacts of Alternative B include disruption of the West Covington neighborhood and loss of businesses in Queensgate. Alternative B would impact community cohesion in the Queensgate area by placing a new alignment through the neighborhood. Alternative B would displace 43 residential units and 34 businesses, which would affect approximately 1,900 employees. It would have 74 partial property takes. These would cause direct loss of property tax revenues to cities. KYTC and ODOT conducted a survey to determine whether these displaced businesses would remain in the area. In Kentucky, one business stated they would relocate out of the state while two businesses indicated they would close. In Ohio, the majority of businesses that responded to the survey indicated that they would not relocate outside of Cincinnati if impacted. The largest employer in the Queensgate area, United Parcel Service employing 919 people, indicated that they would relocate their operation outside of Cincinnati if displaced by the project.

As part of the public involvement process, both cities of Covington and Cincinnati have documented their opposition to Alternative B based on impacts to community services, loss of property values and taxes, and displacements of residences and businesses. The City of Covington specifically opposes the potential for impacts in West Covington as noted in a letter dated October 8, 2008, while the City of Cincinnati opposes the loss of businesses in the Queensgate area and loss of potential redevelopment opportunities. Further, the City of Cincinnati prepared a report entitled *Queensgate Area Issues, Considerations and Recommendations for Implementation of the Brent Spence Bridge Project* (September 2008), which describes the potential impacts that Alternative B would have on the Queensgate area. Within the Queensgate area, Alternative B would not use existing land uses in a way that is compatible with land use plans and would pass through areas where there are plans for redevelopment. Alternative B would result in the loss of future jobs and tax base in Queensgate due to impacts on redevelopment anticipated as a result of implementing the *Queensgate South Redevelopment Plan*. The fully executed plan is projected to generate 500 to 750 new jobs in the area.

Alternative B would directly impact three Section 4(f) resources: Goebel Park, the residence at 632 Western Avenue in Covington, and the Lewisburg Historic District. Coordination with park officials has been initiated and the impacts to Goebel Park could be mitigated, which would result in a Section 4(f) *de minimis* finding. Alternative B would encroach upon the Lewisburg Historic District along its eastern border and impact 2.4 acres of the historic district. It would displace eight residences adjacent to the west side of I-71/I-75, one of which is a non-contributing property to the historic district. Alternative B would displace the residence at 632 Western Avenue. Individual Section 4(f) evaluations would be prepared for the Lewisburg Historic District and the residence at 632 Western Avenue. Alternative B could have noise and visual impacts on two other Section 4(f) resources, the residences at 521 Western Avenue and 881 Highway Avenue in Covington. It is anticipated that Section 4(f) *de minimis* findings would be prepared for these two resources.

Alternative B impacts a total of 58 individual utilities, the greatest number of utility impacts of the conceptual alternatives. This is the only alternative that would not displace Duke Energy's West End Substation, which is located just west of the existing Brent Spence Bridge. However, it does require the relocation of major transmission lines and towers prior to construction of the bridge. This relocation would add two years to the construction period, which would add approximately \$240 million in inflation to the estimated \$2.86 billion project cost. Over this two year period, the level of service for the interstate system would continue to worsen.

Alternative B has the highest potential of the conceptual build alternatives to impact hazardous material sites because of its location through the Queensgate area. This area of Cincinnati has a history of industrial land use. Alternative B would impact approximately 50 percent more sites with hazardous material concerns than Alternatives C, D, E, and G due to their location within the existing highway right of way.

Alternative B would cost an estimated \$2.86 billion, which is at least \$150 million more than any of the other conceptual alternatives. The estimated cost for Kentucky is \$1.75 billion and the estimated cost for Ohio is \$1.11 billion. The estimated costs for

Alternative B are higher than conceptual Alternatives C, D, E, and G due to right of way acquisition and utility relocation.

Based on the adverse impacts to communities, residences, businesses, hazardous material sites, utilities and property acquisition associated with Alternative B, as well as the overall complexity, constructability risk, and cost, it is recommended that Alternative B be eliminated from further consideration.

### **7.3 Alternative C**

Alternative C is a variation of the former Alternative 3, I-71/I-75/US 50 Interchange Sub-Alternative 1, Hybrid of Collector-Distributor Roads Sub-Alternative 1 and Arterial Improvements Sub-Alternative 2 from the *Planning Study Report*. Alternative C south of KY 12<sup>th</sup> Street has six lanes northbound and six lanes southbound. A local C-D roadway is provided from KY 12<sup>th</sup> Street to the Ohio River. A new double deck bridge will be built just west of the existing Brent Spence Bridge for I-75 (two lanes in each direction), two lanes for southbound I-71 and two lanes for southbound local traffic. The existing Brent Spence Bridge will be rehabilitated to carry two lanes for northbound I-71 and three lanes for northbound local traffic. Alternative C reconfigures I-75 through the I-71/I-75/US 50 Interchange and eliminates all access to and from I-75 from KY 12<sup>th</sup> Street to just south of Ezzard Charles Drive in the northbound direction. Between Ezzard Charles Drive and the Western Hills Viaduct, northbound I-75 will have five lanes, southbound I-75 will have two lanes, and the local southbound C-D roadway will have four lanes, for a total of 11 travel lanes. Western and Winchell avenues will be improved to carry local traffic.

Alternatives C and D were developed based on the former Alternative 3 with very slight difference between them. The differences permitted the opportunity to evaluate how slight changes in horizontal and vertical configurations affected the flow of traffic with respect to level of service. The major difference between Alternatives C and D is the location and configuration of the C-D roadways in Ohio.

#### **7.3.1 Alternative C Evaluation**

The alignment of Alternative C provides a new bridge just west of the existing Brent Spence Bridge similar to Alternatives D, E, and G. Alternative C provides interstate access to both Covington and Cincinnati. Alternatives C and D provide a separation of local and regional traffic in both downtown areas through the use of C-D roadways.

Access into Covington from the interstate will be provided by the local C-D roadway at KY 12<sup>th</sup> Street for northbound traffic and at KY 9<sup>th</sup> Street for southbound traffic. Access to the interstate system from Covington will be provided at Pike Street for northbound traffic and at KY 12<sup>th</sup> Street for southbound traffic.

Access to downtown Cincinnati will be made through a series of C-D roadways that would require a decision point outside of the downtown area. In the northbound direction just north of the existing Brent Spence Bridge, the C-D roadway lane configuration is combined on a single structure between the OH 2<sup>nd</sup> Street diverge and the OH 5<sup>th</sup> Street diverge. Utilizing a single structure in this area simplifies the vertical geometric design, reduces costs, and would be easier to construct as compared to Alternative D, which utilizes three structures in this area. A negative aspect to combining the lane configuration onto a single structure is that it would introduce a

weave movement north of OH 5<sup>th</sup> Street from traffic coming from I-71 southbound traveling towards the Western Hills Viaduct. Upon analyzing the weave movement, no degradation of level of service was noted.

In the southbound direction, the Alternative C C-D roadway lane configuration is located west of I-75 north of Ezzard Charles Drive, similar to Alternative D. Upon passing under Ezzard Charles Drive, the southbound C-D roadway using a bridge crosses over I-75 which allows it to be located adjacent to the northbound C-D roadway. The intent was to isolate I-75 from the C-D roadways. Several design issues became apparent as a result. Crossing over I-75 created vertical geometry complications with steep grades, as underground utilities prevented I-75 from being lowered. Traffic entering from Western Avenue could no longer access I-71 northbound or US 50 eastbound. The ramp to OH 5<sup>th</sup> Street had to be eliminated due to limited horizontal separation between the two C-D roadways, which is needed to allow the OH 5<sup>th</sup> Street ramp to pass under US 50 and then cross over the northbound C-D roadway. The southbound C-D roadway remains on the west side in Alternative D in this area.

Future (2035) traffic projections indicate similar levels of future congestion and delay on the mainline as compared to Alternatives B, D, and G. Alternative C provides for more efficient traffic flow over the No Build Alternative when reviewing operations at basic freeway segments and ramp junctions. It does not provide the region with the most efficient traffic flow on its own. Portions of this alternative combined with another alternative may provide better traffic flow on the interstate and provide better connections to local roads. Constructability and construction phasing issues are also similar among the alternatives.

Alternative C requires approximately 22.2 acres of additional right of way. This is the second least amount of land impacted by the conceptual alternatives. Alternative C would displace 16 residential units and 35 businesses. Approximately 300 employees would be affected by this alternative. Alternative C, as with Alternatives D, E, and G, would impact Longworth Hall which includes 21 businesses. Alternatives C, D, E, and G have similar environmental impacts because they are all located within the existing transportation corridor. Alternative C would impact three wetland areas, 10 woodlots and one potential threatened and endangered species habitat area, four community resources, three historic resources, and five Section 4(f) properties.

Alternative C would be compatible with existing land use plans and would not have a negative impact on community cohesion. Alternative C would be constructed within the existing interstate corridor and not bisect neighborhoods in Kentucky or Ohio. Alternative C would support the Queensgate redevelopment plans and help Cincinnati facilitate its economic renewal goals.

Since the alignment of Alternative C would be located just west of the existing Brent Spence Bridge, it would impact a portion of the Duke Energy West End substation and require the relocation of 52 individual utility facilities.

Alternative C would directly impact four Section 4(f) resources. These include Goebel Park, the Lewisburg Historic District, Longworth Hall, and the Queensgate playground and ballfields. Alternative C could have noise and visual impacts on one Section 4(f) resource, the Harriet Beecher Stowe Elementary School (Fox 19 Television Station). It

is anticipated that a Section 4(f) *de minimis* finding would be prepared for this resource. Coordination with park officials has been initiated and the impacts to Goebel Park and the Queensgate playground and ballfields could be mitigated, which would result in Section 4(f) *de minimis* findings.

Alternative C would encroach upon the Lewisburg Historic District along its eastern border and directly impact 0.83 acres of the historic district. It would displace 10 residences adjacent to the west side of I-71/I-75, one of which is a non-contributing property to the historic district. Alternative C would directly impact 0.25 acres of Longworth Hall resource including the building and historic boundary. The eastern end of the building would be demolished. It is expected that individual Section 4(f) evaluations would be prepared for the Lewisburg Historic District and Longworth Hall due to the adverse effects of Alternative C.

Alternative C would cost an estimated \$2.28 billion, which is one of the least expensive alignments of the conceptual alternatives due to lower construction costs, less right of way, and lower costs for utility relocation. The estimated cost for Kentucky is \$1.41 billion and the estimated cost for Ohio is \$0.87 billion.

Based on the estimated cost, design features described above and the local access features, is it recommended that the northbound portion of Alternative C advance for further consideration, while the southbound portions of this alternative be eliminated from further consideration. It is recommended that the northbound portion of Alternative C be combined with the southbound portion of Alternative D to create a hybrid alternative for further evaluation.

## **7.4 Alternative D**

Alternative D is a variation of the former Alternative 3, I-71/I-75/US 50 Interchange Sub-Alternative 3, Hybrid of Collector-Distributor Roads Sub-Alternative 1 and Arterial Improvements Sub-Alternative 2 from the *Planning Study Report*. Alternative D south of KY 12<sup>th</sup> Street has six lanes northbound and six lanes southbound. A local C-D roadway will provide access into Covington between KY 12<sup>th</sup> Street and the Ohio River. A new double deck bridge will be built just west of the existing Brent Spence Bridge I-75 (two lanes in each direction), two lanes for southbound I-71, and two lanes for southbound local traffic. The existing Brent Spence Bridge will be rehabilitated to carry two lanes for northbound I-71 and three lanes for northbound local traffic. Alternative D reconfigures I-75 through the I-71/I-75/US 50 Interchange and eliminates all access to and from I-75 from KY 12<sup>th</sup> Street to just south of Ezzard Charles Drive in the northbound direction. In Ohio, between Ezzard Charles Drive and the Western Hills Viaduct there will be a total of 11 travel lanes for I-75 and local southbound traffic. Western and Winchell avenues will be improved to carry local traffic.

As previously noted, Alternatives C and D were developed based on the former Alternative 3 with very slight difference between them. The major difference between Alternatives C and D is the location and configuration of the C-D roadways in Ohio.

### **7.4.1 Alternative D Evaluation**

The alignment of Alternative D provides a new bridge alignment just west of the existing Brent Spence Bridge similar to Alternatives C, E, and G. Alternative D provides

interstate access to both Covington and Cincinnati. Like Alternative C, Alternative D provides a separation of local and regional traffic through the use of a C-D roadway.

Alternative D would keep one direct exit to Covington in place per the north and south bound directions, south of the current KY 5<sup>th</sup> Street exit. Access into Covington from the interstate will be provided by the local C-D roadway at KY 12<sup>th</sup> Street for northbound traffic and at KY 9<sup>th</sup> Street for southbound traffic. Access to the interstate system from Covington will be provided at KY 9<sup>th</sup> Street for northbound traffic and at KY 12<sup>th</sup> Street for southbound traffic.

Access to downtown Cincinnati will be made through a series of C-D roadways that would require a decision point outside of the downtown area. In the northbound direction, the C-D roadway lane configuration was split among three structures between the OH 2<sup>nd</sup> Street diverge and the OH 5<sup>th</sup> Street diverge to simplify the horizontal configuration to reduce the number of weave movements. Utilizing multiple structures, complicated the vertical geometric design, increased the cost, and is more complicated to construct. This design would not provide a better level of service compared to Alternative C. The vertical alignment of this alternative would require OH 3<sup>rd</sup> Street to be lowered approximately eight feet, west of Central Avenue due to the northbound C-D roadway lane configuration being split among three structures. This lowering would require complex and expensive retaining walls and the relocation of underground utilities.

In the southbound direction, the C-D roadway remains west of I-75. Traffic entering from Western Avenue will have access to I-71 northbound and US 50 eastbound, by using a weave condition. The ramp access to OH 5<sup>th</sup> Street will remain.

Future (2035) traffic projections indicate similar levels of future congestion and delay on the mainline as compared to Alternatives B, C, and G. Alternative D provides for more efficient traffic flow over the No Build Alternative when reviewing operations at basic freeway segments and ramp junctions. It does not provide the region with the most efficient traffic flow on its own. Various parts of this alternative combined with parts of another alternative may provide better traffic operations on the interstate and provide better connections to local roads. Constructability and construction phasing issues are also similar among the alternatives.

Environmental and community impacts resulting from Alternative D are the lowest of the conceptual alternatives. Alternative D would require approximately 19.7 acres of new right of way and would displace 16 residential units and 34 businesses. Alternative D, as with Alternatives C, E, and G would impact Longworth Hall which includes 21 businesses. Alternative D requires the fewest number of residence and business employee relocations. Alternative D would impact three wetland areas, 10 woodlots, one potential threatened and endangered species habitat area, four community resources, two historic properties, one historic district, and five Section 4(f) properties.

Alternative D would be compatible with existing land use plans and would not have a negative impact on community cohesion. Alternative D would be constructed within the existing interstate corridor and not bisect neighborhoods in Kentucky or Ohio. Alternative D would support the Queensgate redevelopment plans and help Cincinnati facilitate its economic renewal goals.

Since the alignment of Alternative D would be located just west of the existing Brent Spence Bridge, it would impact a portion of the Duke Energy West End substation and require the relocation of 52 individual utility facilities.

Alternative D would directly impact four Section 4(f) resources Goebel Park, the Lewisburg Historic District, Longworth Hall, and the Queensgate playground and ballfields. It could have visual and noise impacts on one Section 4(f) resource, the Harriet Beecher Stowe Elementary School (Fox 19 Television Station). It is anticipated that a Section 4(f) *de minimis* finding would be prepared for this resource. Coordination with park officials has been initiated and the impacts to Goebel Park and the Queensgate playground and ballfields could be mitigated, which would result in Section 4(f) *de minimis* findings.

Alternative D would encroach upon the Lewisburg Historic District along its eastern border and impact 0.88 acres of the historic district. It would displace 10 residences adjacent to the west side of I-71/I-75, one of which is a non-contributing property to the historic district. Alternative D would impact 0.25 acres of Longworth Hall resource including the building and historic boundary. The eastern end of the building would be demolished. It is expected that individual Section 4(f) evaluations would be prepared for the Lewisburg Historic District and Longworth Hall due to the adverse effects of Alternative D.

Alternative D would cost an estimated \$2.28 billion, which is one of the least expensive alignments of the conceptual alternatives. The estimated cost for Kentucky is \$1.41 billion and the estimated cost for Ohio is \$0.87 billion. Alternative D and Alternative C are the least expensive of the five conceptual alternatives due to lower construction costs, less right of way, and lower costs for utility relocation.

Based on the estimated cost, design features described above and the local access features, it is recommended that the southbound portion of Alternative D advance for further consideration, while the northbound portion of this alternative be eliminated from further consideration. It is recommended that the southbound portion of Alternative D be combined with the northbound portion of Alternative C to create a hybrid alternative for further evaluation.

## **7.5 Alternative E**

Alternative E is a variation of the former Alternative 3, I-71/I-75/US 50 Interchange Sub-Alternative 3, Hybrid of Collector-Distributor Roads Sub-Alternative 1 and Arterial Improvements Sub-Alternative 2 from the *Planning Study Report*. Alternative E south of KY 12<sup>th</sup> Street has six lanes northbound and six lanes southbound. Alternative E provides two access points into Covington for both northbound and southbound traffic. A local C-D roadway will be provided from KY 12<sup>th</sup> Street to the Ohio River. A new double deck bridge will be built just west of the existing Brent Spence Bridge to carry northbound and southbound I-71 and I-75 traffic. On the upper deck, I-71 southbound will have three lanes and I-71 northbound will have two lanes. On the lower deck, I-75 will have three northbound and three southbound lanes. The existing Brent Spence Bridge will be rehabilitated to carry northbound and southbound local traffic with two lanes in each direction as this number of lanes provides an acceptable level of service. In Ohio, Alternative E reconfigures I-75 through the I-71/I-75/US 50 Interchange and

eliminates some of the existing access points along I-75. The existing direct connections between I-75 to westbound US 50 and from eastbound US 50 will be maintained in Alternative E. Between Ezzard Charles Drive and Western Hills Viaduct, southbound I-75 will have six lanes, northbound I-75 will have five lanes, and there will be one auxiliary lane to the Western Hills Viaduct. Western and Winchell avenues will be improved to carry local traffic.

### **7.5.1 Alternative E Evaluation**

The alignment of Alternative E is similar to Alternatives C, D, and G in that it provides a new bridge alignment just west of the existing Brent Spence Bridge. Alternative E provides two direct access points to Covington in both the northbound and southbound directions. In the northbound direction, access will be provided by the local C-D roadway at KY 12<sup>th</sup> Street and KY 5<sup>th</sup> Street. In the southbound direction, access will be provided by the local C-D roadway at KY 5<sup>th</sup> Street, and off of I-71 and I-75 at KY 9<sup>th</sup> Street. Access to the interstate system from Covington will be provided by local city streets. In the northbound direction, access to I-75 will be provided at KY 9<sup>th</sup> Street, access to I-71 will be provided at KY 5<sup>th</sup> Street. Access to I-75 northbound will also be provided at KY 4<sup>th</sup> and 5<sup>th</sup> Streets through the local C-D roadway across the lower deck of the existing Brent Spence Bridge. In the southbound direction, access to I-71/I-75 will be provided at KY 5<sup>th</sup> Street and KY 12<sup>th</sup> Street.

All access to downtown Cincinnati from I-75 will be provided by a C-D roadway that would require a decision point outside of the downtown area, KY 12<sup>th</sup> Street for northbound traffic and just south of Ezzard Charles Drive for southbound traffic. Access to I-75 northbound will be provided at OH 4<sup>th</sup> and 6<sup>th</sup> streets through the local C-D roadway and at OH 9<sup>th</sup> Street through Winchell Avenue. Southbound I-75 access will be provided at Western Avenue, OH 8<sup>th</sup> Street, and OH 4<sup>th</sup> Street through the local C-D roadway across the upper deck of the existing Brent Spence Bridge.

Future (2035) traffic projections indicate similar levels of future congestion and delay on the mainline as compared to Alternatives B, C, and G except for the I-75 mainline when I-75 consists of three lanes in each direction. When reviewing the level of service at basic freeway segments and ramp junctions, Alternative E operates better overall than all of the other alternatives. Notable improvements for I-75 level of service (LOS) were: LOS F to D in the northbound PM peak hour, LOS E to D in the southbound AM peak hour, and LOS D to C in the southbound PM peak hour. The improved traffic flow will aid in the reduction of traffic crashes, reduce delay and travel times throughout the region. Constructability and construction phasing issues are also similar among the alternatives.

When compared to Alternatives C, E, and G, Alternative E is expected to have similar environmental impacts. Alternative E would impact three wetland areas, 10 woodlots and one potential threatened and endangered species habitat area. Alternative E would impact three community resources, two historic resources, one historic district, and four Section 4(f) properties. This is slightly fewer impacts than other conceptual alternatives. Alternative E would displace 19 residential units and 39 businesses, which is the fewest number of people displaced among alternatives. Alternative E, as with Alternatives C, D, and G, would impact Longworth Hall which includes 21 businesses. In addition, the 19 residential units estimated to be displaced to build Alternative E is expected to result in the fewest number of people displaced.



Alternative E would be compatible with existing land use plans and would not have a negative impact on community cohesion. Alternative E would be constructed within the existing interstate corridor and not bisect neighborhoods in Kentucky or Ohio. Alternative E would support the Queensgate redevelopment plans and help Cincinnati facilitate its economic renewal goals.

Since the alignment of Alternative E would be located just west of the existing Brent Spence Bridge, it would impact a portion of the Duke Energy West End substation and require the relocation of 52 individual utility facilities.

Alternative E would directly impact three Section 4(f) resources Goebel Park, the Lewisburg Historic District, and Longworth Hall. It could also have noise and visual impacts on one Section 4(f) resource, the Harriet Beecher Stowe Elementary School (Fox 19 Television Station). It is anticipated that a Section 4(f) *de minimis* finding would be prepared for this resource. Coordination with park officials has been initiated and the impacts to Goebel Park could be mitigated, which would result in a Section 4(f) *de minimis* finding.

Alternative E would encroach upon the Lewisburg Historic District along its eastern border and impact 0.98 acres of the historic district. It would displace 11 residences adjacent to the west side of I-71/I-75, one of which is a non-contributing property to the historic district. Alternative E would impact 0.54 acres of Longworth Hall resource including the building and historic boundary. The eastern end of the building would be demolished. It is expected that individual Section 4(f) evaluations would be prepared for the Lewisburg Historic District and Longworth Hall due to the adverse effects of Alternative E.

Alternative E would cost an estimated \$2.58 billion, which is in the mid-range of the costs for the conceptual alternatives. The estimated cost for Kentucky is \$1.65 billion and the estimated cost for Ohio is \$0.93 billion. Only Alternatives C and D have lower estimated costs.

Alternative E is recommended and supported by the City of Covington. Based on the access provided by this alternative and the minimized amount of community impacts in comparison to other alternatives, it is recommended that Alternative E be advanced for further study as a feasible alternative. Based on the improved LOS, it is recommended to increase the number of lanes for I-75 to three lanes in each direction due to the level of service improvements noted above.

## **7.6 Alternative G**

Alternative G is a variation of the former Alternative 4, I-71/I-75/US 50 Interchange Sub-Alternative 3, Hybrid of Collector-Distributor Roads Sub-Alternative 1 and Arterial Improvements Sub-Alternative 2 from the *Planning Study Report*. Alternative G south of KY 12<sup>th</sup> Street has six lanes northbound and six lanes southbound. In Alternative G, there are two access points into Covington for both northbound and southbound traffic through a C-D roadway. Local city streets will provide access to the interstate system from Covington. A new double deck bridge will be built just west of the existing Brent Spence Bridge to carry northbound and southbound I-75 (two lanes in each direction), two lanes for southbound I-71, and two lanes for southbound local traffic. The existing

Brent Spence Bridge will be rehabilitated to carry two lanes for northbound I-71 and three lanes for local traffic. Alternative G reconfigures I-75 through the I-71/I-75/US 50 Interchange and eliminates all access to and from I-75 between KY 12<sup>th</sup> Street to just north of Ezzard Charles Drive in the northbound direction. I-75 would be elevated from the Ohio River to just south of Linn Street for northbound and southbound traffic. In Ohio, the northbound C-D roadway will carry local traffic from the existing Brent Spence Bridge, provide access to US 50 and city streets, and reconnect to I-75 just north of Ezzard Charles Drive. In Ohio, the southbound C-D roadway will provide a new access point to the north end of the Clay Wade Bailey Bridge. Western and Winchell avenues will be improved to carry local traffic.

### **7.6.1 Alternative G Evaluation**

The alignment of Alternative G is similar to Alternatives C, D, and E in that it provides a new bridge alignment just west of the existing Brent Spence Bridge. Alternative G provides two direct access points to Covington in both northbound and southbound directions. In the northbound direction, access will be provided by the local C-D roadway at KY 12<sup>th</sup> Street and KY 5<sup>th</sup> Street. In the southbound direction, access will be provided by the local C-D roadway at KY 5<sup>th</sup> Street and KY 9<sup>th</sup> Street. Access to the interstate system from Covington will be provided by local city streets. In the northbound direction, access to I-71 will be provided at KY 9<sup>th</sup> Street, and access to I-71/I-75 will be provided by the local C-D roadway at KY 4<sup>th</sup> Street. In the southbound direction, access to I-71/I-75 will be provided at KY 12<sup>th</sup> Street.

Alternative G eliminates all access to and from I-75 between KY 12<sup>th</sup> Street to just north of Ezzard Charles Drive in the northbound direction. Between KY 9<sup>th</sup> Street and Western Hills Viaduct there will be no access to southbound I-75. In Ohio, I-75 will be elevated from the Ohio River to just south of Linn Street. Existing connections to I-71, US 50, and downtown Cincinnati will be maintained. Direct local access from Cincinnati to I-75 will be provided by an exit at OH 9<sup>th</sup> Street. All other existing interstate access points in downtown Cincinnati will be made by way of C-D roadways.

Future (2035) traffic projections indicate similar levels of future congestion and delay on the mainline as compared to Alternatives B, C, and D. When reviewing the level of service at the basic freeway segments and ramp junctions, Alternative G operates better overall than the other alternatives, with the exception of Alternative E. Improvements to safety and traffic flow are some of the benefits of this alternative. Constructability and construction phasing issues are also similar among the alternatives.

Alternative G requires approximately 28.2 acres of new right of way. Alternative G would displace 31 residential units and 41 businesses, which would affect approximately 1,300 employees. The United Parcel Service, which employs 919 persons, is one of the businesses that would be impacted by Alternative G. Alternative G, as with Alternatives C, D, and E, would impact Longworth Hall which includes 21 businesses. When compared to Alternatives C, D, and E, Alternative G has similar environmental impacts. Alternative G would impact three wetland areas and ten woodlots, one potential threatened and endangered species habitat area; four community resources, two historic properties, one historic district, and five Section 4(f) properties.

Overall, Alternative G supports local land use with the exception for the impact to UPS. Alternative G would be compatible with existing land use plans and would not have a

negative impact on community cohesion. Alternative G would be constructed mostly within the existing interstate corridor and not bisect neighborhoods in Kentucky or Ohio. Alternative G would support the existing Queensgate redevelopment plans and help Cincinnati facilitate its economic renewal goals.

Since the alignment of Alternative G would be located just west of the existing Brent Spence Bridge, it would impact a portion of the Duke Energy West End substation and require the relocation of 52 individual utility facilities.

Alternative G would directly impact four Section 4(f) resources Goebel Park, the Lewisburg Historic District, Longworth Hall, and the Queensgate playground and ballfields. It could also have noise and visual impacts on one Section 4(f) resource, the Harriet Beecher Stowe Elementary School (Fox 19 Television Station). It is anticipated that a Section 4(f) *de minimis* finding would be prepared for this resource. Coordination with park officials has been initiated and the impacts to Goebel Park and the Queensgate playground and ballfields could be mitigated, which would result in Section 4(f) *de minimis* findings.

Alternative G would encroach upon the Lewisburg Historic District along its eastern border and impact 2.9 acres of the historic district. It would displace 12 residences adjacent to the west side of I-71/I-75, two of which are non-contributing properties to the historic district. Alternatives G would impact 0.42 acres of Longworth Hall resource including the building and historic boundary. The eastern end of the building would be demolished. It is expected that individual Section 4(f) evaluations would be prepared for the Lewisburg Historic District and Longworth Hall due to the adverse effects of Alternative G.

Alternative G would cost an estimated \$2.70 billion, which is the second most expensive alignment of the five conceptual alternatives. Alternative B at \$2.86 billion is the most expensive of all the conceptual alternatives. The estimated cost for Kentucky is \$1.47 billion and the estimated cost for Ohio is \$1.23 billion. Alternative G has the highest overall cost of the alternatives which follow the existing I-71/I-75 corridor.

Alternative G is recommended to be eliminated from further consideration due to the high costs of this alternative and the higher property acquisition associated with it. Alternative G would result in 31 residential and 41 business displacements. The business displacements would affect over 1,300 employees.

## **7.7 Feasible Alternatives**

Based on the adverse impacts to communities, residences, businesses, hazardous material sites, utilities and property acquisition associated with Alternative B, as well as the overall complexity, constructability risk, and cost, it is recommended that Alternative B be eliminated from further consideration for the Brent Spence Replacement/ Rehabilitation Project.

It is recommended that a combination of Alternatives C and D be developed for further study in Step 6 as a feasible alternative. As discussed, Alternatives C and D are very similar in overall design. Based on the comparative analysis with respect to horizontal and vertical alignments, impacts, and the flow of traffic of Alternatives C and D, it was

determined that a hybrid alternative of the northbound portion of Alternative C and the southbound portion of Alternative D be advanced for further consideration.

It is recommended that Alternative E be developed for further study in Step 6 as a feasible alternative. This recommendation is based on the access provided by Alternative E to Covington and Cincinnati and the minimal amount of community impacts in comparison to the other alternatives. It is recommended to increase the number of lanes for I-75 to three lanes in each direction to support the improved level of service this alternative will provide.

It is recommended that Alternative G be eliminated from further consideration due to the high costs, and residential and business displacements associated with this alternative. However, the following beneficial design features of Alternative G will be carried forward for further analysis and incorporated into the feasible alternatives:

- access to north end of Clay Wade Bailey Bridge from I-75 southbound using a C-D roadway and US 50 eastbound;
- two access points into Covington;
- access from a northbound C-D roadway from KY to I-71 northbound in Ohio; and
- access ramp just north of Ezzard Charles Drive for Freeman Ave and local traffic to I-75 northbound.

#### **7.7.1 Recommended Feasible Alternatives**

The comparative analysis led to the recommendation of carrying forward two feasible alternatives. The two feasible alternatives consist of Alternative E and a combination of Alternatives C and D. Based on the analyses completed and feedback as part of community input, it is also recommended that certain design elements (as listed above) of Alternative G be incorporated into the two feasible alternatives in Step 6 of the Ohio Department of Transportation's Project Development Process. Additionally, the two feasible alternatives will be designed to provide three lanes in each direction on I-75.

Conceptual Alternatives Evaluation Matrix						
Impacts	No Build	Alternative B (Former Alternative 2)	Alternative C (Former Alternative 3)	Alternative D (Former Alternative 3)	Alternative E (Former Alternative 3)	Alternative G (Former Alternative 4 Hybrid)
<b>Alternative Description</b>	The No Build Alternative consists of minor, short-term safety and maintenance improvements to the Brent Spence Bridge and I-75 corridor, which would maintain continuing operations. All within existing right of way.	Six lanes each direction between Kyles Lane to KY 12 <sup>th</sup> Street; Local C-D roadway from KY 12 <sup>th</sup> Street to Ohio River; New bridge (4 lanes in each direction) through Queensgate 900 feet west of existing for I-71/I-75 traffic; Rehab existing bridge for local traffic (2 lanes SB and 3 lanes NB); Realign US 50; Improvements to Western and Winchell Avenues	Six lanes in each direction between Kyles Lane and KY 12 <sup>th</sup> Street; local C-D roadway from KY 12 <sup>th</sup> Street to Ohio River; New double deck bridge just west of existing bridge for I-75 (2 lanes NB and SB), 2 lanes SB I-71, two lanes SB local traffic; Rehab existing bridge for NB I-71 (2 lanes), NB local traffic (3 lanes); Reconfigure I-75 through I-71/I-75/US 50 Interchange; From KY 12 <sup>th</sup> Street to Ezzard Charles Drive NB I-75 5 lanes, SB I-75 2 lanes, and local SB C-D roadway 4 lanes; Improvements to Western and Winchell Avenues	Six lanes in each direction between Kyles Lane and KY 12 <sup>th</sup> Street; Local C-D roadway between KY 12 <sup>th</sup> Street and the Ohio River; New double deck bridge just west of the existing bridge I-75 (2 lanes NB and SB), two lanes SB I-71, and two lanes SB local traffic; Rehab existing bridge for NB I-71 (2 lanes) and three lanes for NB local traffic (3 lanes); Reconfigure I-75 through the I-71/I-75/US 50 Interchange; 11 lanes for I-75 and SB local traffic between Ezzard Charles Drive and the Western Hills Viaduct; Improvements to Western and Winchell Avenues	Six lanes in each direction between Kyles Lane and KY 12 <sup>th</sup> Street; Two access points into Covington for both NB and SB traffic; New double-deck bridge just west of the existing Bridge for I-71/I-75 traffic (2 lanes in each direction); Reconfigure I-75 through the I-71/I-75/US 50 Interchange; Between Ezzard Charles Drive and Western Hills Viaduct, SB I-75 6 lanes, NB I-75 5 lanes, and one auxiliary lane to the Western Hills Viaduct; Improvements to Western and Winchell Avenues	Six lanes in each direction between Kyles Lane and KY 12 <sup>th</sup> Street; 2 access points to Covington for NB and SB traffic through a C-D roadway; New double deck bridge just west of the existing bridge for I-75 (2 lanes in each direction), 2 lanes for SB I-71 and 2 lanes for SB local traffic; Rehab existing bridge for NB I-71 (2 lanes) and local traffic (3 lanes); Reconfigure I-75 through the I-71/I-75/US 50 Interchange; I-75 elevated from Ohio River to Linn Street; NB C-D roadway will carry local traffic to Ezzard Charles Drive; Improvements to Western and Winchell Avenues
<b>Purpose and Need Elements</b>						
Improve traffic flow and level of service in 2035	Does not improve traffic flow and level of service <ul style="list-style-type: none"> <li>• Congestion will continue to worsen</li> <li>• I-71 majority of segments (43 of 50) LOS E or F</li> <li>• I-75 majority of segments (43 of 50) LOS E or F</li> </ul>	Improves traffic and level of service over the No Build <ul style="list-style-type: none"> <li>• I-71 majority LOS E or F segments</li> <li>• I-75 NB three LOS F segments</li> <li>• I-75 SB two LOS F segments</li> <li>• Improves congested sections</li> </ul>	Improves traffic and level of service over the No Build <ul style="list-style-type: none"> <li>• I-75 NB three LOS F segments</li> <li>• I-75 SB two LOS F segments</li> <li>• I-71 majority LOS E or F segments</li> <li>• Reduces congested segments</li> </ul>	Improves traffic and level of service over the No Build <ul style="list-style-type: none"> <li>• I-75 NB three LOS F segments</li> <li>• I-75 SB two LOS F segments</li> <li>• I-71 majority LOS E or F segments</li> <li>• Reduces congested sections</li> </ul>	Improves traffic and level of service over the No Build <ul style="list-style-type: none"> <li>• I-75 majority segments are LOS D or better</li> <li>• I-75 NB and SB two segments LOS F</li> <li>• I-71 majority segments of LOS E or F</li> <li>• Additional lanes for I-75 to reduce congestion through Covington and Cincinnati;</li> </ul>	Improves traffic and level of service over the No Build <ul style="list-style-type: none"> <li>• I-75 NB three LOS F segments</li> <li>• I-75 SB two LOS F segments</li> <li>• I-71 majority segments LOS E or F</li> </ul>
Improve safety	Will not improve safety	Improves safety <ul style="list-style-type: none"> <li>• Provides proper shoulder widths</li> <li>• Improves geometries</li> <li>• Separates local and interstate traffic to help reduce accident rates</li> </ul>	Improves safety <ul style="list-style-type: none"> <li>• Provides proper shoulder widths</li> <li>• Lower design speed for local C-D roadway help reduce accident rates</li> </ul>	Improves safety <ul style="list-style-type: none"> <li>• Provides proper shoulder widths</li> <li>• Improves geometry on I-75 to help reduce accident rates</li> </ul>	Improves safety <ul style="list-style-type: none"> <li>• Reduced congested sections,</li> <li>• Provides proper shoulder widths to help reduce accident rates</li> </ul>	Improves safety <ul style="list-style-type: none"> <li>• Reduced congested sections</li> <li>• Proper shoulder widths</li> <li>• Improved geometries help reduce accident rates</li> </ul>
Correct geometric deficiencies	Will not correct geometric deficiencies	Corrects geometric deficiencies with design exceptions <ul style="list-style-type: none"> <li>• I-71 remains geometrically deficient</li> </ul>	Corrects geometric deficiencies with design exceptions <ul style="list-style-type: none"> <li>• I-71 remains geometrically deficient</li> <li>• I-75, US 50 and local C-D roadway has several geometrically deficient locations</li> </ul>	Corrects geometric deficiencies with design exceptions <ul style="list-style-type: none"> <li>• I-71 remains geometrically deficient</li> <li>• US 50 geometrically deficient in several locations</li> </ul>	Corrects geometric deficiencies with design exceptions <ul style="list-style-type: none"> <li>• I-71 remains geometrically deficient</li> <li>• Local C-D roadway geometrically deficient in several locations</li> </ul>	Corrects geometric deficiencies with design exceptions <ul style="list-style-type: none"> <li>• I-71 remains geometrically deficient</li> </ul>

Conceptual Alternatives Evaluation Matrix						
Impacts	No Build	Alternative B (Former Alternative 2)	Alternative C (Former Alternative 3)	Alternative D (Former Alternative 3)	Alternative E (Former Alternative 3)	Alternative G (Former Alternative 4 Hybrid)
<b>Alternative Description</b>	The No Build Alternative consists of minor, short-term safety and maintenance improvements to the Brent Spence Bridge and I-75 corridor, which would maintain continuing operations. All within existing right of way.	Six lanes each direction between Kyles Lane to KY 12 <sup>th</sup> Street; Local C-D roadway from KY 12 <sup>th</sup> Street to Ohio River; New bridge (4 lanes in each direction) through Queensgate 900 feet west of existing for I-71/I-75 traffic; Rehab existing bridge for local traffic (2 lanes SB and 3 lanes NB); Realign US 50; Improvements to Western and Winchell Avenues	Six lanes in each direction between Kyles Lane and KY 12 <sup>th</sup> Street; local C-D roadway from KY 12 <sup>th</sup> Street to Ohio River; New double deck bridge just west of existing bridge for I-75 (2 lanes NB and SB), 2 lanes SB I-71, two lanes SB local traffic; Rehab existing bridge for NB I-71 (2 lanes), NB local traffic (3 lanes); Reconfigure I-75 through I-71/I-75/US 50 Interchange; From KY 12 <sup>th</sup> Street to Ezzard Charles Drive NB I-75 5 lanes, SB I-75 2 lanes, and local SB C-D roadway 4 lanes; Improvements to Western and Winchell Avenues	Six lanes in each direction between Kyles Lane and KY 12 <sup>th</sup> Street; Local C-D roadway between KY 12 <sup>th</sup> Street and the Ohio River; New double deck bridge just west of the existing bridge I-75 (2 lanes NB and SB), two lanes SB I-71, and two lanes SB local traffic; Rehab existing bridge for NB I-71 (2 lanes) and three lanes for NB local traffic (3 lanes); Reconfigure I-75 through the I-71/I-75/US 50 Interchange; 11 lanes for I-75 and SB local traffic between Ezzard Charles Drive and the Western Hills Viaduct; Improvements to Western and Winchell Avenues	Six lanes in each direction between Kyles Lane and KY 12 <sup>th</sup> Street; Two access points into Covington for both NB and SB traffic; New double-deck bridge just west of the existing Bridge for I-71/I-75 traffic (2 lanes in each direction); Reconfigure I-75 through the I-71/I-75/US 50 Interchange; Between Ezzard Charles Drive and Western Hills Viaduct, SB I-75 6 lanes, NB I-75 5 lanes, and one auxiliary lane to the Western Hills Viaduct; Improvements to Western and Winchell Avenues	Six lanes in each direction between Kyles Lane and KY 12 <sup>th</sup> Street; 2 access points to Covington for NB and SB traffic through a C-D roadway; New double deck bridge just west of the existing bridge for I-75 (2 lanes in each direction), 2 lanes for SB I-71 and 2 lanes for SB local traffic; Rehab existing bridge for NB I-71 (2 lanes) and local traffic (3 lanes); Reconfigure I-75 through the I-71/I-75/US 50 Interchange; I-75 elevated from Ohio River to Linn Street; NB C-D roadway will carry local traffic to Ezzard Charles Drive; Improvements to Western and Winchell Avenues
Maintain and improve connections to local, regional, and national transportation corridors	Maintains but does not improve existing connections	Changes and improves connections <ul style="list-style-type: none"> <li>Local traffic separated from regional traffic on I-75 in Cincinnati and Covington</li> <li>No direct connections to I-75 and I-71 through Queensgate area</li> </ul>	Does not maintain all existing connections <ul style="list-style-type: none"> <li>Removes local connections to I-75 by using a C-D system from KY 12<sup>th</sup> Street to just south of Ezzard Charles Drive</li> </ul>	Does not maintain all existing connections <ul style="list-style-type: none"> <li>Removes local connections to I-75 by using a C-D system from KY 12<sup>th</sup> Street to just south of Ezzard Charles Drive</li> </ul>	Maintains and improves connections <ul style="list-style-type: none"> <li>Maintains access to I-75 and I-71 in Covington</li> <li>uses a C-D system for local connections in Covington and Cincinnati</li> <li>US 50 maintains direct access to interstate</li> </ul>	Removes some local connections <ul style="list-style-type: none"> <li>Access provided to I-75 by using a C-D system in Cincinnati and Covington</li> </ul>
<b>Engineering</b>						
Maintain and improve connections: Provides local access to/from the interstate	Provides local access to/from the interstate as it currently exists	Provides access to interstate by way of local C-D road <ul style="list-style-type: none"> <li>I-75 access between KY 12<sup>th</sup> Street and Ezzard Charles Drive</li> </ul> Provides direct access to interstate <ul style="list-style-type: none"> <li>1 direct access point to I-71 NB in KY at Pike Street</li> </ul>	Provides access to interstate by way of local C-D road <ul style="list-style-type: none"> <li>I-75 access between KY 12<sup>th</sup> Street and Ezzard Charles Drive</li> </ul> Provides direct access to interstate <ul style="list-style-type: none"> <li>1 direct access point to I-71 NB in KY at Pike Street</li> </ul>	Provides indirect access to interstate by way of local C-D road <ul style="list-style-type: none"> <li>I-75 access between KY 12<sup>th</sup> Street and Ezzard Charles Drive</li> </ul> Provides direct access to interstate <ul style="list-style-type: none"> <li>1 direct access point to I-71 NB at KY 9<sup>th</sup> Street</li> </ul>	Provides indirect access to interstate by way of local C-D road <ul style="list-style-type: none"> <li>I-75 access KY 12<sup>th</sup> Street and Ezzard Charles Drive</li> </ul> Provides direct access to interstate <ul style="list-style-type: none"> <li>1 direct access point to I-71 NB in KY</li> <li>1 direct access point to I-75 NB in KY</li> <li>Direct access to I-71/I-75 SB in KY at 5<sup>th</sup> Street</li> </ul>	Provides indirect access to interstate by way of local C-D road <ul style="list-style-type: none"> <li>I-75 access KY 12<sup>th</sup> Street and Ezzard Charles Drive</li> </ul> Provides direct access to interstate <ul style="list-style-type: none"> <li>1 direct access point to I-71 NB at KY 9<sup>th</sup> Street</li> </ul>
Maintain and improve connections: Provides direct access to Covington from I-75	Provides direct local access to/from the I-75 as it currently exists	Provides indirect access to Covington from I-75 by a C-D road <ul style="list-style-type: none"> <li>NB access at KY 12<sup>th</sup> Street</li> <li>SB access at KY 9<sup>th</sup> Street</li> </ul>	Provides indirect access to Covington from I-75 by a C-D road <ul style="list-style-type: none"> <li>NB access at KY 12<sup>th</sup> Street</li> <li>SB access at KY 9<sup>th</sup> Street</li> </ul>	Provides indirect access to Covington from I-75 by a C-D road <ul style="list-style-type: none"> <li>NB access at KY 12<sup>th</sup> Street</li> <li>SB access at KY 9<sup>th</sup> Street</li> </ul>	Provides direct access to Covington <ul style="list-style-type: none"> <li>SB I-75 and SB I-71 access at KY 9<sup>th</sup> NB traffic</li> </ul> Provides indirect access to Covington by C-D road <ul style="list-style-type: none"> <li>Access at KY 12<sup>th</sup> Street</li> </ul>	Provides indirect access to Covington by C-D road <ul style="list-style-type: none"> <li>NB access at KY 12<sup>th</sup> and KY 5<sup>th</sup> streets</li> <li>SB access at KY 5<sup>th</sup> and KY 9<sup>th</sup> streets</li> </ul>

Conceptual Alternatives Evaluation Matrix						
Impacts	No Build	Alternative B (Former Alternative 2)	Alternative C (Former Alternative 3)	Alternative D (Former Alternative 3)	Alternative E (Former Alternative 3)	Alternative G (Former Alternative 4 Hybrid)
<b>Alternative Description</b>	The No Build Alternative consists of minor, short-term safety and maintenance improvements to the Brent Spence Bridge and I-75 corridor, which would maintain continuing operations. All within existing right of way.	Six lanes each direction between Kyles Lane to KY 12 <sup>th</sup> Street; Local C-D roadway from KY 12 <sup>th</sup> Street to Ohio River; New bridge (4 lanes in each direction) through Queensgate 900 feet west of existing for I-71/I-75 traffic; Rehab existing bridge for local traffic (2 lanes SB and 3 lanes NB); Realign US 50; Improvements to Western and Winchell Avenues	Six lanes in each direction between Kyles Lane and KY 12 <sup>th</sup> Street; local C-D roadway from KY 12 <sup>th</sup> Street to Ohio River; New double deck bridge just west of existing bridge for I-75 (2 lanes NB and SB), 2 lanes SB I-71, two lanes SB local traffic; Rehab existing bridge for NB I-71 (2 lanes), NB local traffic (3 lanes); Reconfigure I-75 through I-71/I-75/US 50 Interchange; From KY 12 <sup>th</sup> Street to Ezzard Charles Drive NB I-75 5 lanes, SB I-75 2 lanes, and local SB C-D roadway 4 lanes; Improvements to Western and Winchell Avenues	Six lanes in each direction between Kyles Lane and KY 12 <sup>th</sup> Street; Local C-D roadway between KY 12 <sup>th</sup> Street and the Ohio River; New double deck bridge just west of the existing bridge I-75 (2 lanes NB and SB), two lanes SB I-71, and two lanes SB local traffic; Rehab existing bridge for NB I-71 (2 lanes) and three lanes for NB local traffic (3 lanes); Reconfigure I-75 through the I-71/I-75/US 50 Interchange; 11 lanes for I-75 and SB local traffic between Ezzard Charles Drive and the Western Hills Viaduct; Improvements to Western and Winchell Avenues	Six lanes in each direction between Kyles Lane and KY 12 <sup>th</sup> Street; Two access points into Covington for both NB and SB traffic; New double-deck bridge just west of the existing Bridge for I-71/I-75 traffic (2 lanes in each direction); Reconfigure I-75 through the I-71/I-75/US 50 Interchange; Between Ezzard Charles Drive and Western Hills Viaduct, SB I-75 6 lanes, NB I-75 5 lanes, and one auxiliary lane to the Western Hills Viaduct; Improvements to Western and Winchell Avenues	Six lanes in each direction between Kyles Lane and KY 12 <sup>th</sup> Street; 2 access points to Covington for NB and SB traffic through a C-D roadway; New double deck bridge just west of the existing bridge for I-75 (2 lanes in each direction), 2 lanes for SB I-71 and 2 lanes for SB local traffic; Rehab existing bridge for NB I-71 (2 lanes) and local traffic (3 lanes); Reconfigure I-75 through the I-71/I-75/US 50 Interchange; I-75 elevated from Ohio River to Linn Street; NB C-D roadway will carry local traffic to Ezzard Charles Drive; Improvements to Western and Winchell Avenues
Maintain and improve connections: Maintains existing access points to I-75 in Cincinnati	Maintains local access to/from I-75 as it currently exists	Maintains local access to/from the interstate as it currently exists	Eliminates direct access to/from I-75; Access provided by C-D road <ul style="list-style-type: none"> <li>I-75 NB access eliminated between KY 12<sup>th</sup> Street to just south of Ezzard Charles Drive</li> <li>I-75 SB access eliminated between KY 9<sup>th</sup> Street and the Western Hills Viaduct</li> <li>Access provided by C-D road</li> </ul>	Alters existing access to I-75 <ul style="list-style-type: none"> <li>Existing I-75 NB and SB access eliminated or reconfigured between KY 12<sup>th</sup> Street to just north of Ezzard Charles</li> <li>Existing direct access to/from I-75 will remain but reconfigured at US 50</li> </ul>	Eliminates direct access to/from I-75 <ul style="list-style-type: none"> <li>I-75 NB access eliminated between KY 12<sup>th</sup> Street to just north of Ezzard Charles Drive</li> <li>I-75 SB access between KY 9<sup>th</sup> Street and the Western Hills Viaduct</li> </ul>	
Separates local and regional traffic	Does not separate Interstate system as it currently exists	Separates local and regional traffic <ul style="list-style-type: none"> <li>A new bridge for I-71/I-75 traffic will be constructed through Queensgate</li> <li>Existing Brent Spence Bridge will be rehabilitated to carry local NB and SB traffic.</li> </ul>	Separates local and regional traffic <ul style="list-style-type: none"> <li>A new bridge just west of the existing Brent Spence Bridge will be constructed to carry I-75 NB and SB, I-71 SB, and local SB traffic</li> <li>Existing Brent Spence Bridge will be rehabilitated to carry I-71 NB and local NB traffic.</li> </ul>	Separates local and regional traffic <ul style="list-style-type: none"> <li>A new bridge just west of the existing Brent Spence Bridge will be constructed to carry I-75 and I-71 NB and SB traffic</li> <li>The existing Brent Spence Bridge will be rehabilitated to carry local NB and SB traffic.</li> </ul>	Separates local and regional traffic <ul style="list-style-type: none"> <li>A new bridge just west of the existing Brent Spence Bridge will be constructed to carry I-75 NB and SB, I-71 SB, and local SB traffic</li> <li>The existing Brent Spence Bridge will be rehabilitated to carry I-71 NB and local NB traffic.</li> </ul>	
<b>Environmental Resources</b>						
Wetlands – (number of wetland areas and total acreage impacted)	None	3 Wetland areas totaling 0.59 acres impacted in KY	3 Wetland areas totaling 0.59 acres impacted in KY	3 Wetland areas totaling 0.59 acres impacted in KY	3 Wetland areas totaling 0.59 acres impacted in KY	3 Wetland areas totaling 0.59 acres impacted in KY
Ohio River – (number of new bridge crossings and new piers in the river)	None	<ul style="list-style-type: none"> <li>New bridge located 900 feet west of existing Brent Spence Bridge</li> <li>Two piers located on north and south river banks, less than 10% of the piers will be in the river</li> </ul>	<ul style="list-style-type: none"> <li>New bridge located 120 feet west of existing Brent Spence Bridge</li> <li>Two new piers located in the river within 35 feet of the existing bridge piers</li> </ul>	<ul style="list-style-type: none"> <li>New bridge located 120 feet west of existing Brent Spence Bridge</li> <li>Two new piers located in the river within 35 feet of the existing bridge piers</li> </ul>	<ul style="list-style-type: none"> <li>New bridge located 120 feet west of existing Brent Spence Bridge;</li> <li>Two new piers located in the river within 35 feet of the existing bridge piers</li> </ul>	<ul style="list-style-type: none"> <li>New bridge located 120 feet west of existing Brent Spence Bridge;</li> <li>Two new piers located in the river within 35 feet of the existing bridge piers</li> </ul>
Streams – (total linear feet impacted)	None	<ul style="list-style-type: none"> <li>207 Feet from 2 intermittent streams</li> <li>245 Feet from 1 ephemeral stream</li> </ul>	<ul style="list-style-type: none"> <li>207 Feet from 2 intermittent streams</li> <li>245 Feet from 1 ephemeral stream</li> </ul>	<ul style="list-style-type: none"> <li>207 Feet from 2 intermittent streams</li> <li>245 Feet from 1 ephemeral stream</li> </ul>	<ul style="list-style-type: none"> <li>207 Feet from 2 intermittent streams</li> <li>245 Feet from 1 ephemeral stream</li> </ul>	<ul style="list-style-type: none"> <li>207 Feet from 2 intermittent streams</li> <li>245 Feet from 1 ephemeral stream</li> </ul>

Conceptual Alternatives Evaluation Matrix						
Impacts	No Build	Alternative B (Former Alternative 2)	Alternative C (Former Alternative 3)	Alternative D (Former Alternative 3)	Alternative E (Former Alternative 3)	Alternative G (Former Alternative 4 Hybrid)
<b>Alternative Description</b>	The No Build Alternative consists of minor, short-term safety and maintenance improvements to the Brent Spence Bridge and I-75 corridor, which would maintain continuing operations. All within existing right of way.	Six lanes each direction between Kyles Lane to KY 12 <sup>th</sup> Street; Local C-D roadway from KY 12 <sup>th</sup> Street to Ohio River; New bridge (4 lanes in each direction) through Queensgate 900 feet west of existing for I-71/I-75 traffic; Rehab existing bridge for local traffic (2 lanes SB and 3 lanes NB); Realign US 50; Improvements to Western and Winchell Avenues	Six lanes in each direction between Kyles Lane and KY 12 <sup>th</sup> Street; local C-D roadway from KY 12 <sup>th</sup> Street to Ohio River; New double deck bridge just west of existing bridge for I-75 (2 lanes NB and SB), 2 lanes SB I-71, two lanes SB local traffic; Rehab existing bridge for NB I-71 (2 lanes), NB local traffic (3 lanes); Reconfigure I-75 through I-71/I-75/US 50 Interchange; From KY 12 <sup>th</sup> Street to Ezzard Charles Drive NB I-75 5 lanes, SB I-75 2 lanes, and local SB C-D roadway 4 lanes; Improvements to Western and Winchell Avenues	Six lanes in each direction between Kyles Lane and KY 12 <sup>th</sup> Street; Local C-D roadway between KY 12 <sup>th</sup> Street and the Ohio River; New double deck bridge just west of the existing bridge I-75 (2 lanes NB and SB), two lanes SB I-71, and two lanes SB local traffic; Rehab existing bridge for NB I-71 (2 lanes) and three lanes for NB local traffic (3 lanes); Reconfigure I-75 through the I-71/I-75/US 50 Interchange; 11 lanes for I-75 and SB local traffic between Ezzard Charles Drive and the Western Hills Viaduct; Improvements to Western and Winchell Avenues	Six lanes in each direction between Kyles Lane and KY 12 <sup>th</sup> Street; Two access points into Covington for both NB and SB traffic; New double-deck bridge just west of the existing Bridge for I-71/I-75 traffic (2 lanes in each direction); Reconfigure I-75 through the I-71/I-75/US 50 Interchange; Between Ezzard Charles Drive and Western Hills Viaduct, SB I-75 6 lanes, NB I-75 5 lanes, and one auxiliary lane to the Western Hills Viaduct; Improvements to Western and Winchell Avenues	Six lanes in each direction between Kyles Lane and KY 12 <sup>th</sup> Street; 2 access points to Covington for NB and SB traffic through a C-D roadway; New double deck bridge just west of the existing bridge for I-75 (2 lanes in each direction), 2 lanes for SB I-71 and 2 lanes for SB local traffic; Rehab existing bridge for NB I-71 (2 lanes) and local traffic (3 lanes); Reconfigure I-75 through the I-71/I-75/US 50 Interchange; I-75 elevated from Ohio River to Linn Street; NB C-D roadway will carry local traffic to Ezzard Charles Drive; Improvements to Western and Winchell Avenues
Threatened and Endangered Species	None	<ul style="list-style-type: none"> <li>8 Woodlots with potential Indiana bat habitat</li> <li>3 Woodlots with marginal Indiana bat habitat (additional woodlot on west side of Western Ave in KY)</li> <li>1 Area with potential running buffalo clover habitat</li> </ul>	<ul style="list-style-type: none"> <li>8 Woodlots with potential Indiana bat habitat</li> <li>2 Woodlots with marginal Indiana bat habitat</li> <li>1 Area with potential running buffalo clover habitat</li> </ul>	<ul style="list-style-type: none"> <li>8 Woodlots with potential Indiana bat habitat</li> <li>2 Woodlots with marginal Indiana bat habitat</li> <li>1 Area with potential running buffalo clover habitat</li> </ul>	<ul style="list-style-type: none"> <li>8 Woodlots with potential Indiana bat habitat</li> <li>2 Woodlots with marginal Indiana bat habitat</li> <li>1 Area with potential running buffalo clover habitat</li> </ul>	<ul style="list-style-type: none"> <li>8 Woodlots with potential Indiana bat habitat</li> <li>2 Woodlots with marginal Indiana bat habitat</li> <li>1 Area with potential running buffalo clover habitat</li> </ul>
Floodplains	None	17.8 Acres of floodplain impacted	4.2 Acres of floodplain impacted	4.0 Acres of floodplain impacted	6.0 Acres of floodplain impacted	5.2 Acres of floodplain impacted
<b>Cultural Resources</b>						
Individual properties eligible for listing or listed in the National Register of Historic Places (NRHP)	None	3 Properties: 3 Potentially eligible properties: <ul style="list-style-type: none"> <li>Residence at 632 Western Avenue direct impact</li> <li>Residence at 521 Western Avenue potential visual and noise impacts</li> <li>Residence at 881 Highway Avenue potential visual and noise impacts</li> </ul>	2 Properties: 1 Potentially eligible property: <ul style="list-style-type: none"> <li>Harriet Beecher Stowe Elementary School potential visual and noise impacts</li> </ul> 1 NRHP Listed: <ul style="list-style-type: none"> <li>Longworth Hall direct impact (0.25 acres and eastern portion of building)</li> </ul>	2 Properties: 1 Potentially eligible property: <ul style="list-style-type: none"> <li>Harriet Beecher Stowe Elementary School potential visual and noise impacts</li> </ul> 1 NRHP Listed: <ul style="list-style-type: none"> <li>Longworth Hall direct impact (0.25 acres and eastern portion of building)</li> </ul>	2 Properties: 1 Potentially eligible property: <ul style="list-style-type: none"> <li>Harriet Beecher Stowe Elementary School potential visual and noise impacts</li> </ul> 1 NRHP Listed: <ul style="list-style-type: none"> <li>Longworth Hall direct impact (0.54 acres and eastern portion of building)</li> </ul>	2 Properties: 1 Potentially eligible property: <ul style="list-style-type: none"> <li>Harriet Beecher Stowe Elementary School potential visual and noise impacts</li> </ul> 1 NRHP Listed: <ul style="list-style-type: none"> <li>Longworth Hall direct impact (0.42 acres and eastern portion of building)</li> </ul>
Historic Districts (HD) directly impacted	None	2.4 Acres impacted of NRHP Listed Lewisburg HD <ul style="list-style-type: none"> <li>Direct impacts to 8 residences (1 non-contributing; 7 contributing)</li> </ul>	0.83 Acres impacted of NRHP Listed Lewisburg HD <ul style="list-style-type: none"> <li>Direct impacts to 10 residences (1 non-contributing; 9 contributing)</li> </ul>	0.88 Acres impacted of NRHP Listed Lewisburg HD <ul style="list-style-type: none"> <li>Direct impacts to 10 residences (1 non-contributing; 9 contributing)</li> </ul>	0.98 Acres impacted of NRHP Listed Lewisburg HD <ul style="list-style-type: none"> <li>Direct impacts to 11 residences (1 non-contributing; 10 contributing)</li> </ul>	2.9 Acres impacted of NRHP Listed Lewisburg HD <ul style="list-style-type: none"> <li>Direct impacts to 12 residences (2 non-contributing; 10 contributing)</li> </ul>



Conceptual Alternatives Evaluation Matrix						
Impacts	No Build	Alternative B (Former Alternative 2)	Alternative C (Former Alternative 3)	Alternative D (Former Alternative 3)	Alternative E (Former Alternative 3)	Alternative G (Former Alternative 4 Hybrid)
<b>Alternative Description</b>	The No Build Alternative consists of minor, short-term safety and maintenance improvements to the Brent Spence Bridge and I-75 corridor, which would maintain continuing operations. All within existing right of way.	Six lanes each direction between Kyles Lane to KY 12 <sup>th</sup> Street; Local C-D roadway from KY 12 <sup>th</sup> Street to Ohio River; New bridge (4 lanes in each direction) through Queensgate 900 feet west of existing for I-71/I-75 traffic; Rehab existing bridge for local traffic (2 lanes SB and 3 lanes NB); Realign US 50; Improvements to Western and Winchell Avenues	Six lanes in each direction between Kyles Lane and KY 12 <sup>th</sup> Street; local C-D roadway from KY 12 <sup>th</sup> Street to Ohio River; New double deck bridge just west of existing bridge for I-75 (2 lanes NB and SB), 2 lanes SB I-71, two lanes SB local traffic; Rehab existing bridge for NB I-71 (2 lanes), NB local traffic (3 lanes); Reconfigure I-75 through I-71/I-75/US 50 Interchange; From KY 12 <sup>th</sup> Street to Ezzard Charles Drive NB I-75 5 lanes, SB I-75 2 lanes, and local SB C-D roadway 4 lanes; Improvements to Western and Winchell Avenues	Six lanes in each direction between Kyles Lane and KY 12 <sup>th</sup> Street; Local C-D roadway between KY 12 <sup>th</sup> Street and the Ohio River; New double deck bridge just west of the existing bridge I-75 (2 lanes NB and SB), two lanes SB I-71, and two lanes SB local traffic; Rehab existing bridge for NB I-71 (2 lanes) and three lanes for NB local traffic (3 lanes); Reconfigure I-75 through the I-71/I-75/US 50 Interchange; 11 lanes for I-75 and SB local traffic between Ezzard Charles Drive and the Western Hills Viaduct; Improvements to Western and Winchell Avenues	Six lanes in each direction between Kyles Lane and KY 12 <sup>th</sup> Street; Two access points into Covington for both NB and SB traffic; New double-deck bridge just west of the existing Bridge for I-71/I-75 traffic (2 lanes in each direction); Reconfigure I-75 through the I-71/I-75/US 50 Interchange; Between Ezzard Charles Drive and Western Hills Viaduct, SB I-75 6 lanes, NB I-75 5 lanes, and one auxiliary lane to the Western Hills Viaduct; Improvements to Western and Winchell Avenues	Six lanes in each direction between Kyles Lane and KY 12 <sup>th</sup> Street; 2 access points to Covington for NB and SB traffic through a C-D roadway; New double deck bridge just west of the existing bridge for I-75 (2 lanes in each direction), 2 lanes for SB I-71 and 2 lanes for SB local traffic; Rehab existing bridge for NB I-71 (2 lanes) and local traffic (3 lanes); Reconfigure I-75 through the I-71/I-75/US 50 Interchange; I-75 elevated from Ohio River to Linn Street; NB C-D roadway will carry local traffic to Ezzard Charles Drive; Improvements to Western and Winchell Avenues
<b>Community Resources</b>						
Facilities and Services (property or structure impacted)	None	3 Properties or structures: <ul style="list-style-type: none"> <li>• Notre Dame Academy School (tennis courts)</li> <li>• Goebel Park (walking path, ball courts, parking lot)</li> <li>• Central Church of the Nazarene (KY) (parking lot)</li> </ul>	4 Properties or structures: <ul style="list-style-type: none"> <li>• Notre Dame Academy School (tennis courts)</li> <li>• Goebel Park (walking path, ball courts, parking lot)</li> <li>• Queensgate Playground (strip take of ballfields)</li> <li>• Central Church of the Nazarene (KY) (parking lot)</li> </ul>	4 Properties or structures: <ul style="list-style-type: none"> <li>• Notre Dame Academy School (tennis courts)</li> <li>• Goebel Park (walking path, ball courts, parking lot)</li> <li>• Queensgate Playground (strip take of ballfields)</li> <li>• Central Church of the Nazarene (KY) (parking lot)</li> </ul>	3 Properties or structures: <ul style="list-style-type: none"> <li>• Notre Dame Academy School (tennis courts)</li> <li>• Goebel Park (strip take of property)</li> <li>• Central Church of the Nazarene (KY) (parking lot)</li> </ul>	4 Properties or structures: <ul style="list-style-type: none"> <li>• Notre Dame Academy School (tennis courts)</li> <li>• Goebel Park (ball courts)</li> <li>• Queensgate Playground (strip take of ballfields)</li> <li>• Central Church of the Nazarene (KY) (parking lot)</li> </ul>
Community Cohesion	None	<ul style="list-style-type: none"> <li>• Loss of homes and local businesses on Crescent Avenue in West Covington neighborhood</li> <li>• Loss of 8 homes in the Lewisburg neighborhood and Historic District adjacent to I-71/I-75</li> <li>• Traverses the Queensgate business district</li> <li>• Residents displaced near Western Hills Viaduct</li> </ul>	<ul style="list-style-type: none"> <li>• Loss of 10 homes in the Lewisburg neighborhood and Historic District adjacent to I-71/I-75</li> <li>• Residents displaced near Western Hills Viaduct</li> </ul>	<ul style="list-style-type: none"> <li>• Loss of 10 homes in the Lewisburg neighborhood and Historic District adjacent to I-71/I-75</li> <li>• Residents displaced near Western Hills Viaduct</li> </ul>	<ul style="list-style-type: none"> <li>• Loss of 8 homes in the Lewisburg neighborhood and Historic District adjacent to I-71/I-75</li> <li>• Residents displaced near Western Hills Viaduct</li> </ul>	<ul style="list-style-type: none"> <li>• Loss of homes and local businesses on Crescent Avenue in West Covington neighborhood</li> <li>• Loss of 12 homes in the Lewisburg neighborhood and Historic District adjacent to I-71/I-75</li> <li>• Residents displaced near Western Hills Viaduct</li> </ul>
Environmental Justice – (impacts neighborhoods and Census tracts with high percentage of low income and minority populations)	None	<ul style="list-style-type: none"> <li>• No minority population impact in KY</li> <li>• Medium impact to low-income populations (residences displaced in Lewisburg) in KY</li> <li>• Impact to facilities in Goebel Park</li> <li>• Medium impact to low-income population in Ohio</li> <li>• No disproportionate impacts</li> </ul>	<ul style="list-style-type: none"> <li>• No minority population impact in KY</li> <li>• Medium impact to low-income populations (residences displaced in Lewisburg) in KY</li> <li>• Impact to facilities in Goebel Park</li> <li>• Strip taken of land in Queensgate ballfields</li> <li>• Medium impact to low-income population in Ohio</li> <li>• No disproportionate impacts</li> </ul>	<ul style="list-style-type: none"> <li>• No minority population impact in KY</li> <li>• Medium impact to low-income populations (residences displaced in Lewisburg) in KY</li> <li>• Strip taken of land in Queensgate ballfields</li> <li>• Medium impact to low-income population in Ohio</li> <li>• No disproportionate impacts</li> </ul>	<ul style="list-style-type: none"> <li>• No minority population impact in KY</li> <li>• Medium impact to low-income populations (residences displaced in Lewisburg) in KY</li> <li>• Impact to land in Goebel Park</li> <li>• Medium impact to low-income population in Ohio</li> <li>• No disproportionate impacts</li> </ul>	<ul style="list-style-type: none"> <li>• No minority population impact in KY</li> <li>• Medium impact to low-income populations (residences displaced in Lewisburg) in KY</li> <li>• Strip taken of land in Queensgate ballfields</li> <li>• Medium impact to low-income population in Ohio</li> <li>• No disproportionate impacts</li> </ul>

Conceptual Alternatives Evaluation Matrix						
Impacts	No Build	Alternative B (Former Alternative 2)	Alternative C (Former Alternative 3)	Alternative D (Former Alternative 3)	Alternative E (Former Alternative 3)	Alternative G (Former Alternative 4 Hybrid)
<b>Alternative Description</b>	The No Build Alternative consists of minor, short-term safety and maintenance improvements to the Brent Spence Bridge and I-75 corridor, which would maintain continuing operations. All within existing right of way.	Six lanes each direction between Kyles Lane to KY 12 <sup>th</sup> Street; Local C-D roadway from KY 12 <sup>th</sup> Street to Ohio River; New bridge (4 lanes in each direction) through Queensgate 900 feet west of existing for I-71/I-75 traffic; Rehab existing bridge for local traffic (2 lanes SB and 3 lanes NB); Realign US 50; Improvements to Western and Winchell Avenues	Six lanes in each direction between Kyles Lane and KY 12 <sup>th</sup> Street; local C-D roadway from KY 12 <sup>th</sup> Street to Ohio River; New double deck bridge just west of existing bridge for I-75 (2 lanes NB and SB), 2 lanes SB I-71, two lanes SB local traffic; Rehab existing bridge for NB I-71 (2 lanes), NB local traffic (3 lanes); Reconfigure I-75 through I-71/I-75/US 50 Interchange; From KY 12 <sup>th</sup> Street to Ezzard Charles Drive NB I-75 5 lanes, SB I-75 2 lanes, and local SB C-D roadway 4 lanes; Improvements to Western and Winchell Avenues	Six lanes in each direction between Kyles Lane and KY 12 <sup>th</sup> Street; Local C-D roadway between KY 12 <sup>th</sup> Street and the Ohio River; New double deck bridge just west of the existing bridge I-75 (2 lanes NB and SB), two lanes SB I-71, and two lanes SB local traffic; Rehab existing bridge for NB I-71 (2 lanes) and three lanes for NB local traffic (3 lanes); Reconfigure I-75 through the I-71/I-75/US 50 Interchange; 11 lanes for I-75 and SB local traffic between Ezzard Charles Drive and the Western Hills Viaduct; Improvements to Western and Winchell Avenues	Six lanes in each direction between Kyles Lane and KY 12 <sup>th</sup> Street; Two access points into Covington for both NB and SB traffic; New double-deck bridge just west of the existing Bridge for I-71/I-75 traffic (2 lanes in each direction); Reconfigure I-75 through the I-71/I-75/US 50 Interchange; Between Ezzard Charles Drive and Western Hills Viaduct, SB I-75 6 lanes, NB I-75 5 lanes, and one auxiliary lane to the Western Hills Viaduct; Improvements to Western and Winchell Avenues	Six lanes in each direction between Kyles Lane and KY 12 <sup>th</sup> Street; 2 access points to Covington for NB and SB traffic through a C-D roadway; New double deck bridge just west of the existing bridge for I-75 (2 lanes in each direction), 2 lanes for SB I-71 and 2 lanes for SB local traffic; Rehab existing bridge for NB I-71 (2 lanes) and local traffic (3 lanes); Reconfigure I-75 through the I-71/I-75/US 50 Interchange; I-75 elevated from Ohio River to Linn Street; NB C-D roadway will carry local traffic to Ezzard Charles Drive; Improvements to Western and Winchell Avenues
<b>Section 4(f) and 6(f) Resources</b>						
Section 6(f) Parks – acres of properties impacted	None	1.86 Acres of Goebel Park impacted (walking path, ball courts, parking lot)	2.6 Acres of Goebel Park impacted (walking path, ball courts, parking lot)	1.94 Acres of Goebel Park impacted (walking path, ball courts, parking lot)	0.35 Acres of Goebel Park impacted (strip take of property)	0.78 Acres of Goebel Park impacted (ball courts)
Section 4(f) Resources – (number of properties directly and potentially indirectly impacted)	None	5 Resources impacted: <ul style="list-style-type: none"> <li>Goebel Park (1.86 acres)</li> <li>Lewisburg Historic District (2.4 acres; 8 residences - 1 non-contributing and 7 contributing)</li> <li>Residence at 632 Western Avenue direct impact</li> <li>Residence at 521 Western Avenue potential visual and noise impacts</li> <li>Residence at 881 Highway Avenue potential visual and noise impacts</li> </ul>	5 Resources impacted: <ul style="list-style-type: none"> <li>Goebel Park (2.6 acres)</li> <li>Lewisburg Historic District (0.83 acres; 10 residences: 1 non-contributing; 9 contributing)</li> <li>Longworth Hall (0.25 acres)</li> <li>Harriet Beecher Stowe Elementary School potential visual and noise impacts</li> <li>Queensgate Playground (0.31 acres)</li> </ul>	5 Resources impacted: <ul style="list-style-type: none"> <li>Goebel Park (1.94 acres)</li> <li>Lewisburg Historic District (0.88 acres; 10 residences - 1 non-contributing; 9 contributing)</li> <li>Longworth Hall (0.25 acres)</li> <li>Harriet Beecher Stowe Elementary School potential visual and noise impacts</li> <li>Queensgate Playground (0.45 acres)</li> </ul>	4 Resources impacted: <ul style="list-style-type: none"> <li>Goebel Park (0.35 acres)</li> <li>Lewisburg Historic District (0.98 acres; 11 residences - 1 non-contributing; 10 contributing)</li> <li>Longworth Hall (0.54 acres)</li> <li>Harriet Beecher Stowe Elementary School potential visual and noise impacts</li> </ul>	5 Resources impacted: <ul style="list-style-type: none"> <li>Goebel Park (0.78 acres)</li> <li>Lewisburg Historic District (2.9 acres; 12 residences - 2 non-contributing; 10 contributing)</li> <li>Longworth Hall (0.42 acres)</li> <li>Harriet Beecher Stowe Elementary School potential visual and noise impacts</li> <li>Queensgate Playground (0.29 acres)</li> </ul>

Conceptual Alternatives Evaluation Matrix						
Impacts	No Build	Alternative B (Former Alternative 2)	Alternative C (Former Alternative 3)	Alternative D (Former Alternative 3)	Alternative E (Former Alternative 3)	Alternative G (Former Alternative 4 Hybrid)
<b>Alternative Description</b>	The No Build Alternative consists of minor, short-term safety and maintenance improvements to the Brent Spence Bridge and I-75 corridor, which would maintain continuing operations. All within existing right of way.	Six lanes each direction between Kyles Lane to KY 12 <sup>th</sup> Street; Local C-D roadway from KY 12 <sup>th</sup> Street to Ohio River; New bridge (4 lanes in each direction) through Queensgate 900 feet west of existing for I-71/I-75 traffic; Rehab existing bridge for local traffic (2 lanes SB and 3 lanes NB); Realign US 50; Improvements to Western and Winchell Avenues	Six lanes in each direction between Kyles Lane and KY 12 <sup>th</sup> Street; local C-D roadway from KY 12 <sup>th</sup> Street to Ohio River; New double deck bridge just west of existing bridge for I-75 (2 lanes NB and SB), 2 lanes SB I-71, two lanes SB local traffic; Rehab existing bridge for NB I-71 (2 lanes), NB local traffic (3 lanes); Reconfigure I-75 through I-71/I-75/US 50 Interchange; From KY 12 <sup>th</sup> Street to Ezzard Charles Drive NB I-75 5 lanes, SB I-75 2 lanes, and local SB C-D roadway 4 lanes; Improvements to Western and Winchell Avenues	Six lanes in each direction between Kyles Lane and KY 12 <sup>th</sup> Street; Local C-D roadway between KY 12 <sup>th</sup> Street and the Ohio River; New double deck bridge just west of the existing bridge I-75 (2 lanes NB and SB), two lanes SB I-71, and two lanes SB local traffic; Rehab existing bridge for NB I-71 (2 lanes) and three lanes for NB local traffic (3 lanes); Reconfigure I-75 through the I-71/I-75/US 50 Interchange; 11 lanes for I-75 and SB local traffic between Ezzard Charles Drive and the Western Hills Viaduct; Improvements to Western and Winchell Avenues	Six lanes in each direction between Kyles Lane and KY 12 <sup>th</sup> Street; Two access points into Covington for both NB and SB traffic; New double-deck bridge just west of the existing Bridge for I-71/I-75 traffic (2 lanes in each direction); Reconfigure I-75 through the I-71/I-75/US 50 Interchange; Between Ezzard Charles Drive and Western Hills Viaduct, SB I-75 6 lanes, NB I-75 5 lanes, and one auxiliary lane to the Western Hills Viaduct; Improvements to Western and Winchell Avenues	Six lanes in each direction between Kyles Lane and KY 12 <sup>th</sup> Street; 2 access points to Covington for NB and SB traffic through a C-D roadway; New double deck bridge just west of the existing bridge for I-75 (2 lanes in each direction), 2 lanes for SB I-71 and 2 lanes for SB local traffic; Rehab existing bridge for NB I-71 (2 lanes) and local traffic (3 lanes); Reconfigure I-75 through the I-71/I-75/US 50 Interchange; I-75 elevated from Ohio River to Linn Street; NB C-D roadway will carry local traffic to Ezzard Charles Drive; Improvements to Western and Winchell Avenues
<b>Property Acquisition</b>						
Residential – (total estimated structures and residences displaced)	None	42 Structures: KY – 38 (65-260 residents displaced) • Majority of residences along Western and Crescent Avenues in KY OH – 5 (10-36 residents displaced) • OH residences near Western Hills Viaduct	16 Structures: KY – 11 (13-52 residents displaced) • Majority of residences along Crescent Avenue in KY OH – 5 (10-36 residents displaced) • OH residences near Western Hills Viaduct	16 Structures: KY – 11 (13-52 residents displaced) • Majority of residences along Crescent Avenue in KY OH – 5 (10-36 residents displaced) • OH residences near Western Hills Viaduct	19 Structures: KY – 13 (12-48 residents displaced) • Majority of residences along Crescent Avenue in KY OH – 6 (11-40 residents displaced) • OH residences near Western Hills Viaduct and Western Avenue	31 Structures: KY – 25 (28-112 residents displaced) • Majority of residences along Crescent Avenue in KY OH – 6 (11-40 residents displaced) • OH residences near Western Hills Viaduct
Business – (total estimated businesses and employees displaced)	None	34 Businesses displaced: KY – 8 (121-158 employees) • KY businesses mostly on KY 3 <sup>rd</sup> and 4 <sup>th</sup> streets and Crescent Avenue OH – 26 (1,791-1,831 employees) • Impacts United Parcel Service (OH) with approximately 900 employees and Butternut Bread with 200 employees • Majority of businesses are in Queensgate area	35 Businesses displaced: KY – 4 (90-115 employees) • KY businesses mostly on KY 3 <sup>rd</sup> and 4 <sup>th</sup> streets OH – 31(242-283 employees) • 21 Businesses within Longworth Hall (OH) with approximately 100 employees	34 Businesses displaced: KY – 4 (90-115 employees) • KY businesses mostly on KY 3 <sup>rd</sup> and 4 <sup>th</sup> streets OH – 30 (164-190 employees) • 21 Businesses within Longworth Hall (OH) with approximately 100 employees	39 Businesses displaced: KY – 4 (90-115 employees) • KY businesses mostly on KY 3 <sup>rd</sup> and 4 <sup>th</sup> streets OH – 35 (327-363 employees) • 21 Businesses within Longworth Hall (OH) with approximately 100 employees	41 Businesses displaced: KY – 7 (103-140 employees) • KY businesses mostly on KY 3 <sup>rd</sup> and 4 <sup>th</sup> streets and Crescent Avenue OH – 34 (1,215-1,251 employees) • Impacts United Parcel Service (OH) with approximately 900 employees • 21 Businesses within Longworth Hall (OH) with approximately 100 employees
Partial property acquisition – (number of parcels with partial takes)	None	88 (KY – 67; OH – 24)	61 (KY – 42; OH – 19)	66 (KY – 48; OH – 18)	55 (KY – 39; OH – 16)	79 (KY – 54; OH – 25)
Right of Way Impacts – (acres converted to right of way)	None	72.2 Acres converted	22.2 Acres converted	19.7 Acres converted	22.3 Acres converted	28.2 Acres converted

Conceptual Alternatives Evaluation Matrix						
Impacts	No Build	Alternative B (Former Alternative 2)	Alternative C (Former Alternative 3)	Alternative D (Former Alternative 3)	Alternative E (Former Alternative 3)	Alternative G (Former Alternative 4 Hybrid)
<b>Alternative Description</b>	The No Build Alternative consists of minor, short-term safety and maintenance improvements to the Brent Spence Bridge and I-75 corridor, which would maintain continuing operations. All within existing right of way.	Six lanes each direction between Kyles Lane to KY 12 <sup>th</sup> Street; Local C-D roadway from KY 12 <sup>th</sup> Street to Ohio River; New bridge (4 lanes in each direction) through Queensgate 900 feet west of existing for I-71/I-75 traffic; Rehab existing bridge for local traffic (2 lanes SB and 3 lanes NB); Realign US 50; Improvements to Western and Winchell Avenues	Six lanes in each direction between Kyles Lane and KY 12 <sup>th</sup> Street; local C-D roadway from KY 12 <sup>th</sup> Street to Ohio River; New double deck bridge just west of existing bridge for I-75 (2 lanes NB and SB), 2 lanes SB I-71, two lanes SB local traffic; Rehab existing bridge for NB I-71 (2 lanes), NB local traffic (3 lanes); Reconfigure I-75 through I-71/I-75/US 50 Interchange; From KY 12 <sup>th</sup> Street to Ezzard Charles Drive NB I-75 5 lanes, SB I-75 2 lanes, and local SB C-D roadway 4 lanes; Improvements to Western and Winchell Avenues	Six lanes in each direction between Kyles Lane and KY 12 <sup>th</sup> Street; Local C-D roadway between KY 12 <sup>th</sup> Street and the Ohio River; New double deck bridge just west of the existing bridge I-75 (2 lanes NB and SB), two lanes SB I-71, and two lanes SB local traffic; Rehab existing bridge for NB I-71 (2 lanes) and three lanes for NB local traffic (3 lanes); Reconfigure I-75 through the I-71/I-75/US 50 Interchange; 11 lanes for I-75 and SB local traffic between Ezzard Charles Drive and the Western Hills Viaduct; Improvements to Western and Winchell Avenues	Six lanes in each direction between Kyles Lane and KY 12 <sup>th</sup> Street; Two access points into Covington for both NB and SB traffic; New double-deck bridge just west of the existing Bridge for I-71/I-75 traffic (2 lanes in each direction); Reconfigure I-75 through the I-71/I-75/US 50 Interchange; Between Ezzard Charles Drive and Western Hills Viaduct, SB I-75 6 lanes, NB I-75 5 lanes, and one auxiliary lane to the Western Hills Viaduct; Improvements to Western and Winchell Avenues	Six lanes in each direction between Kyles Lane and KY 12 <sup>th</sup> Street; 2 access points to Covington for NB and SB traffic through a C-D roadway; New double deck bridge just west of the existing bridge for I-75 (2 lanes in each direction), 2 lanes for SB I-71 and 2 lanes for SB local traffic; Rehab existing bridge for NB I-71 (2 lanes) and local traffic (3 lanes); Reconfigure I-75 through the I-71/I-75/US 50 Interchange; I-75 elevated from Ohio River to Linn Street; NB C-D roadway will carry local traffic to Ezzard Charles Drive; Improvements to Western and Winchell Avenues
<b>Land Use</b>						
Residential – (total acres of residential uses)	None	4.94 Acres (KY – 4.80; OH – 0.14)	5.45 Acres (KY – 5.30; OH – 0.15)	5.17 Acres (KY – 5.01; OH – 0.16)	3.35 Acres (KY – 3.19; OH – 0.16)	4.04 Acres (KY – 3.77; OH – 0.27)
Commercial – (total acres of commercial uses)	None	6.82 Acres (KY – 1.52; OH – 5.30)	4.56 Acres (KY – 3.42; OH – 1.14)	4.06 Acres (KY – 3.13; OH – 0.93)	4.29 Acres (KY – 2.79; OH – 1.50)	5.04 Acres (KY – 3.75; OH – 1.29)
Industrial – (total acres of industrial uses)	None	18.56 Acres (KY – 5.61; OH – 12.95)	0.70 Acres (KY - 0; OH – 0.70)	0.48 Acres (KY - 0; OH – 0.48)	0.88 Acres (KY - 0; OH – 0.88)	2.01 Acres (KY - 0; OH – 1.65)
Other – (total acres of other land uses)	None	41.88 Acres (KY – 14.53; OH – 27.36)	11.59 Acres (KY – 5.06; OH – 6.53)	10.07 Acres (KY – 4.64; OH – 5.44)	13.18 Acres (KY – 4.35; OH – 8.83)	17.12 Acres (KY – 9.45; OH – 7.67)
Compatibility with existing community land use plans	Not compatible with economic development plans	Not compatible with plans <ul style="list-style-type: none"> <li>Goes through area of <i>Queensgate South Redevelopment Plan</i></li> <li>Impacts on goals of <i>GO Cincinnati</i> for Queensgate</li> <li>Changes land uses noted in Northern Kentucky comprehensive plans</li> </ul>	Compatible with plans <ul style="list-style-type: none"> <li>Supports redevelopment and economic plans in Queensgate and Cincinnati</li> <li>Keeps land uses conducive with Northern Kentucky comprehensive plans</li> </ul>	Compatible with plans <ul style="list-style-type: none"> <li>Supports redevelopment and economic plans in Queensgate and Cincinnati</li> <li>Keeps land uses conducive with Northern Kentucky comprehensive plans</li> </ul>	Compatible with plans <ul style="list-style-type: none"> <li>Supports redevelopment and economic plans in Queensgate and Cincinnati</li> <li>Keeps land uses conducive with Northern Kentucky comprehensive plans</li> </ul>	Compatible with some plans <ul style="list-style-type: none"> <li>Supports redevelopment and economic plans in Queensgate</li> <li>Changes some land use in Queensgate</li> <li>Keeps land uses conducive with Northern Kentucky comprehensive plans</li> </ul>

Conceptual Alternatives Evaluation Matrix						
Impacts	No Build	Alternative B (Former Alternative 2)	Alternative C (Former Alternative 3)	Alternative D (Former Alternative 3)	Alternative E (Former Alternative 3)	Alternative G (Former Alternative 4 Hybrid)
<b>Alternative Description</b>	The No Build Alternative consists of minor, short-term safety and maintenance improvements to the Brent Spence Bridge and I-75 corridor, which would maintain continuing operations. All within existing right of way.	Six lanes each direction between Kyles Lane to KY 12 <sup>th</sup> Street; Local C-D roadway from KY 12 <sup>th</sup> Street to Ohio River; New bridge (4 lanes in each direction) through Queensgate 900 feet west of existing for I-71/I-75 traffic; Rehab existing bridge for local traffic (2 lanes SB and 3 lanes NB); Realign US 50; Improvements to Western and Winchell Avenues	Six lanes in each direction between Kyles Lane and KY 12 <sup>th</sup> Street; local C-D roadway from KY 12 <sup>th</sup> Street to Ohio River; New double deck bridge just west of existing bridge for I-75 (2 lanes NB and SB), 2 lanes SB I-71, two lanes SB local traffic; Rehab existing bridge for NB I-71 (2 lanes), NB local traffic (3 lanes); Reconfigure I-75 through I-71/I-75/US 50 Interchange; From KY 12 <sup>th</sup> Street to Ezzard Charles Drive NB I-75 5 lanes, SB I-75 2 lanes, and local SB C-D roadway 4 lanes; Improvements to Western and Winchell Avenues	Six lanes in each direction between Kyles Lane and KY 12 <sup>th</sup> Street; Local C-D roadway between KY 12 <sup>th</sup> Street and the Ohio River; New double deck bridge just west of the existing bridge I-75 (2 lanes NB and SB), two lanes SB I-71, and two lanes SB local traffic; Rehab existing bridge for NB I-71 (2 lanes) and three lanes for NB local traffic (3 lanes); Reconfigure I-75 through the I-71/I-75/US 50 Interchange; 11 lanes for I-75 and SB local traffic between Ezzard Charles Drive and the Western Hills Viaduct; Improvements to Western and Winchell Avenues	Six lanes in each direction between Kyles Lane and KY 12 <sup>th</sup> Street; Two access points into Covington for both NB and SB traffic; New double-deck bridge just west of the existing Bridge for I-71/I-75 traffic (2 lanes in each direction); Reconfigure I-75 through the I-71/I-75/US 50 Interchange; Between Ezzard Charles Drive and Western Hills Viaduct, SB I-75 6 lanes, NB I-75 5 lanes, and one auxiliary lane to the Western Hills Viaduct; Improvements to Western and Winchell Avenues	Six lanes in each direction between Kyles Lane and KY 12 <sup>th</sup> Street; 2 access points to Covington for NB and SB traffic through a C-D roadway; New double deck bridge just west of the existing bridge for I-75 (2 lanes in each direction), 2 lanes for SB I-71 and 2 lanes for SB local traffic; Rehab existing bridge for NB I-71 (2 lanes) and local traffic (3 lanes); Reconfigure I-75 through the I-71/I-75/US 50 Interchange; I-75 elevated from Ohio River to Linn Street; NB C-D roadway will carry local traffic to Ezzard Charles Drive; Improvements to Western and Winchell Avenues
<b>Noise</b>						
Number of receptor sites where 2035 noise levels will approach or exceed the NAC of 66 dBA for Category B land use (residential)	High noise impacts • All receptor sites will approach or exceed the NAC of 66 dBA in both KY and OH	High noise impacts • All receptor sites will approach or exceed the NAC of 66 dBA in both KY and OH	High noise impacts • All receptor sites will approach or exceed the NAC of 66 dBA in both KY and OH	High noise impacts • All receptor sites will approach or exceed the NAC of 66 dBA in both KY and OH	High noise impacts • All receptor sites will approach or exceed the NAC of 66 dBA in both KY and OH	High noise impacts • All receptor sites will approach or exceed the NAC of 66 dBA in both KY and OH
Number of receptor sites where 2035 noise levels will approach or exceed the NAC of 71 dBA for Category C land use (industrial/commercial)	High noise impacts Noise levels will approach or exceed the NAC of 71 dBA • 49 of 55 receptor sites in KY • “Substantial increase” at 4 receptor sites in KY only • 47 of 55 receptor sites in OH	High noise impacts Noise levels will approach or exceed the NAC of 71 dBA • 50 of 55 receptor sites in KY • 54 of 55 receptor sites in OH	High noise impacts Noise levels will approach or exceed the NAC of 71 dBA • 49 of 55 receptor sites in KY • 51 of 55 receptor sites in OH	High noise impacts Noise levels will approach or exceed the NAC of 71 dBA • 48 of 55 receptor sites in KY • 49 of 55 receptor sites in OH	High noise impacts Noise levels will approach or exceed the NAC of 71 dBA • 49 of 55 receptor sites in KY • 49 of 55 receptor sites in OH	High noise impacts Noise levels will approach or exceed the NAC of 71 dBA • 50 of 55 receptor sites in KY • 49 of 55 receptor sites in OH
<b>Hazardous Materials</b>						
Number of sites recommended for Phase I Environmental Site Assessment	None	51 Sites recommended for Phase I: • 14 Sites in KY • 37 Sites (1 CERCLIS) in OH	29 Sites recommended for Phase I: • 12 Sites in KY • 17 Sites in OH	34 Sites recommended for Phase I: • 12 Sites in KY • 21 Sites in OH	34 Sites recommended for Phase I: • 12 Sites in KY • 22 Sites in OH	36 Sites recommended for Phase I: • 13 Sites in KY • 23 Sites in OH

Conceptual Alternatives Evaluation Matrix						
Impacts	No Build	Alternative B (Former Alternative 2)	Alternative C (Former Alternative 3)	Alternative D (Former Alternative 3)	Alternative E (Former Alternative 3)	Alternative G (Former Alternative 4 Hybrid)
<b>Alternative Description</b>	The No Build Alternative consists of minor, short-term safety and maintenance improvements to the Brent Spence Bridge and I-75 corridor, which would maintain continuing operations. All within existing right of way.	Six lanes each direction between Kyles Lane to KY 12 <sup>th</sup> Street; Local C-D roadway from KY 12 <sup>th</sup> Street to Ohio River; New bridge (4 lanes in each direction) through Queensgate 900 feet west of existing for I-71/I-75 traffic; Rehab existing bridge for local traffic (2 lanes SB and 3 lanes NB); Realign US 50; Improvements to Western and Winchell Avenues	Six lanes in each direction between Kyles Lane and KY 12 <sup>th</sup> Street; local C-D roadway from KY 12 <sup>th</sup> Street to Ohio River; New double deck bridge just west of existing bridge for I-75 (2 lanes NB and SB), 2 lanes SB I-71, two lanes SB local traffic; Rehab existing bridge for NB I-71 (2 lanes), NB local traffic (3 lanes); Reconfigure I-75 through I-71/I-75/US 50 Interchange; From KY 12 <sup>th</sup> Street to Ezzard Charles Drive NB I-75 5 lanes, SB I-75 2 lanes, and local SB C-D roadway 4 lanes; Improvements to Western and Winchell Avenues	Six lanes in each direction between Kyles Lane and KY 12 <sup>th</sup> Street; Local C-D roadway between KY 12 <sup>th</sup> Street and the Ohio River; New double deck bridge just west of the existing bridge I-75 (2 lanes NB and SB), two lanes SB I-71, and two lanes SB local traffic; Rehab existing bridge for NB I-71 (2 lanes) and three lanes for NB local traffic (3 lanes); Reconfigure I-75 through the I-71/I-75/US 50 Interchange; 11 lanes for I-75 and SB local traffic between Ezzard Charles Drive and the Western Hills Viaduct; Improvements to Western and Winchell Avenues	Six lanes in each direction between Kyles Lane and KY 12 <sup>th</sup> Street; Two access points into Covington for both NB and SB traffic; New double-deck bridge just west of the existing Bridge for I-71/I-75 traffic (2 lanes in each direction); Reconfigure I-75 through the I-71/I-75/US 50 Interchange; Between Ezzard Charles Drive and Western Hills Viaduct, SB I-75 6 lanes, NB I-75 5 lanes, and one auxiliary lane to the Western Hills Viaduct; Improvements to Western and Winchell Avenues	Six lanes in each direction between Kyles Lane and KY 12 <sup>th</sup> Street; 2 access points to Covington for NB and SB traffic through a C-D roadway; New double deck bridge just west of the existing bridge for I-75 (2 lanes in each direction), 2 lanes for SB I-71 and 2 lanes for SB local traffic; Rehab existing bridge for NB I-71 (2 lanes) and local traffic (3 lanes); Reconfigure I-75 through the I-71/I-75/US 50 Interchange; I-75 elevated from Ohio River to Linn Street; NB C-D roadway will carry local traffic to Ezzard Charles Drive; Improvements to Western and Winchell Avenues
<b>Traffic</b>						
Existing (2005) levels of service and average daily traffic	Approximately 160,000 vehicles per day in project corridor  LOS range from C to F: • 22 Segments – C • 19 Segments – D • 7 Segment – E or F (includes I-75, I-71, US 50)	N/A	N/A	N/A	N/A	N/A
Future (2035) levels of service along mainline segments (NB = northbound; SB = southbound)	LOS includes I-75 • 16 Segments – D • 8 Segments – E • 19 Segments – F	I-75: • 1 NB segment LOS F north of Dixie Highway • 7 SB segments LOS E  I-71: • NB all segments LOS E or F • SB two segments LOS F	I-75: • 1 NB segment LOS F north of Dixie Highway • 7 SB segments LOS E  I-71: • NB all segments LOS E or F • SB two segments LOS F	I-75: • 1 NB segment LOS E and one LOS F • 6 SB segments LOS E  I-71: • NB all segments LOS E or F • SB two segments LOS F	I-75: • No NB segments LOS E or F north of Dixie Highway • 4 SB segments LOS E  I-71: • NB all segments LOS E or F • SB two segments LOS F	I-75: • 1 NB segment LOS F north of Dixie Highway • 7 SB segments LOS E  I-71: • NB all segments LOS E or F • SB two segments LOS
Future (2035) daily hourly volumes along mainline segments (NB = northbound; SB = southbound)	I-75: • NB ranges from 2,360 – 8,860 • SB ranges from 2,760 – 10,170  I-71/I-75: • NB ranges from 5,310-8,650 • SB ranges from 940-9,160  I-71: • NB ranges from 1,900 – 7,400 • SB ranges from 2,420 – 6,330	I-75: • NB ranges from 2,450 – 8,790 • SB ranges from 2,730 – 9,780  I-71/I-75: • NB ranges from 6,070 -8,910 • SB ranges from 5,900 -10,390  I-71: • NB ranges from 2,510 – 7,530 • SB ranges from 2,310 – 6,490	I-75: • NB ranges from 2,450 – 9,120 • SB ranges from 2,730 – 9,780  I-71/I-75: • NB ranges from 6,010 -8,910 • SB ranges from 5,900 -10,390  I-71: • NB ranges from 2,260 – 7,530 • SB ranges from 2,310 – 6,490	I-75: • NB ranges from 2,450 – 9,020 • SB ranges from 2,730 – 9,840  I-71/I-75: • NB ranges from 6,070 -8,910 • SB ranges from 5,900 -10,390  I-71: • NB ranges from 2,260 – 7,530 • SB ranges from 2,310 – 6,490	I-75: • NB ranges from 2,870 – 8,680; • SB ranges from 2,730 – 9,480  I-71/I-75: • NB ranges from 6,440 – 8,910; • SB ranges from 6,460 – 10,390  I-71: • NB ranges from 2,240 – 7,530; • SB ranges from 2,500 – 6,660	I-75: • NB ranges from 2,450 – 9,280 • SB ranges from 2,730 – 9,820  I-71/I-75: • NB ranges from 5,640 – 8,910 • SB ranges from 5,900 – 10,390  I-71: • NB ranges from 2,240 – 7,530 • SB ranges from 2,310 – 6,490

Conceptual Alternatives Evaluation Matrix						
Impacts	No Build	Alternative B (Former Alternative 2)	Alternative C (Former Alternative 3)	Alternative D (Former Alternative 3)	Alternative E (Former Alternative 3)	Alternative G (Former Alternative 4 Hybrid)
<b>Alternative Description</b>	The No Build Alternative consists of minor, short-term safety and maintenance improvements to the Brent Spence Bridge and I-75 corridor, which would maintain continuing operations. All within existing right of way.	Six lanes each direction between Kyles Lane to KY 12 <sup>th</sup> Street; Local C-D roadway from KY 12 <sup>th</sup> Street to Ohio River; New bridge (4 lanes in each direction) through Queensgate 900 feet west of existing for I-71/I-75 traffic; Rehab existing bridge for local traffic (2 lanes SB and 3 lanes NB); Realign US 50; Improvements to Western and Winchell Avenues	Six lanes in each direction between Kyles Lane and KY 12 <sup>th</sup> Street; local C-D roadway from KY 12 <sup>th</sup> Street to Ohio River; New double deck bridge just west of existing bridge for I-75 (2 lanes NB and SB), 2 lanes SB I-71, two lanes SB local traffic; Rehab existing bridge for NB I-71 (2 lanes), NB local traffic (3 lanes); Reconfigure I-75 through I-71/I-75/US 50 Interchange; From KY 12 <sup>th</sup> Street to Ezzard Charles Drive NB I-75 5 lanes, SB I-75 2 lanes, and local SB C-D roadway 4 lanes; Improvements to Western and Winchell Avenues	Six lanes in each direction between Kyles Lane and KY 12 <sup>th</sup> Street; Local C-D roadway between KY 12 <sup>th</sup> Street and the Ohio River; New double deck bridge just west of the existing bridge I-75 (2 lanes NB and SB), two lanes SB I-71, and two lanes SB local traffic; Rehab existing bridge for NB I-71 (2 lanes) and three lanes for NB local traffic (3 lanes); Reconfigure I-75 through the I-71/I-75/US 50 Interchange; 11 lanes for I-75 and SB local traffic between Ezzard Charles Drive and the Western Hills Viaduct; Improvements to Western and Winchell Avenues	Six lanes in each direction between Kyles Lane and KY 12 <sup>th</sup> Street; Two access points into Covington for both NB and SB traffic; New double-deck bridge just west of the existing Bridge for I-71/I-75 traffic (2 lanes in each direction); Reconfigure I-75 through the I-71/I-75/US 50 Interchange; Between Ezzard Charles Drive and Western Hills Viaduct, SB I-75 6 lanes, NB I-75 5 lanes, and one auxiliary lane to the Western Hills Viaduct; Improvements to Western and Winchell Avenues	Six lanes in each direction between Kyles Lane and KY 12 <sup>th</sup> Street; 2 access points to Covington for NB and SB traffic through a C-D roadway; New double deck bridge just west of the existing bridge for I-75 (2 lanes in each direction), 2 lanes for SB I-71 and 2 lanes for SB local traffic; Rehab existing bridge for NB I-71 (2 lanes) and local traffic (3 lanes); Reconfigure I-75 through the I-71/I-75/US 50 Interchange; I-75 elevated from Ohio River to Linn Street; NB C-D roadway will carry local traffic to Ezzard Charles Drive; Improvements to Western and Winchell Avenues
<b>Maintenance of Traffic and Constructability</b>	N/A	<ul style="list-style-type: none"> <li>Access and logistics improved over existing alignment</li> <li>Concerns of access and logistics for constructing I-71 connector ramps</li> <li>Issues related to disruption and delays due to encountering hazardous materials, unknown utilities, buried objects</li> <li>Concern with realignment of transmission lines</li> <li>Need to determine slope stability on south side of Ohio River</li> </ul>	<ul style="list-style-type: none"> <li>Contractors would have limited space for access and logistics</li> <li>Transportation elements reduced to "open" areas of construction</li> <li>Issue with construction footprint in the area of I-71/I-75/US 50 would be clear due to existing transportation facility construction</li> </ul>	<ul style="list-style-type: none"> <li>Contractors would have limited space for access and logistics</li> <li>Transportation elements reduced to "open" areas of construction</li> <li>Issue with construction footprint in the area of I-71/I-75/US 50 would be clear due to existing transportation facility construction</li> </ul>	<ul style="list-style-type: none"> <li>Contractors would have limited space for access and logistics</li> <li>Transportation elements reduced to "open" areas of construction</li> <li>Issue with construction footprint in the area of I-71/I-75/US 50 would be clear due to existing transportation facility construction</li> </ul>	<ul style="list-style-type: none"> <li>Contractors would have limited space for access and logistics</li> <li>Transportation elements reduced to "open" areas of construction</li> <li>Issue with construction footprint in the area of I-71/I-75/US 50 would be clear due to existing transportation facility construction</li> </ul>
<b>Signage</b>	No change	<ul style="list-style-type: none"> <li>New signage required on local streets</li> <li>Final signage plans to include signs outside of project limits</li> <li>Vertical clearance to accommodate signage for double-deck bridge and flyover ramps between OH 2<sup>nd</sup> and 8<sup>th</sup> streets</li> <li>No signage problems are anticipated for any of the alternatives</li> </ul>				
<b>Utilities</b>						
Number of utilities impacted	None	<ul style="list-style-type: none"> <li>58 Individual facilities identified. 46 are below ground and 12 are above ground</li> <li>Does not impact the Duke Energy Sub-station near Longworth Hall</li> <li>Requires relocation of 5 high voltage transmission cables</li> </ul>	<ul style="list-style-type: none"> <li>52 Individual facilities identified. 45 are below ground and 7 are above ground</li> <li>Impacts to portion of the Duke Energy Sub-station near Longworth Hall</li> <li>Does not impact high voltage transmission cables</li> </ul>	<ul style="list-style-type: none"> <li>52 Individual facilities identified. 45 are below ground and 7 are above ground</li> <li>Impacts to portion of the Duke Energy Sub-station near Longworth Hall</li> <li>Does not impact high voltage transmission cables</li> </ul>	<ul style="list-style-type: none"> <li>52 Individual facilities identified. 45 are below ground and 7 are above ground</li> <li>Impacts to portion of the Duke Energy Sub-station near Longworth Hall</li> <li>Does not impact high voltage transmission cables</li> </ul>	<ul style="list-style-type: none"> <li>52 Individual facilities identified. 45 are below ground and 7 are above ground</li> <li>Impacts to portion of the Duke Energy Sub-station near Longworth Hall</li> <li>Does not impact high voltage transmission cables</li> </ul>
Utility relocation costs (2012 with inflation) (does not include right of way costs)	N/A	Duke Energy \$175.0 million (ranges from \$42.0 – 175.0 million)	Duke Energy \$39.4 million	Duke Energy \$39.4 million	Duke Energy \$39.4 million	Duke Energy \$39.4 million

Conceptual Alternatives Evaluation Matrix						
Impacts	No Build	Alternative B (Former Alternative 2)	Alternative C (Former Alternative 3)	Alternative D (Former Alternative 3)	Alternative E (Former Alternative 3)	Alternative G (Former Alternative 4 Hybrid)
<b>Alternative Description</b>	The No Build Alternative consists of minor, short-term safety and maintenance improvements to the Brent Spence Bridge and I-75 corridor, which would maintain continuing operations. All within existing right of way.	Six lanes each direction between Kyles Lane to KY 12 <sup>th</sup> Street; Local C-D roadway from KY 12 <sup>th</sup> Street to Ohio River; New bridge (4 lanes in each direction) through Queensgate 900 feet west of existing for I-71/I-75 traffic; Rehab existing bridge for local traffic (2 lanes SB and 3 lanes NB); Realign US 50; Improvements to Western and Winchell Avenues	Six lanes in each direction between Kyles Lane and KY 12 <sup>th</sup> Street; local C-D roadway from KY 12 <sup>th</sup> Street to Ohio River; New double deck bridge just west of existing bridge for I-75 (2 lanes NB and SB), 2 lanes SB I-71, two lanes SB local traffic; Rehab existing bridge for NB I-71 (2 lanes), NB local traffic (3 lanes); Reconfigure I-75 through I-71/I-75/US 50 Interchange; From KY 12 <sup>th</sup> Street to Ezzard Charles Drive NB I-75 5 lanes, SB I-75 2 lanes, and local SB C-D roadway 4 lanes; Improvements to Western and Winchell Avenues	Six lanes in each direction between Kyles Lane and KY 12 <sup>th</sup> Street; Local C-D roadway between KY 12 <sup>th</sup> Street and the Ohio River; New double deck bridge just west of the existing bridge I-75 (2 lanes NB and SB), two lanes SB I-71, and two lanes SB local traffic; Rehab existing bridge for NB I-71 (2 lanes) and three lanes for NB local traffic (3 lanes); Reconfigure I-75 through the I-71/I-75/US 50 Interchange; 11 lanes for I-75 and SB local traffic between Ezzard Charles Drive and the Western Hills Viaduct; Improvements to Western and Winchell Avenues	Six lanes in each direction between Kyles Lane and KY 12 <sup>th</sup> Street; Two access points into Covington for both NB and SB traffic; New double-deck bridge just west of the existing Bridge for I-71/I-75 traffic (2 lanes in each direction); Reconfigure I-75 through the I-71/I-75/US 50 Interchange; Between Ezzard Charles Drive and Western Hills Viaduct, SB I-75 6 lanes, NB I-75 5 lanes, and one auxiliary lane to the Western Hills Viaduct; Improvements to Western and Winchell Avenues	Six lanes in each direction between Kyles Lane and KY 12 <sup>th</sup> Street; 2 access points to Covington for NB and SB traffic through a C-D roadway; New double deck bridge just west of the existing bridge for I-75 (2 lanes in each direction), 2 lanes for SB I-71 and 2 lanes for SB local traffic; Rehab existing bridge for NB I-71 (2 lanes) and local traffic (3 lanes); Reconfigure I-75 through the I-71/I-75/US 50 Interchange; I-75 elevated from Ohio River to Linn Street; NB C-D roadway will carry local traffic to Ezzard Charles Drive; Improvements to Western and Winchell Avenues
<b>Cost Estimates (in millions)</b>						
Estimated Right of way costs (2012 with inflation)	N/A	Kentucky: \$18.4 Ohio: \$46.5 Subtotal: \$64.9	Kentucky: \$2.5 Ohio: \$15.5 Subtotal: \$18.0	Kentucky: \$2.4 Ohio: \$12.1 Subtotal: \$14.5	Kentucky: \$2.4 Ohio: \$13.0 Subtotal: \$15.4	Kentucky: \$4.6 Ohio: \$19.9 Subtotal: \$24.5
Estimated Construction Costs (2008 plus 59.5% inflation) <i>*Note: Main span bridge included in Kentucky costs</i>	N/A	Kentucky: \$1,485.4 Ohio: \$880.6 Subtotal: \$2,366.0	Kentucky: \$1,260.4 Ohio: \$752.0 Subtotal: \$2,012.4	Kentucky: \$1,260.4 Ohio: \$752.0 Subtotal: \$2,012.4	Kentucky: \$1,474.1 Ohio: \$809.3 Subtotal: \$2,283.4	Kentucky: \$1,305.3 Ohio: \$1,079.3 Subtotal: \$2,384.6
Estimated Utilities Costs (relocation and right of way costs with inflation)	N/A	Kentucky: \$91.0 Ohio: \$91.0 Subtotal: \$182.0	Kentucky: \$20.2 Ohio: \$20.2 Subtotal: \$40.4	Kentucky: \$20.2 Ohio: \$20.2 Subtotal: \$40.4	Kentucky: \$20.2 Ohio: \$20.2 Subtotal: \$40.4	Kentucky: \$20.2 Ohio: \$20.2 Subtotal: \$40.4
Project Development Costs (with inflation)	N/A	Kentucky: \$151.6 Ohio: \$92.6 Subtotal: \$244.2	Kentucky: \$130.1 Ohio: \$80.3 Subtotal: \$210.4	Kentucky: \$130.1 Ohio: \$80.3 Subtotal: \$210.4	Kentucky: \$150.5 Ohio: \$85.8 Subtotal: \$236.3	Kentucky: \$134.4 Ohio: \$111.6 Subtotal: \$246.0
<b>Total Estimated Costs</b> <i>*Total estimated costs include construction, real estate, utilities, utilities right of way, and project development costs</i>	N/A	Kentucky: \$1,746.4 Ohio: \$1,110.7 \$2,857.1	Kentucky: \$1,413.2 Ohio: \$868.0 \$2,281.2	Kentucky: \$1,413.1 Ohio: \$864.6 \$2,277.7	Kentucky: \$1,647.2 Ohio: \$928.3 \$2,575.5	Kentucky: \$1,464.5 Ohio: \$1,231.0 \$2,695.5



## **8.0 REFERENCES**

- City of Cincinnati, Ohio. *Queensgate South Redevelopment Plan*. September 25, 1996.
- City of Cincinnati, Ohio. *Queensgate Area Issues, Considerations and Recommendations for Implementation of the Brent Spence Bridge Project (HAM-71/75-0.00/0.22)*. September 23, 2008.
- Federal Highway Administration. *Manual on Uniform Traffic Control Devices for Streets and Highways, 2003 Edition*. 2007.
- Grubb and Ellis/West Shell Commercial. *Industrial Market Snapshot Greater Cincinnati Fourth Quarter 2008*. February 2009.
- Kentucky Transportation Cabinet, Division of Planning. *Statewide Transportation Plan FY 1999-2018*. December, 1999.
- Kentucky Transportation Cabinet, Division of Planning. *Feasibility and Constructability Study of the Replacement/Rehabilitation of the Brent Spence Bridge*. 2005.
- Kentucky Transportation Cabinet. *Highway Design Manual*. January, 2006.
- Kentucky Transportation Cabinet, Division of Program Management. *Recommended Six-year Transportation Plan FY 2007-2012*. May, 2006.
- KMK Consulting Company LLC, *et al.* *GO Cincinnati Growth and Opportunities for the City of Cincinnati*. January, 2008.
- Northern Kentucky Area Planning Commission. *Areawide Comprehensive Plan*. Updated December 13, 2006.
- Ohio Department of Transportation. *Access Ohio*. 1993.
- Ohio Department of Transportation. *Access Ohio 2004-2030*. November, 2004.
- Ohio Department of Transportation, Office of Urban and Corridor Planning, Office of Environmental Services, Office of Production. *Project Development Process*. November, 2004
- Ohio Department of Transportation. *Location and Design Manual*. October, 2006.
- Ohio Department of Transportation. *Procedure for Construction Budget Estimating*. January, 2008.
- Ohio-Kentucky-Indiana Regional Council of Governments. *OKI Policy for Environmental Justice*. April, 2003.
- Ohio-Kentucky-Indiana Regional Council of Governments / Miami Valley regional Planning Commission. *North-South Transportation Initiative*. February, 2004.

**ODOT PID 75119**  
**KYTC Item No. 6-17**  
**Conceptual Alternatives Study**

---

Ohio-Kentucky-Indiana Regional Council of Governments. *Transportation Improvement Program 2008-2011*. April, 2007.

Ohio-Kentucky-Indiana Regional Council of Governments. *2030 Regional Transportation Plan Update*. June, 2008.

PB Americas, Inc. *Brent Spence Bridge Replacement/Rehabilitation Project Public Involvement Plan*. October, 2005.

PB Americas, Inc. *Red Flag Summary*. December, 2005.

PB Americas, Inc. *Existing and Future Conditions Report*. February, 2006.

PB Americas, Inc. *Planning Study Report*. September, 2006.

PB Americas, Inc. *Relocation Assistance Program Conceptual Survey*. January, 2007.

PB Americas, Inc. *Conceptual Stage Relocation Report*. February, 2007.

PB Americas, Inc. *Ecological Survey Report (KYTC Project No. 6-17)*. February, 2007.

PB Americas, Inc. *Level One Ecological Survey Report (ODOT PID 75119)*. February, 2007.

PB Americas, Inc. *Environmental Site Assessment Screening*. April, 2007.

PB Americas, Inc. *Phase I History/Architecture Survey Report: Kenton County, Kentucky (March 2007; revised November 2008)*

PB Americas, Inc. *Phase I History/Architecture Survey Report: Hamilton County, Ohio (June 2007)*

PB Americas, Inc. *Phase II History/Architecture Investigations: Hamilton County, Ohio (December 2008)*.

PB Americas, Inc. *Report of Preliminary Geotechnical Study: Proposed Queensgate Alignment*. July, 2007.

PB Americas, Inc. *Noise Screening*. February, 2009.

United States Army Corps of Engineers, Waterways Experiment Station. *Corps of Engineers Wetlands Delineation Manual*. January, 1987.

United States Census Bureau. *United States Census 2000*. 2000.

United States Environmental Protection Agency. *Rapid Bioassessment Protocols for Use in Wadeable Streams and Rivers*. 1999.

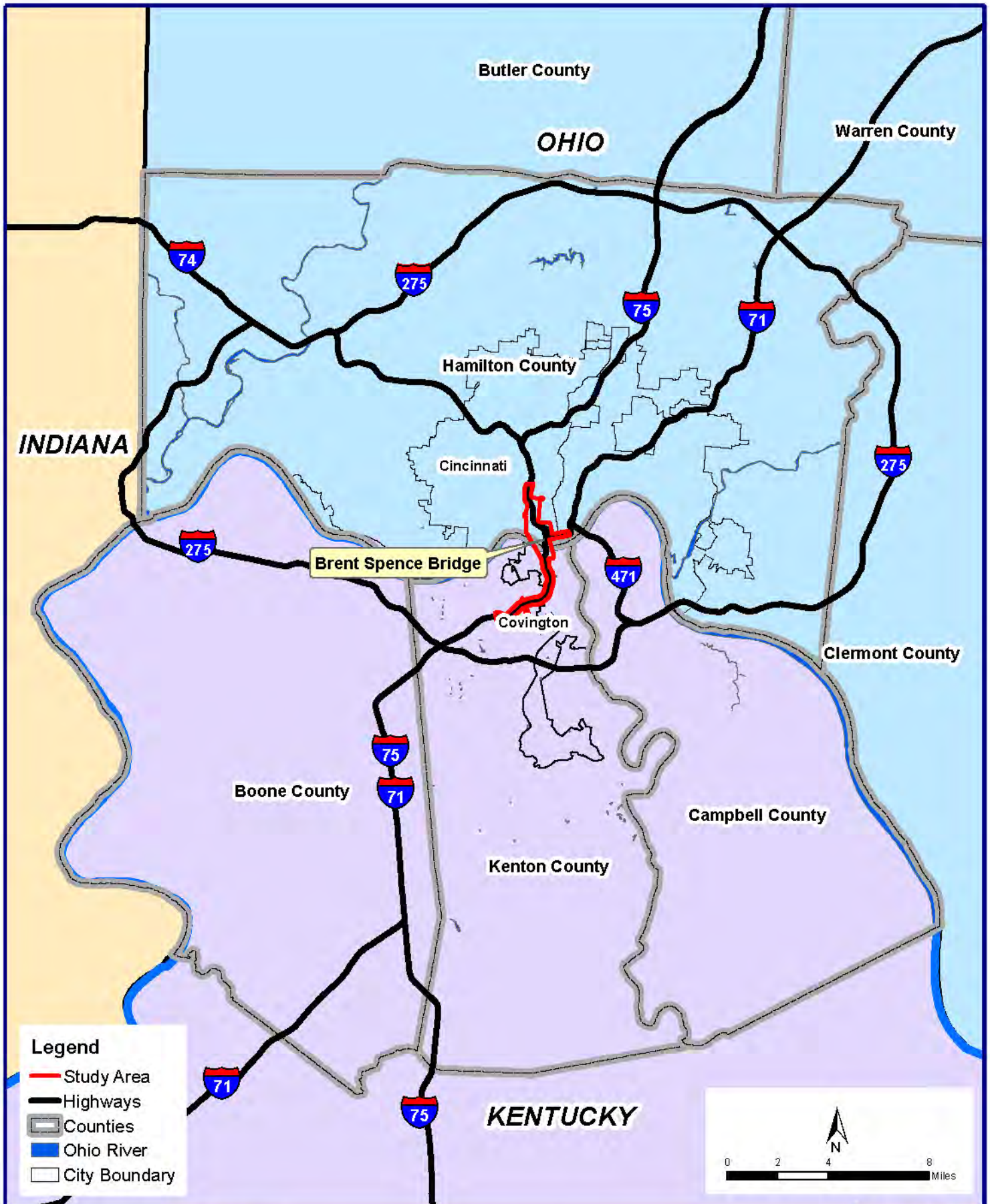

U.S. Department of Transportation  
Federal Highway Administration



REGIONAL MAP

EXHIBIT

1

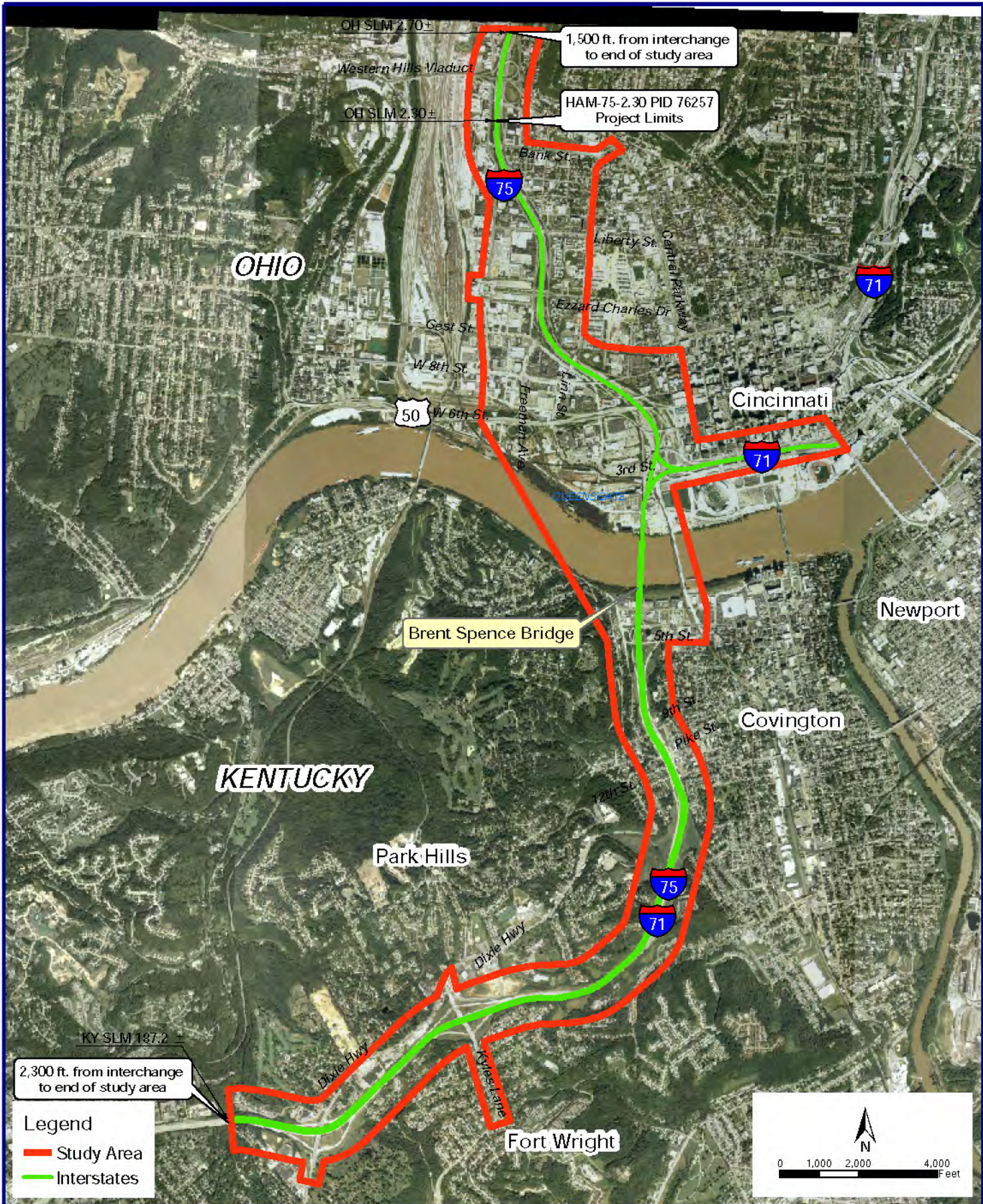

U.S. Department of Transportation  
Federal Highway Administration



STUDY AREA

EXHIBIT

2

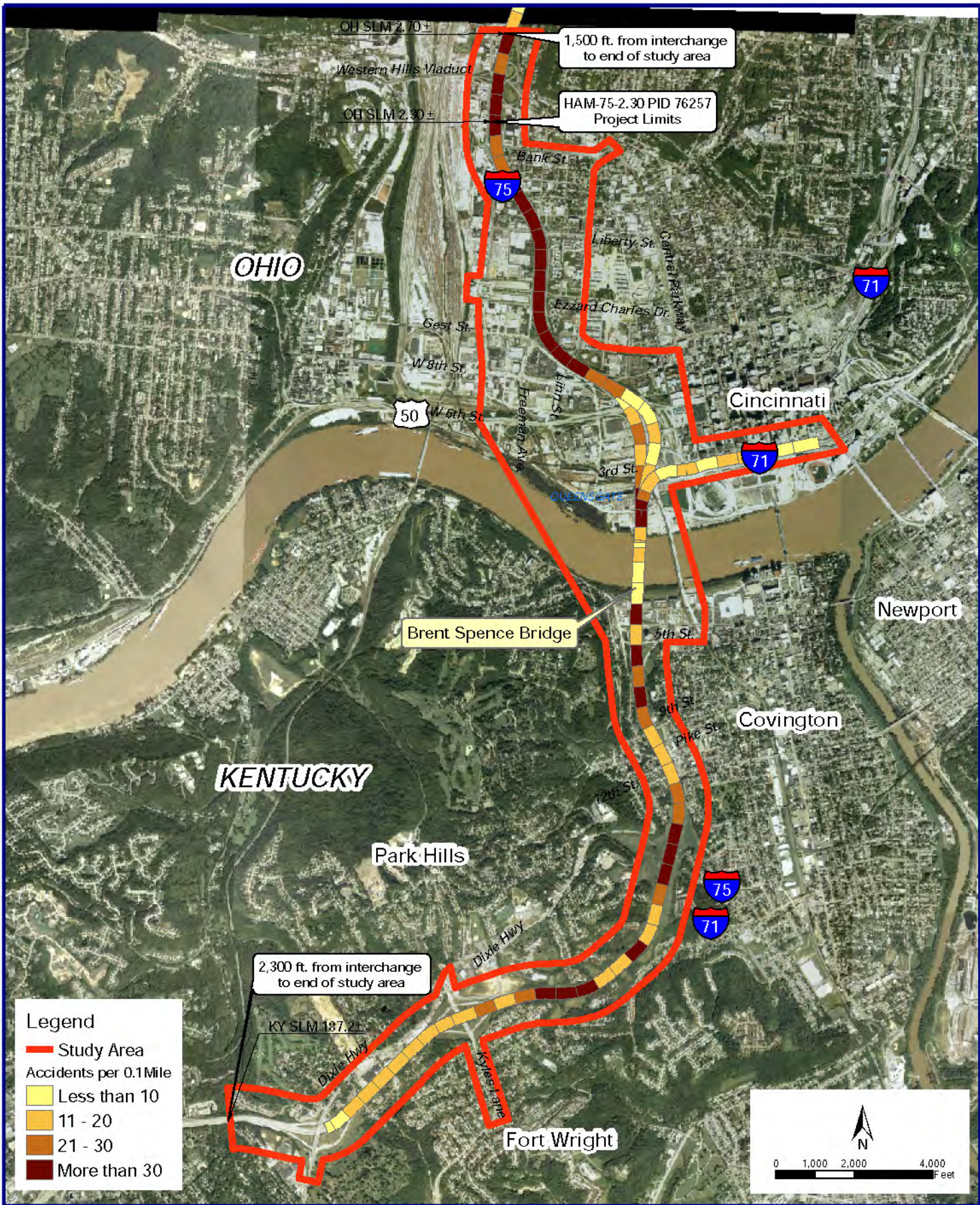

**Legend**

- Study Area
- Accidents per 0.1Mile
- Less than 10
- 11 - 20
- 21 - 30
- More than 30

N

0 1,000 2,000 4,000  
Feet

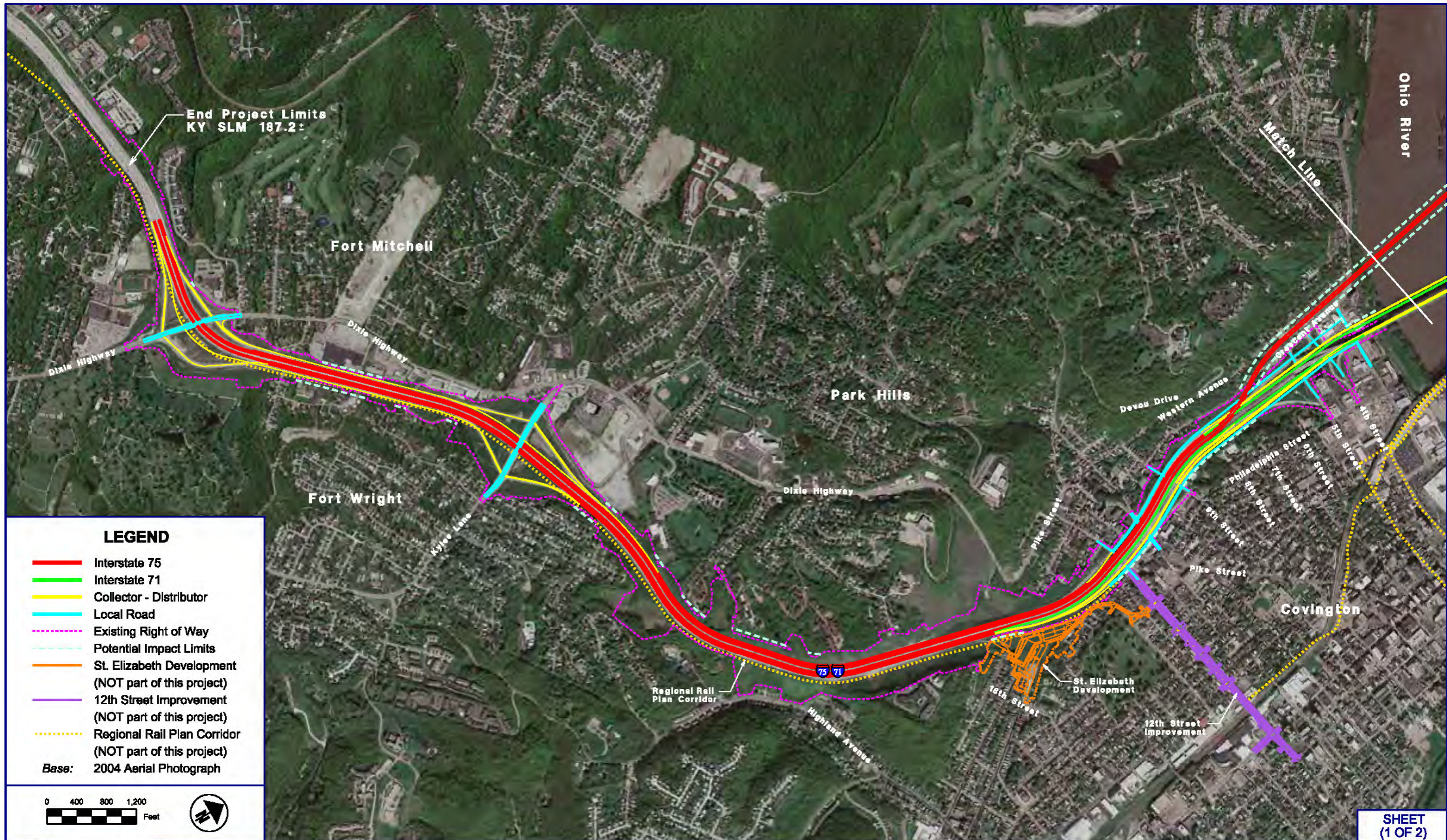

**ALTERNATIVE A  
(KENTUCKY)**

**SHEET  
(1 OF 2)  
EXHIBIT  
4A**



**LEGEND**

- Interstate 75
- Interstate 71
- Collector - Distributor
- US 50
- Local Road
- - - Existing Right of Way
- - - Potential Impact Limits
- Queensgate South Development (NOT part of this project)
- - - Regional Rail Plan Corridor (NOT part of this project)

Base: 2004 Aerial Photograph

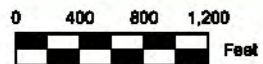

U.S. Department of Transportation  
Federal Highway Administration



Prepared by  
**PARSONS BRINCKERHOFF**

**ALTERNATIVE A  
(OHIO)**

SHEET  
(2 OF 2)

EXHIBIT

4B





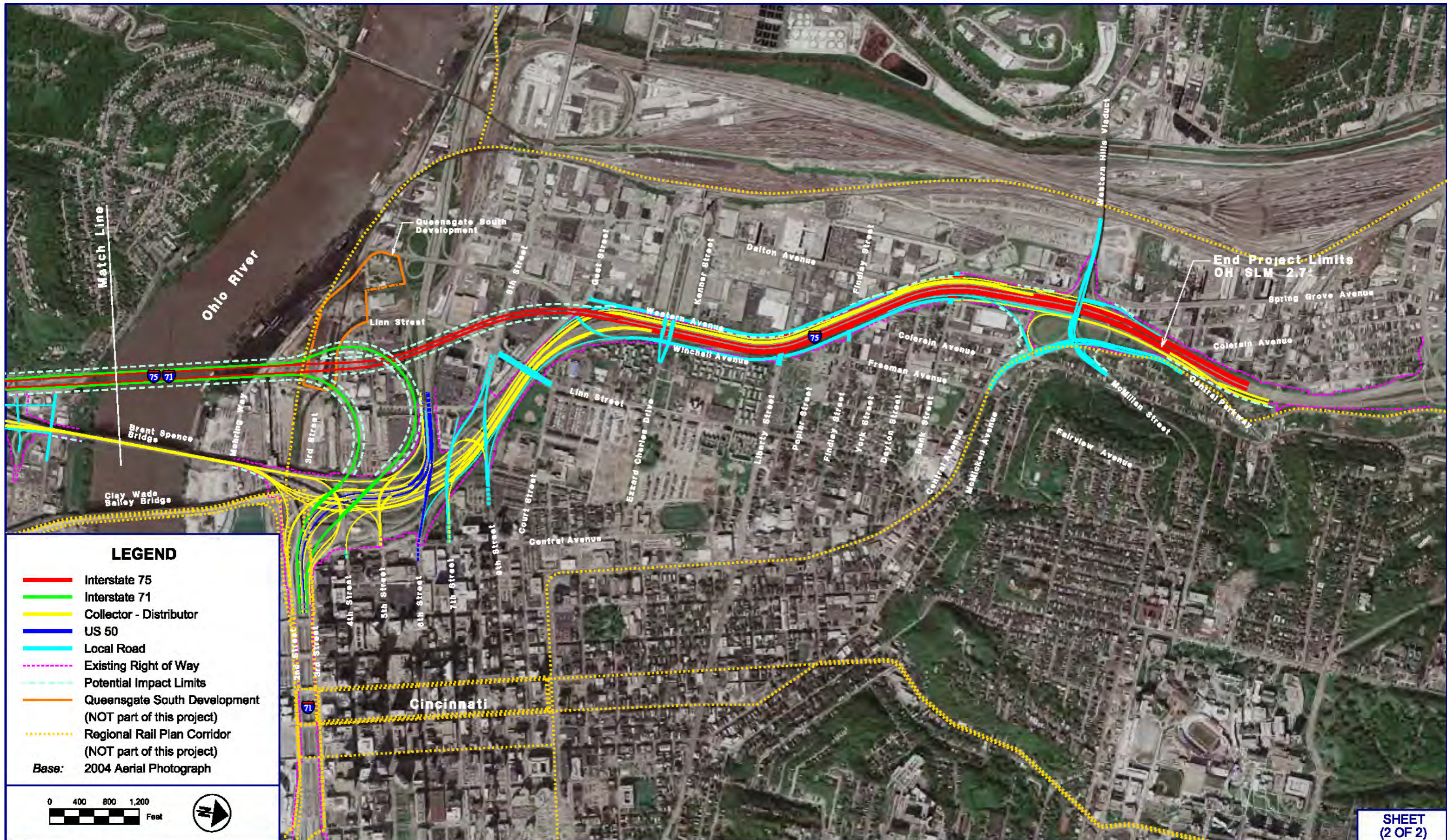

**LEGEND**

- Interstate 75
- Interstate 71
- Collector - Distributor
- US 50
- Local Road
- - - Existing Right of Way
- - - Potential Impact Limits
- Queensgate South Development (NOT part of this project)
- - - Regional Rail Plan Corridor (NOT part of this project)

Base: 2004 Aerial Photograph

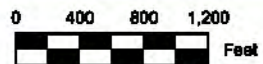

U.S. Department of Transportation  
Federal Highway Administration



Prepared by  
**PARSONS BRINCKERHOFF**

**ALTERNATIVE B  
(OHIO)**

SHEET  
(2 OF 2)

EXHIBIT

5B

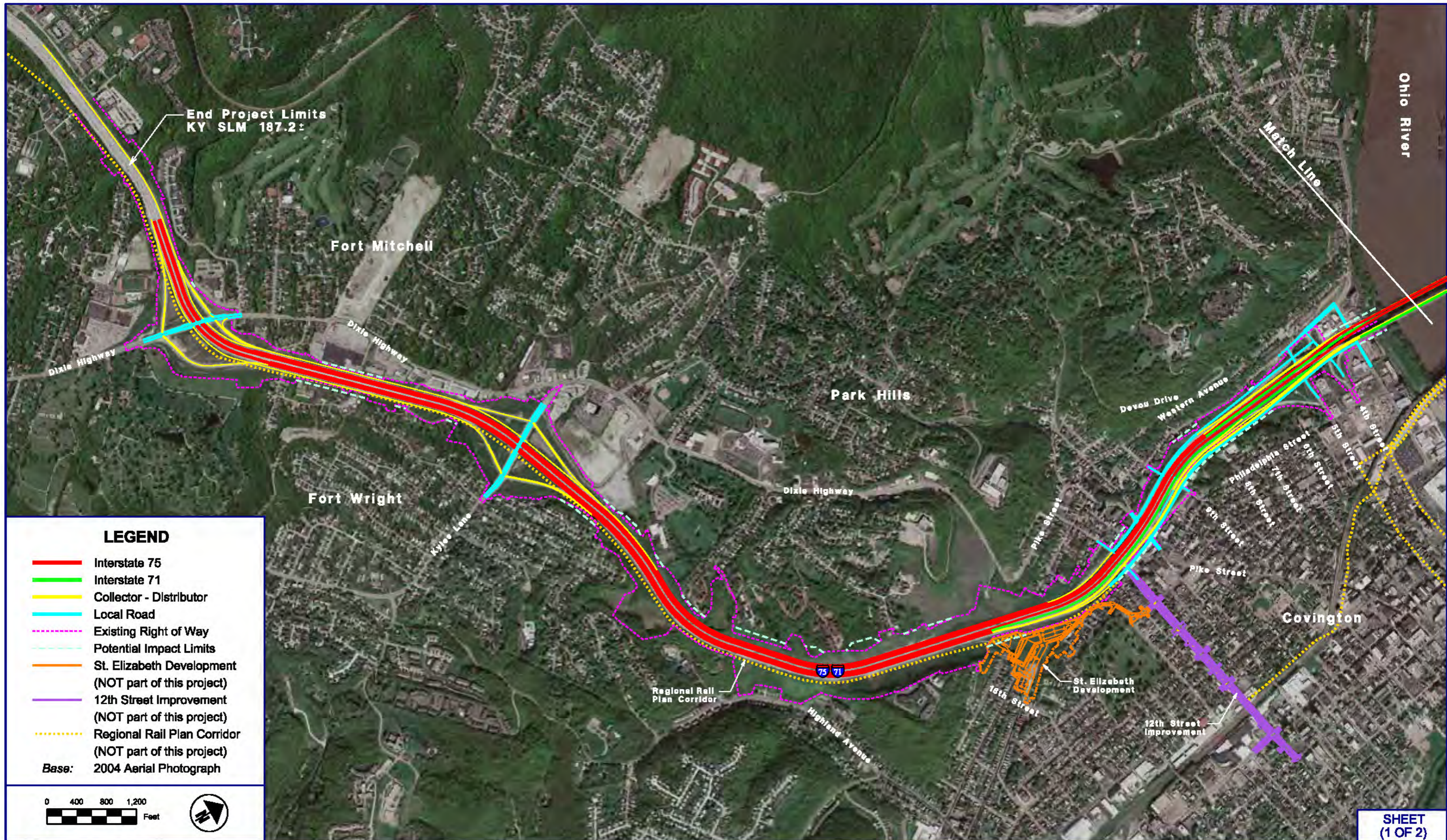

**ALTERNATIVE C  
(KENTUCKY)**

**SHEET  
(1 OF 2)  
EXHIBIT  
6A**



**LEGEND**

- Interstate 75
- Interstate 71
- Collector - Distributor
- US 50
- Local Road
- Existing Right of Way
- Potential Impact Limits
- Queensgate South Development (NOT part of this project)
- Regional Rail Plan Corridor (NOT part of this project)

Base: 2004 Aerial Photograph

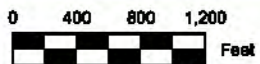

U.S. Department of Transportation  
Federal Highway Administration



**ALTERNATIVE C  
(OHIO)**

SHEET  
(2 OF 2)

EXHIBIT

6B

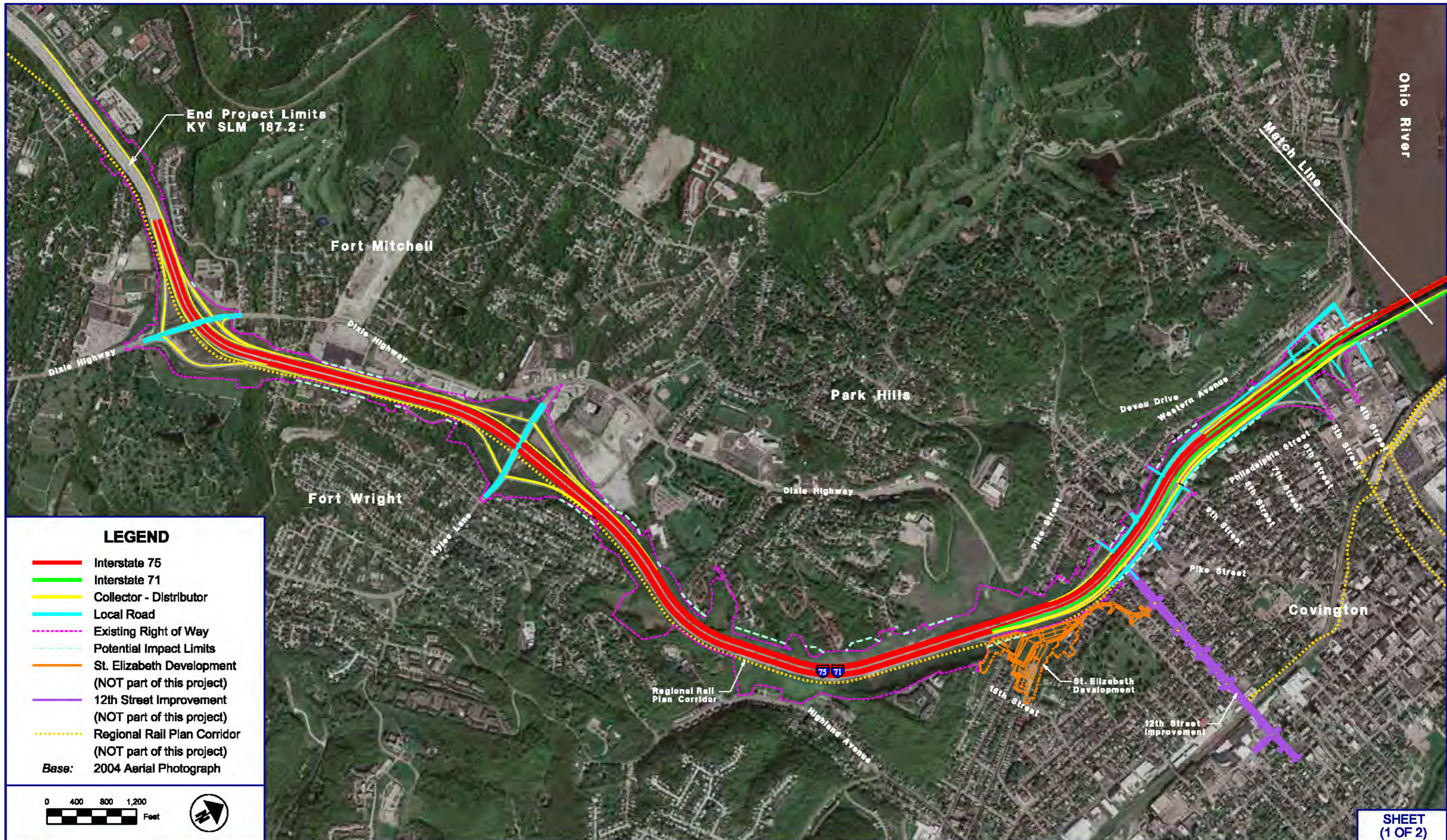

**ALTERNATIVE D  
(KENTUCKY)**

**SHEET  
(1 OF 2)  
EXHIBIT  
7A**



**LEGEND**

- Interstate 75
- Interstate 71
- Collector - Distributor
- US 50
- Local Road
- Existing Right of Way
- Potential Impact Limits
- Queensgate South Development (NOT part of this project)
- Regional Rail Plan Corridor (NOT part of this project)

Base: 2004 Aerial Photograph

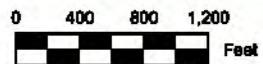

U.S. Department of Transportation  
Federal Highway Administration



Prepared by  
**PARSONS BRINCKERHOFF**

**ALTERNATIVE D  
(OHIO)**

**SHEET  
(2 OF 2)**

**EXHIBIT**

**7B**

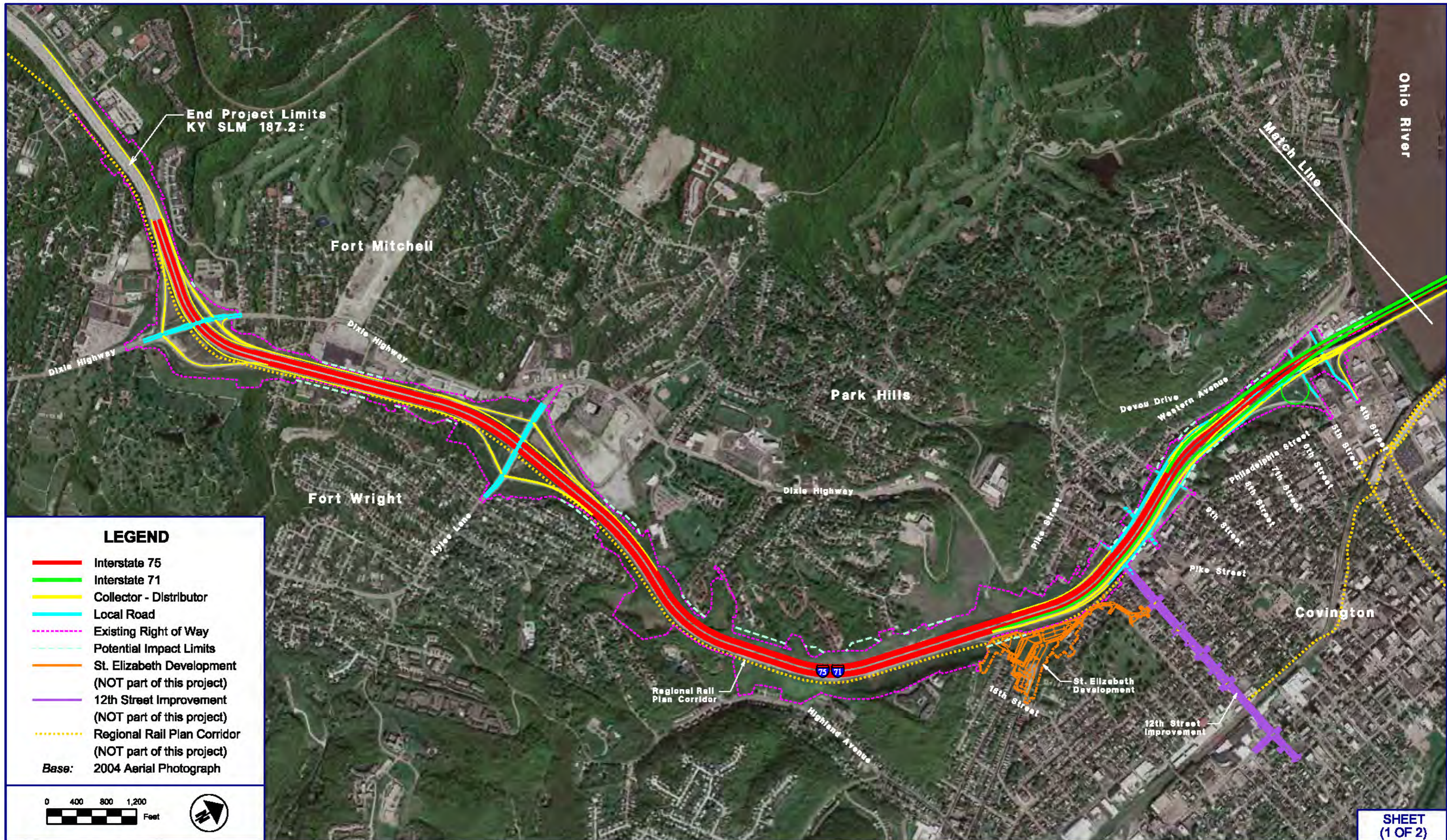

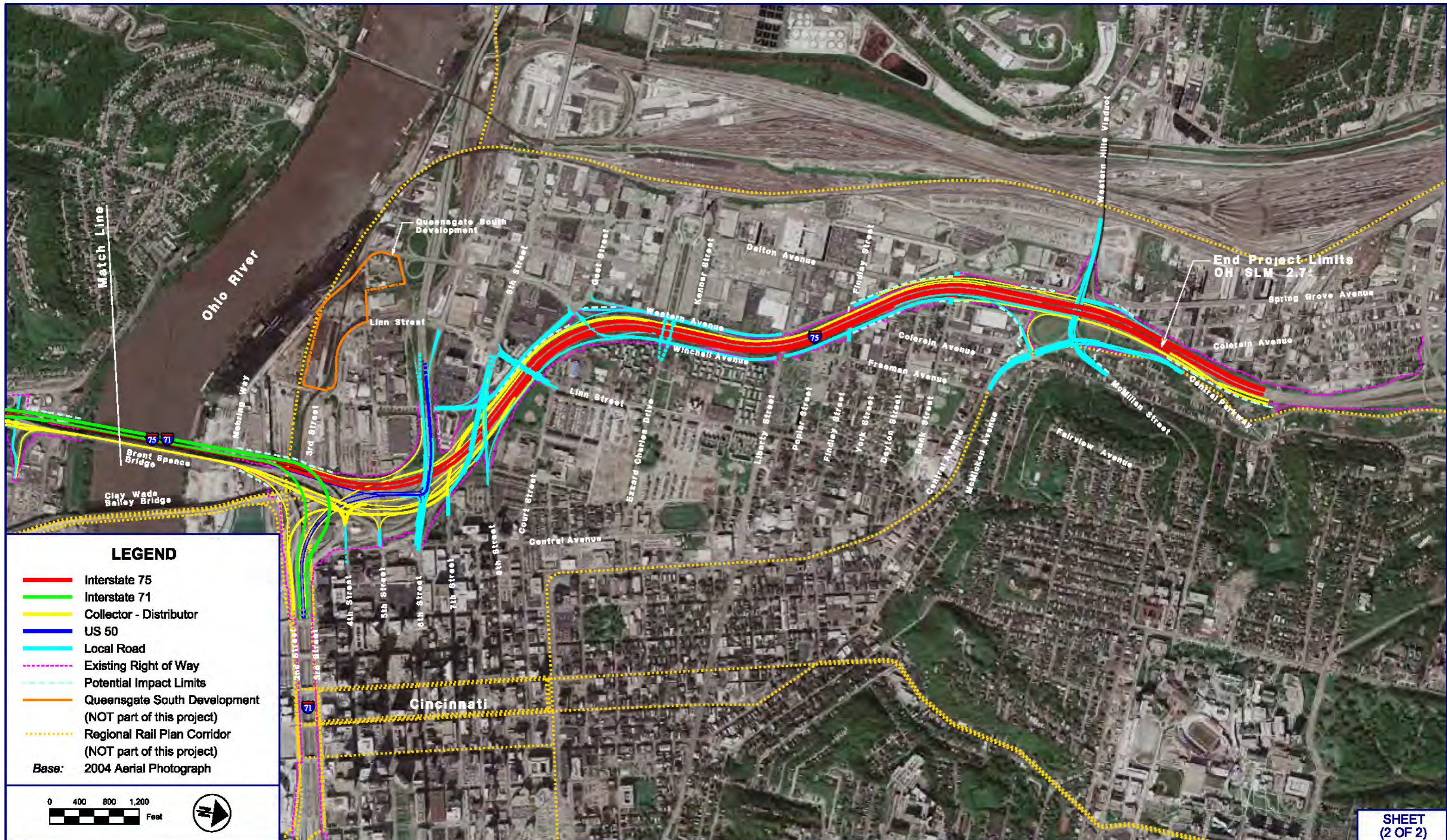

**ALTERNATIVE E  
(OHIO)**

SHEET  
(2 OF 2)  
EXHIBIT  
8B

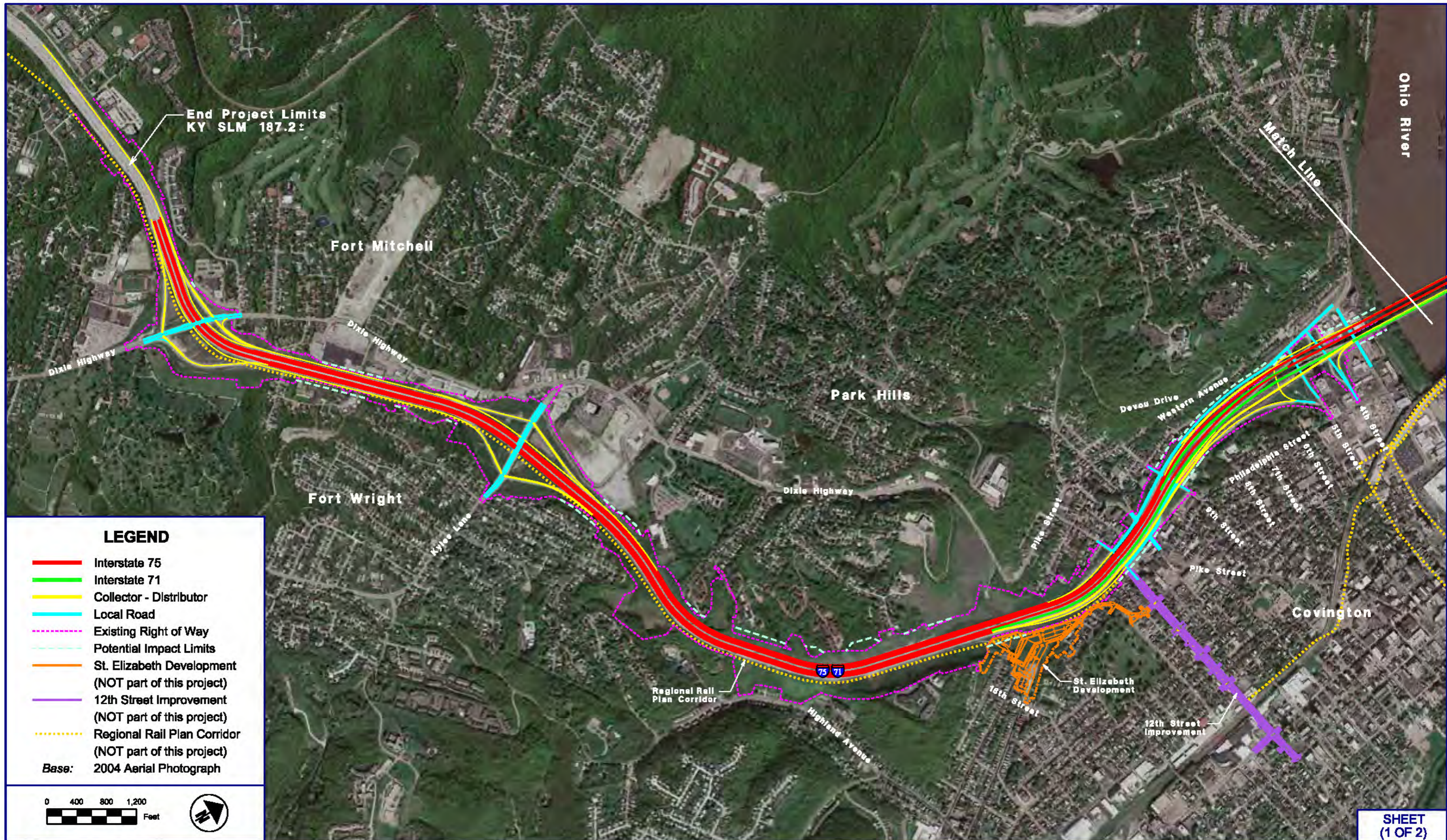

**ALTERNATIVE F  
(KENTUCKY)**

**SHEET  
(1 OF 2)  
EXHIBIT  
9A**





**LEGEND**

- Interstate 75
- Interstate 71
- Collector - Distributor
- US 50
- Local Road
- Existing Right of Way
- Potential Impact Limits
- Queensgate South Development (NOT part of this project)
- Regional Rail Plan Corridor (NOT part of this project)

Base: 2004 Aerial Photograph

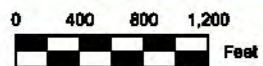

U.S. Department of Transportation  
Federal Highway Administration



Prepared by  
**PARSONS BRINCKERHOFF**

**ALTERNATIVE F  
(OHIO)**

SHEET  
(2 OF 2)

EXHIBIT

9B

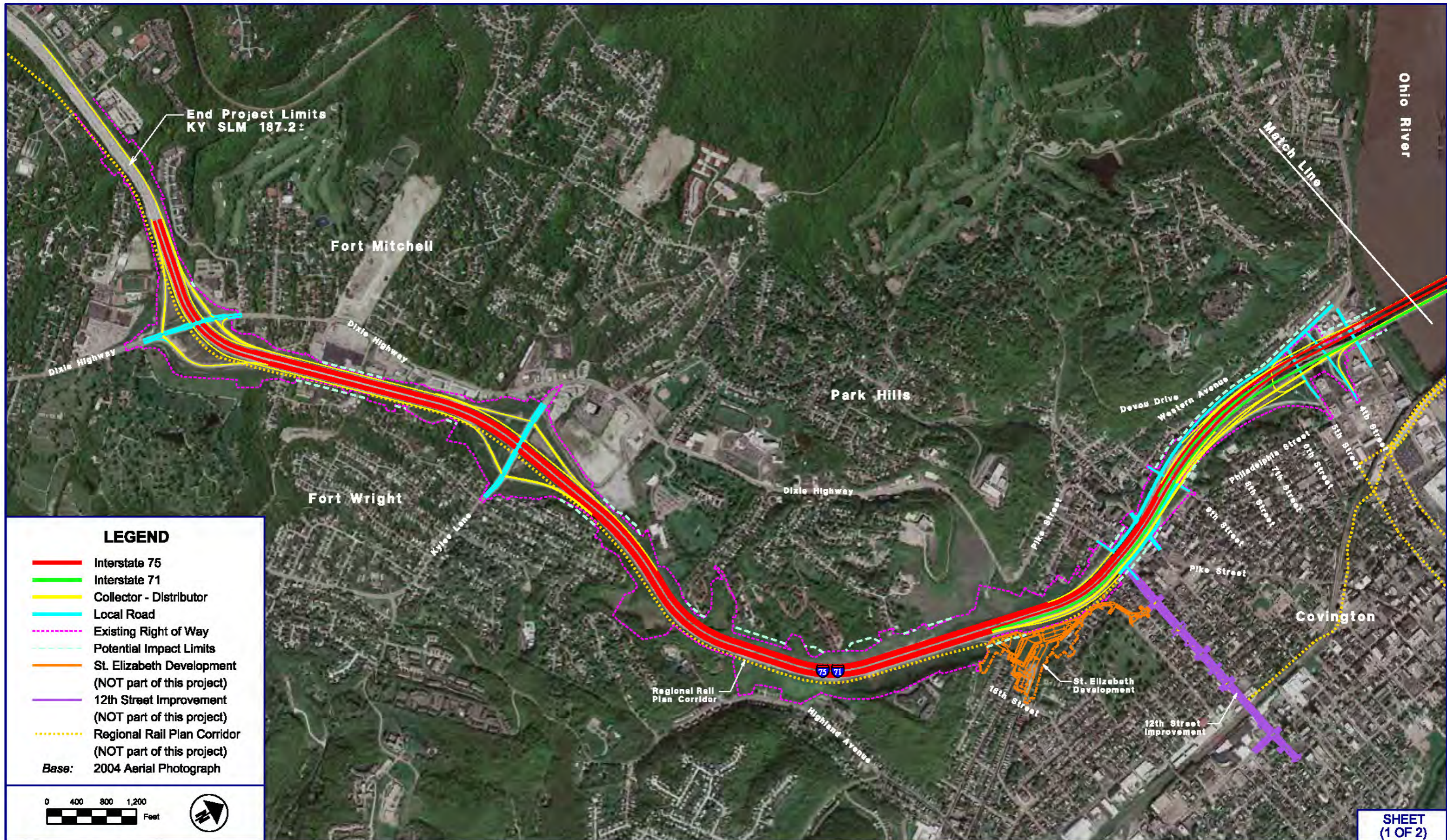

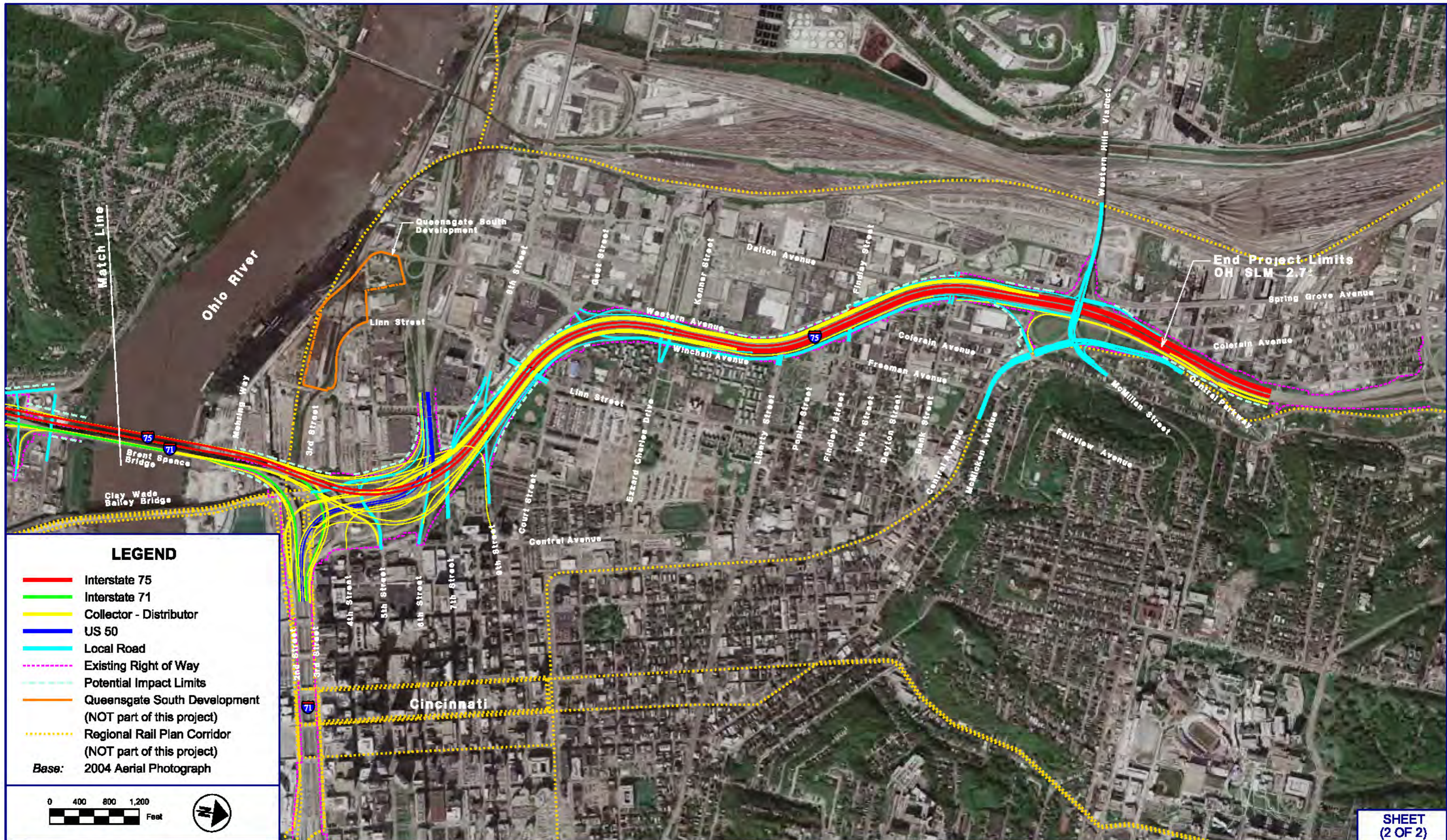

**LEGEND**

- Interstate 75
  - Interstate 71
  - Collector - Distributor
  - US 50
  - Local Road
  - Existing Right of Way
  - Potential Impact Limits
  - Queensgate South Development (NOT part of this project)
  - Regional Rail Plan Corridor (NOT part of this project)
- Base: 2004 Aerial Photograph



**ALTERNATIVE G  
(OHIO)**

**SHEET  
(2 OF 2)  
EXHIBIT  
10B**

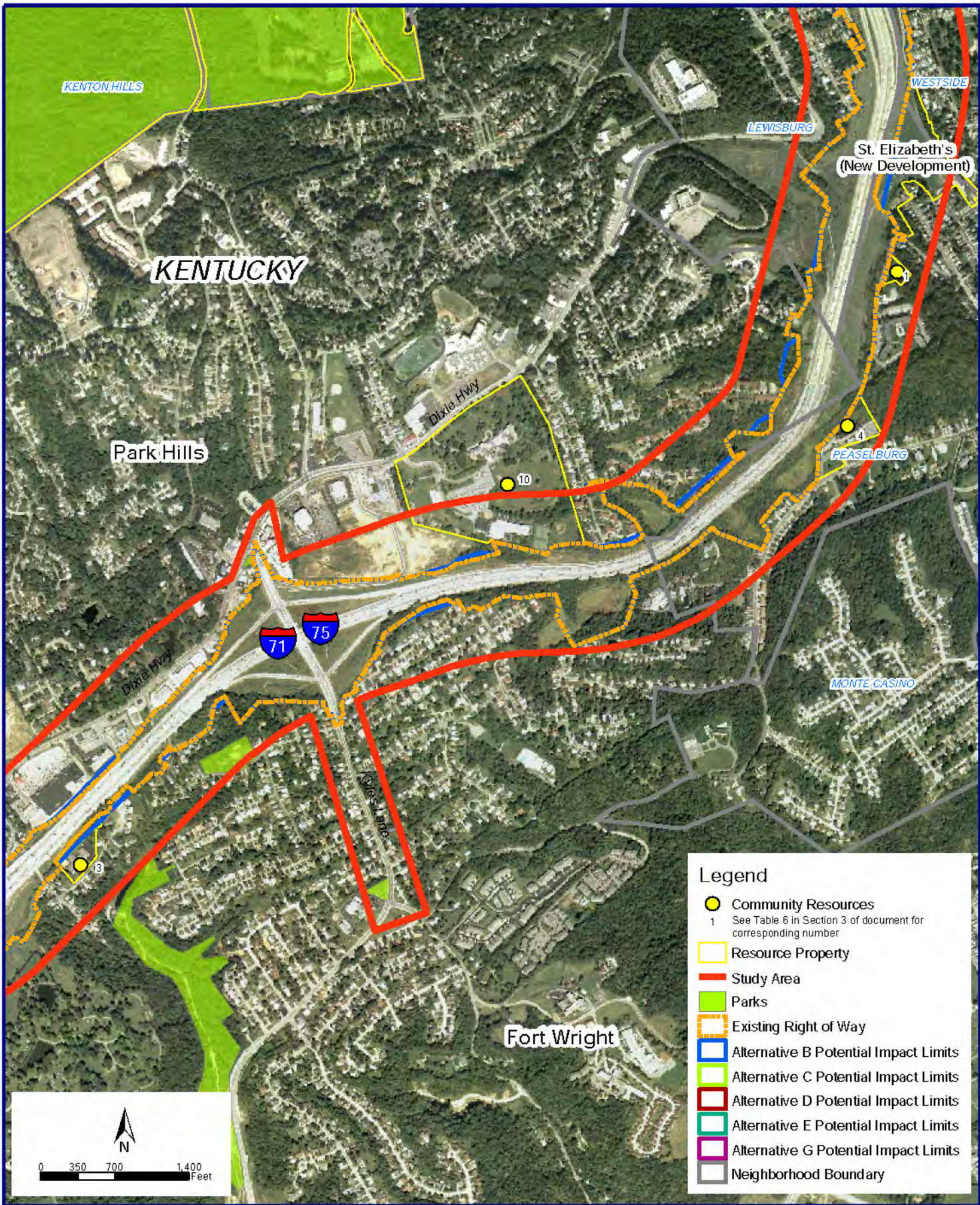

**Legend**

- Community Resources  
1 See Table 6 in Section 3 of document for corresponding number
- Resource Property
- Study Area
- Parks
- Existing Right of Way
- Alternative B Potential Impact Limits
- Alternative C Potential Impact Limits
- Alternative D Potential Impact Limits
- Alternative E Potential Impact Limits
- Alternative G Potential Impact Limits
- Neighborhood Boundary

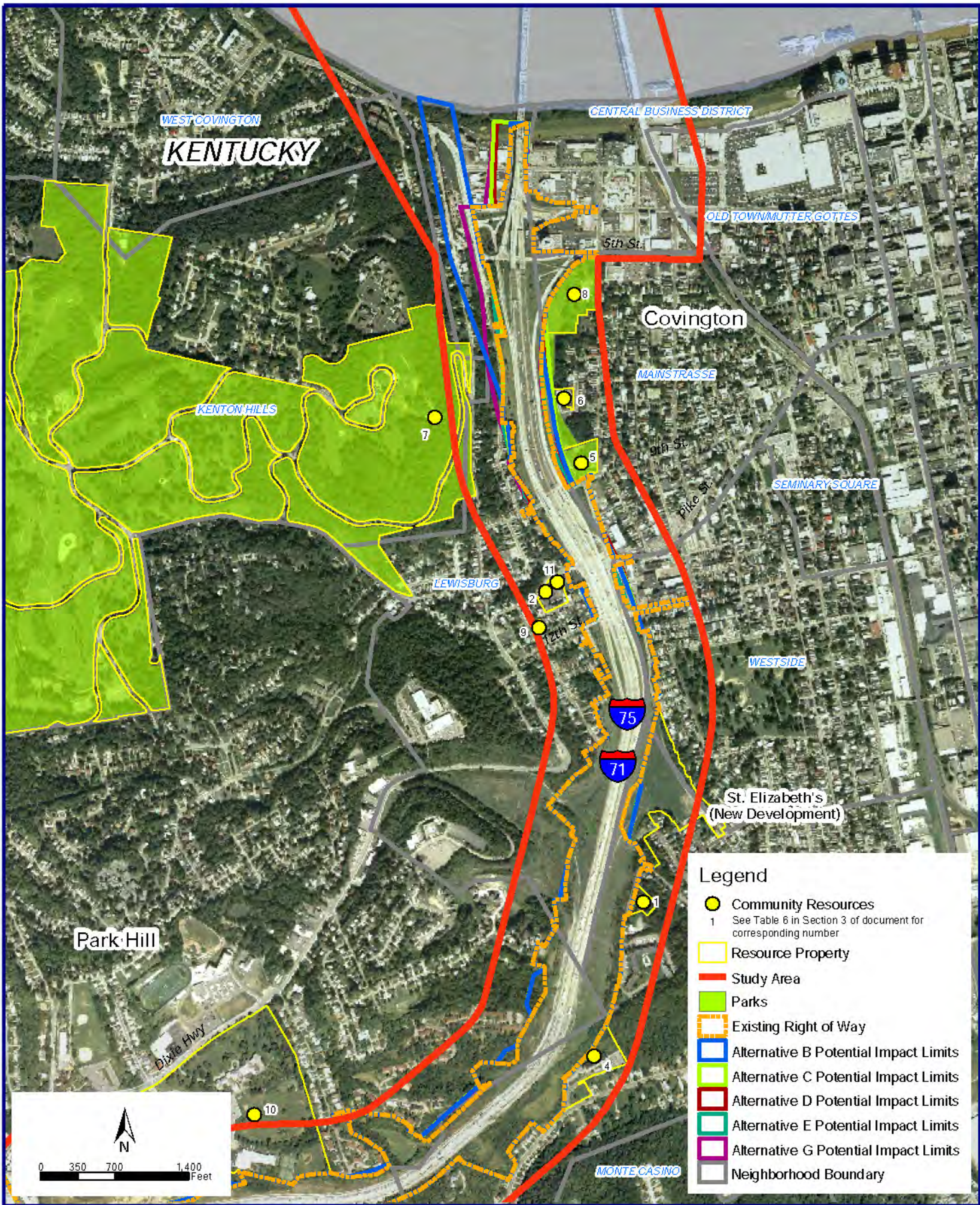

**Legend**

- Community Resources  
1 See Table 6 in Section 3 of document for corresponding number
- Resource Property
- Study Area
- Parks
- Existing Right of Way
- Alternative B Potential Impact Limits
- Alternative C Potential Impact Limits
- Alternative D Potential Impact Limits
- Alternative E Potential Impact Limits
- Alternative G Potential Impact Limits
- Neighborhood Boundary

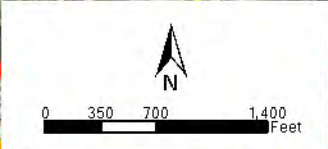

**COMMUNITY FACILITIES & RESOURCES  
(KENTUCKY)**

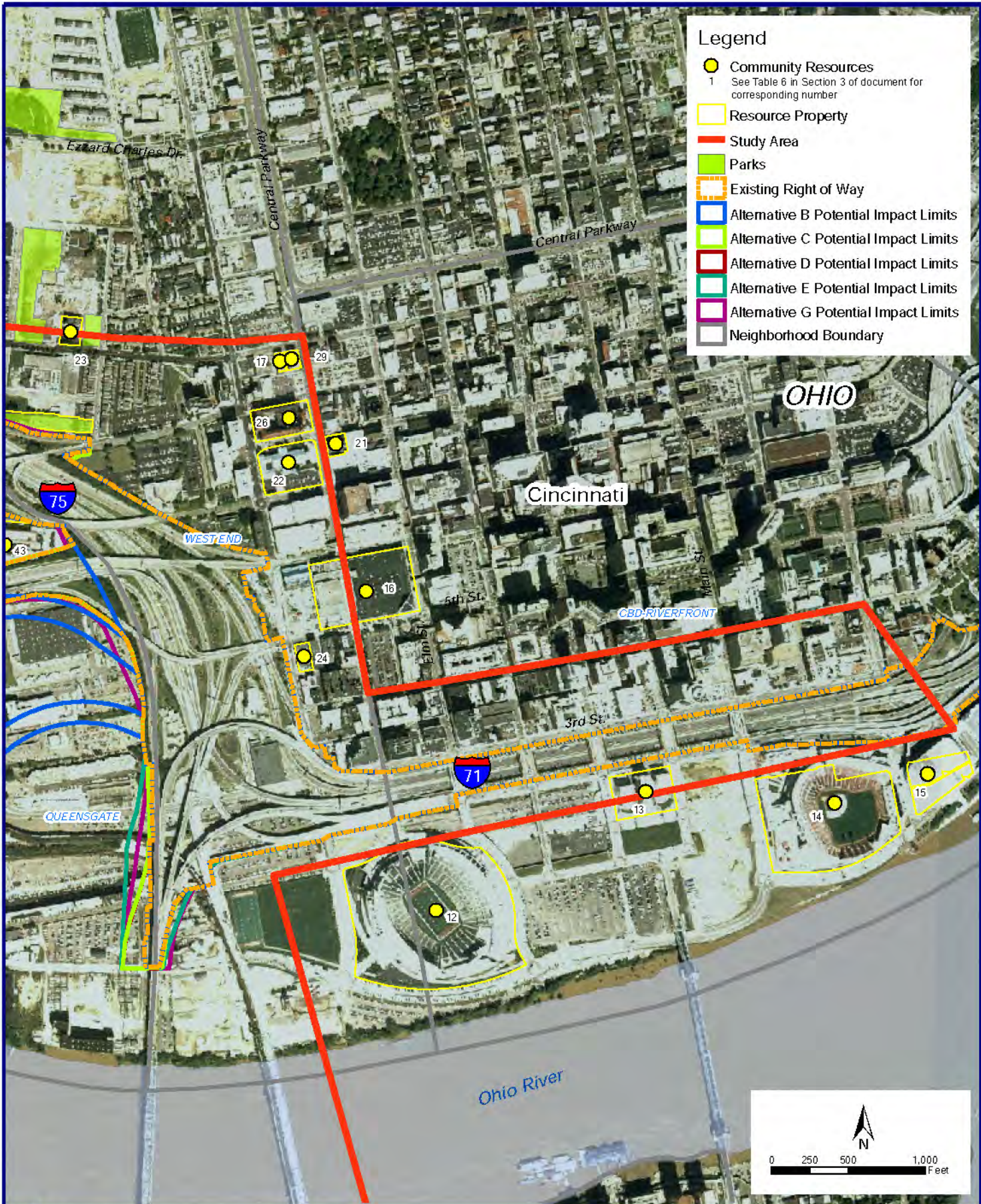

**Legend**

- Community Resources  
1 See Table 6 in Section 3 of document for corresponding number
- Resource Property
- Study Area
- Parks
- Existing Right of Way
- Alternative B Potential Impact Limits
- Alternative C Potential Impact Limits
- Alternative D Potential Impact Limits
- Alternative E Potential Impact Limits
- Alternative G Potential Impact Limits
- Neighborhood Boundary

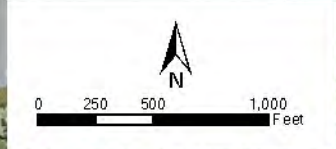

U.S. Department of Transportation  
Federal Highway Administration



**COMMUNITY FACILITIES & RESOURCES  
(OHIO)**

**EXHIBIT  
11C**

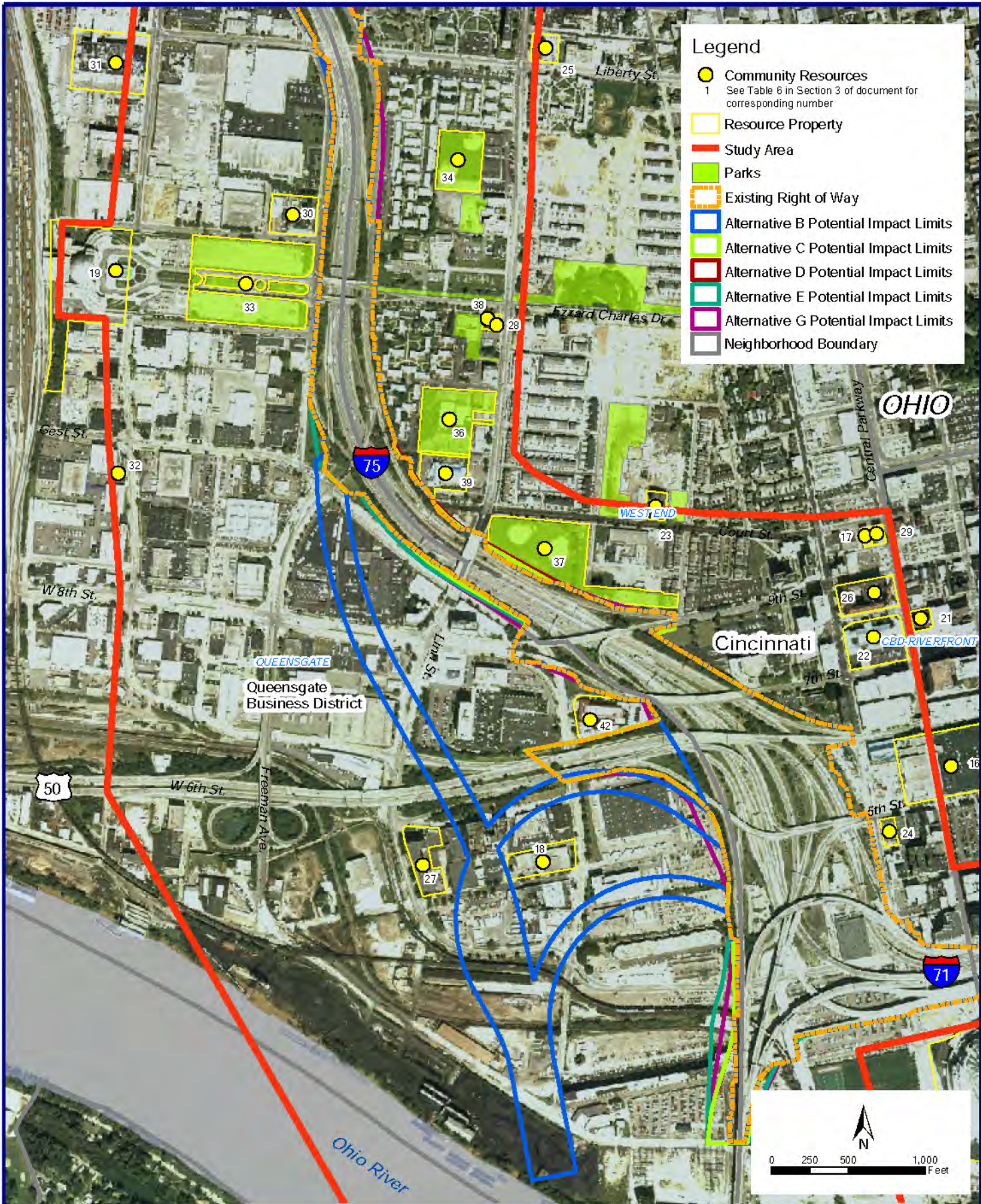

**Legend**

- Community Resources**  
1 See Table 6 in Section 3 of document for corresponding number
- Resource Property**
- Study Area**
- Parks**
- Existing Right of Way**
- Alternative B Potential Impact Limits**
- Alternative C Potential Impact Limits**
- Alternative D Potential Impact Limits**
- Alternative E Potential Impact Limits**
- Alternative G Potential Impact Limits**
- Neighborhood Boundary**

U.S. Department of Transportation  
Federal Highway Administration



**COMMUNITY FACILITIES & RESOURCES  
(OHIO)**

**EXHIBIT  
11D**





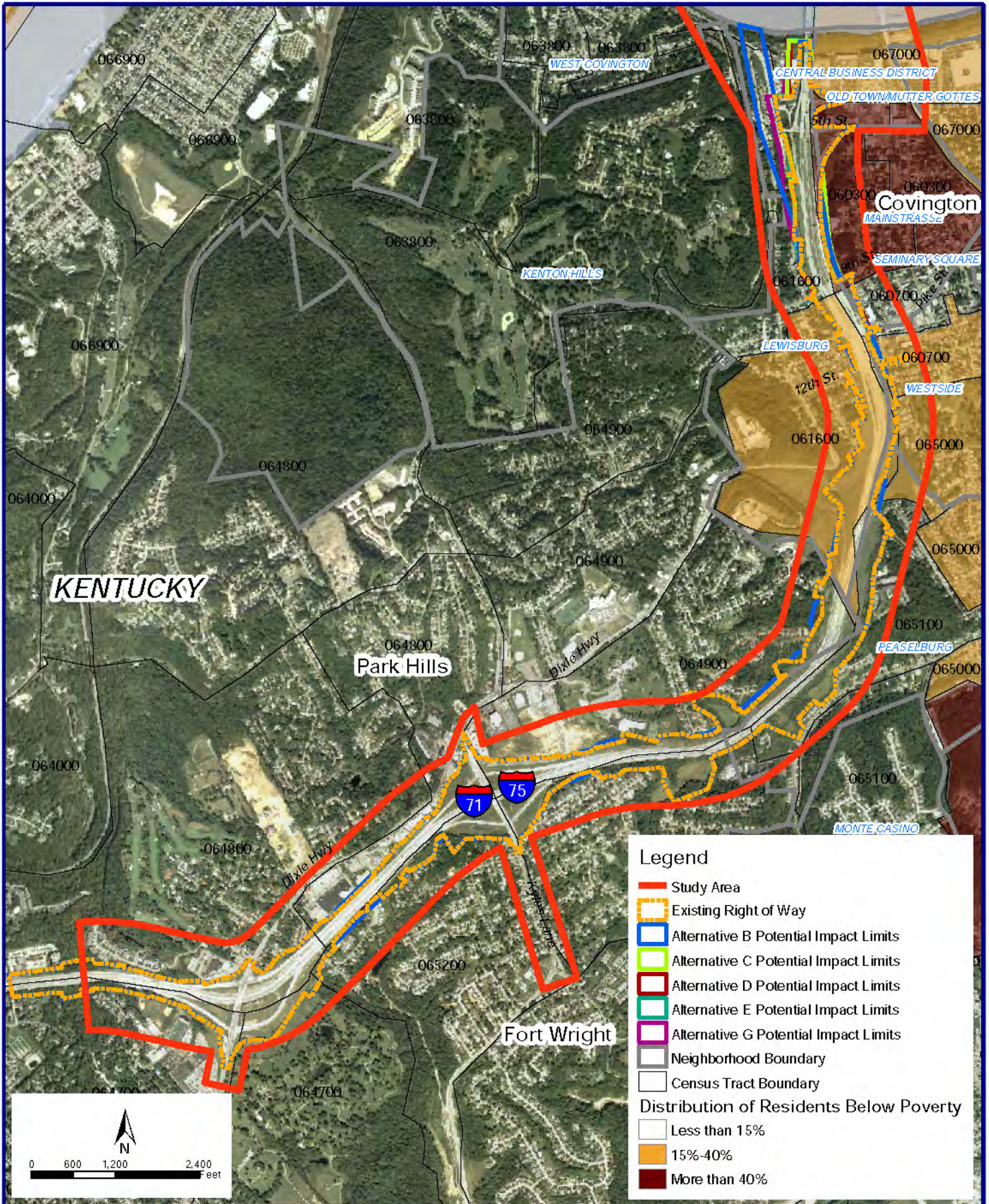

U.S. Department of Transportation  
Federal Highway Administration



POPULATIONS BELOW POVERTY  
(KENTUCKY)

EXHIBIT

12A

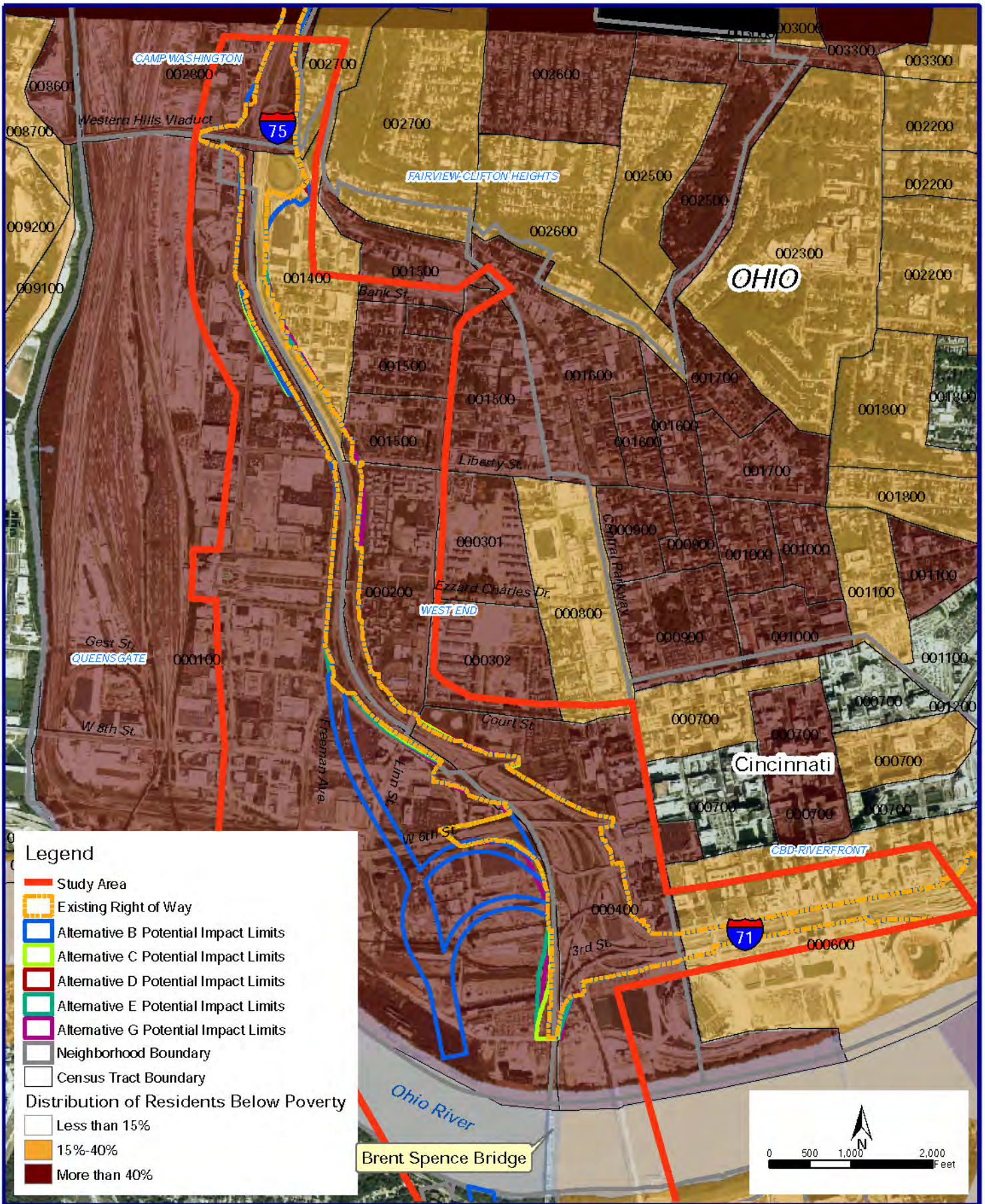

POPULATIONS BELOW POVERTY  
(OHIO)

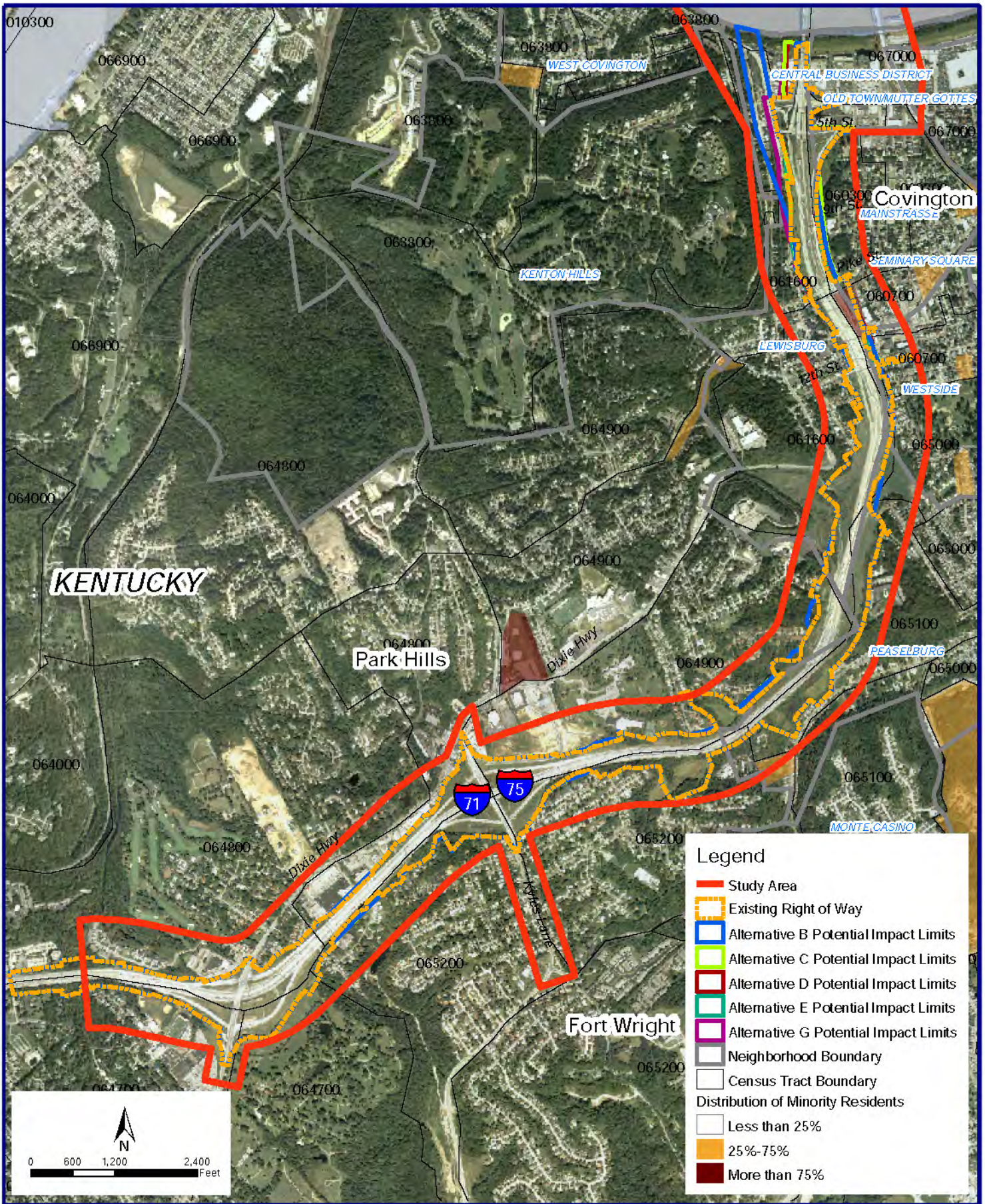

U.S. Department of Transportation  
Federal Highway Administration



## MINORITY POPULATIONS (KENTUCKY)

**EXHIBIT**  
12C

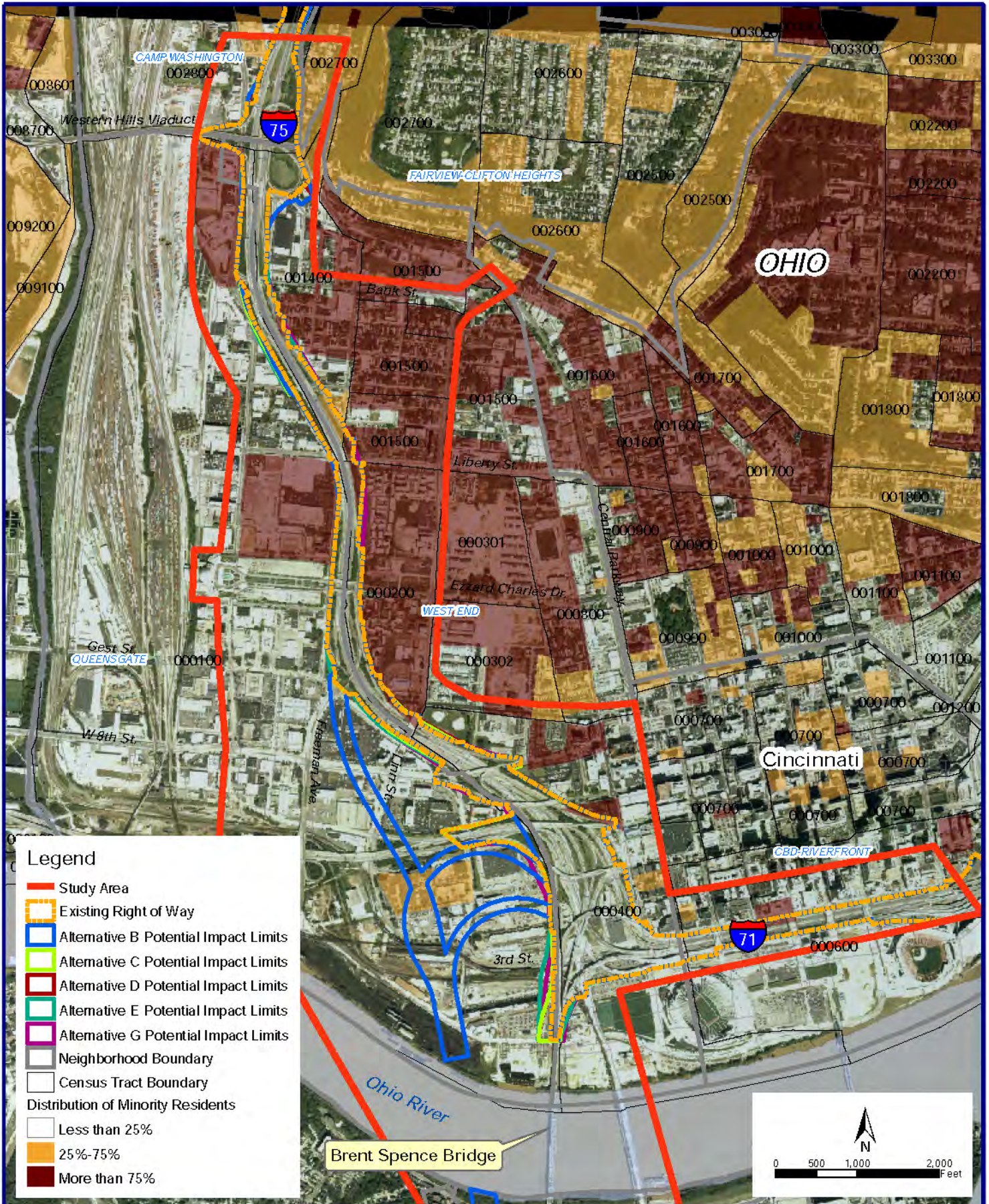

U.S. Department of Transportation  
Federal Highway Administration



MINORITY POPULATIONS  
(OHIO)

EXHIBIT

12D

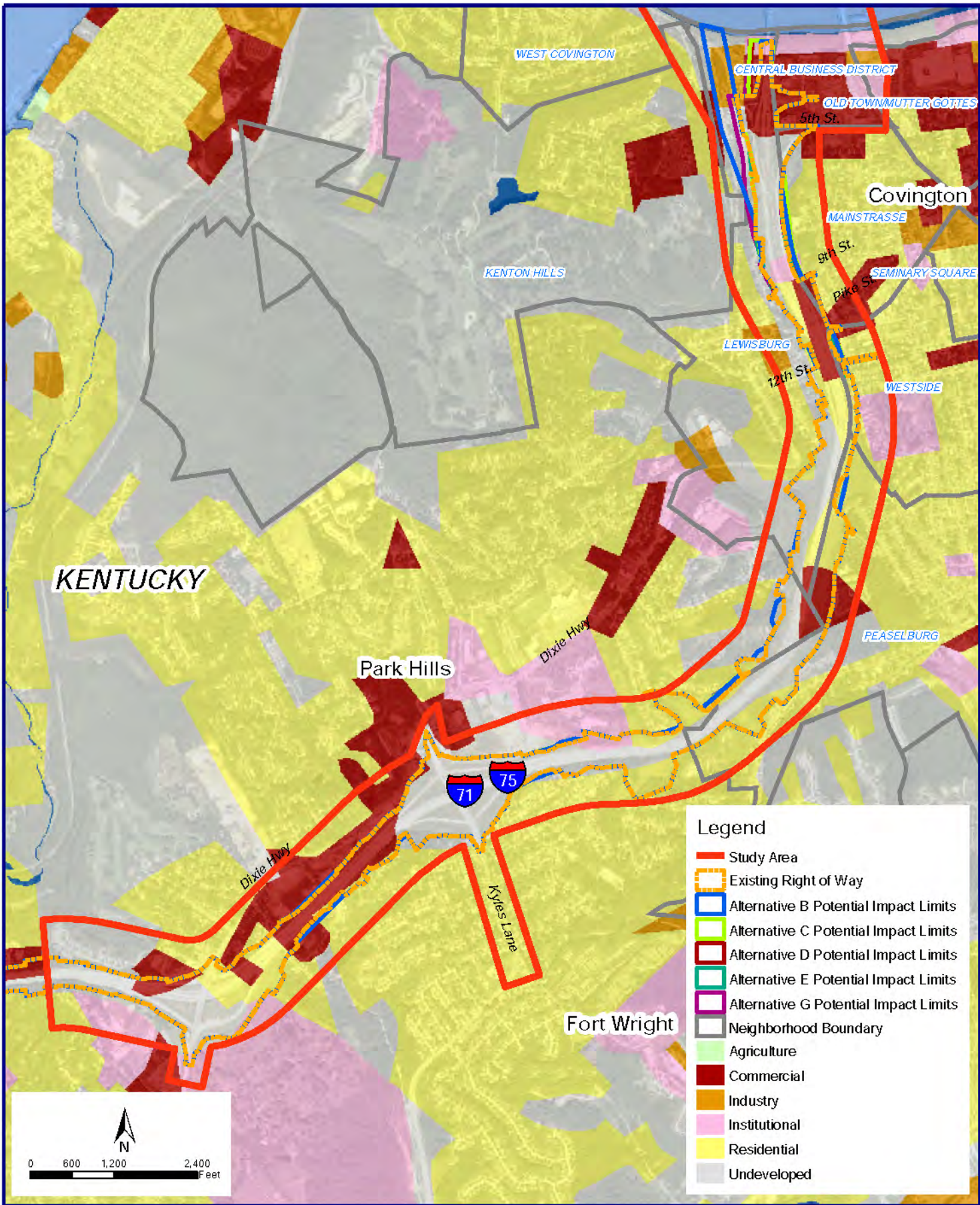

**Legend**

- Study Area
- Existing Right of Way
- Alternative B Potential Impact Limits
- Alternative C Potential Impact Limits
- Alternative D Potential Impact Limits
- Alternative E Potential Impact Limits
- Alternative G Potential Impact Limits
- Neighborhood Boundary
- Agriculture
- Commercial
- Industry
- Institutional
- Residential
- Undeveloped

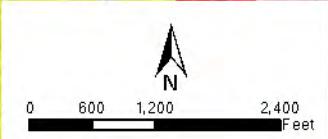



U.S. Department of Transportation  
Federal Highway Administration



EXISTING LAND USE (OHIO)

EXHIBIT

13B

Legend

- Study Area
- Existing Right of Way
- Alternative B Potential Impact Limits
- Alternative C Potential Impact Limits
- Alternative D Potential Impact Limits
- Alternative E Potential Impact Limits
- Alternative G Potential Impact Limits
- Interstates
- Soil and Geologic Hazard Area
- Alluvial land
- Chagrin gravelly silty clay loam
- Eden silty clay loam
- Faywood silty clay
- Faywood silty clay loam
- Huntington silt loam
- Negley silt loam
- Pate-Urban land complex
- Rossmoyne silt loam
- Urban land
- Urban land-Elkinsville complex
- Urban land-Huntington complex
- Urban land-Martinsville complex
- Urban land-Stonelick complex
- Water

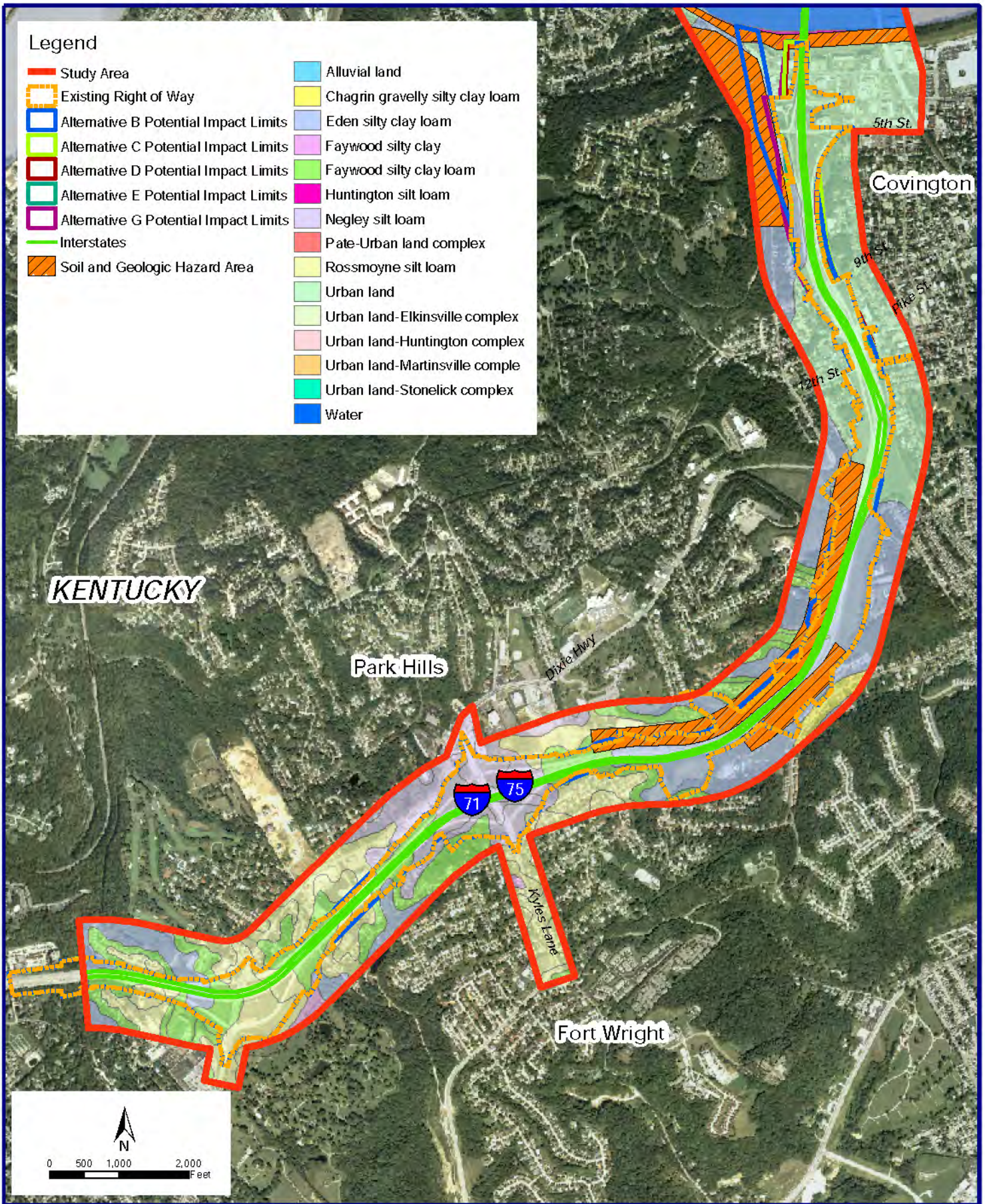

KENTUCKY

Park Hills

Dixie Hwy

71 75

Kyle Lane

Fort Wright

Covington

5th St

9th St

Pike St

12th St

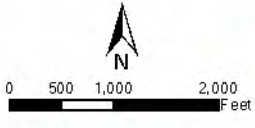

SOIL AND GEOLOGIC HAZARDS (KENTUCKY)

EXHIBIT 14A

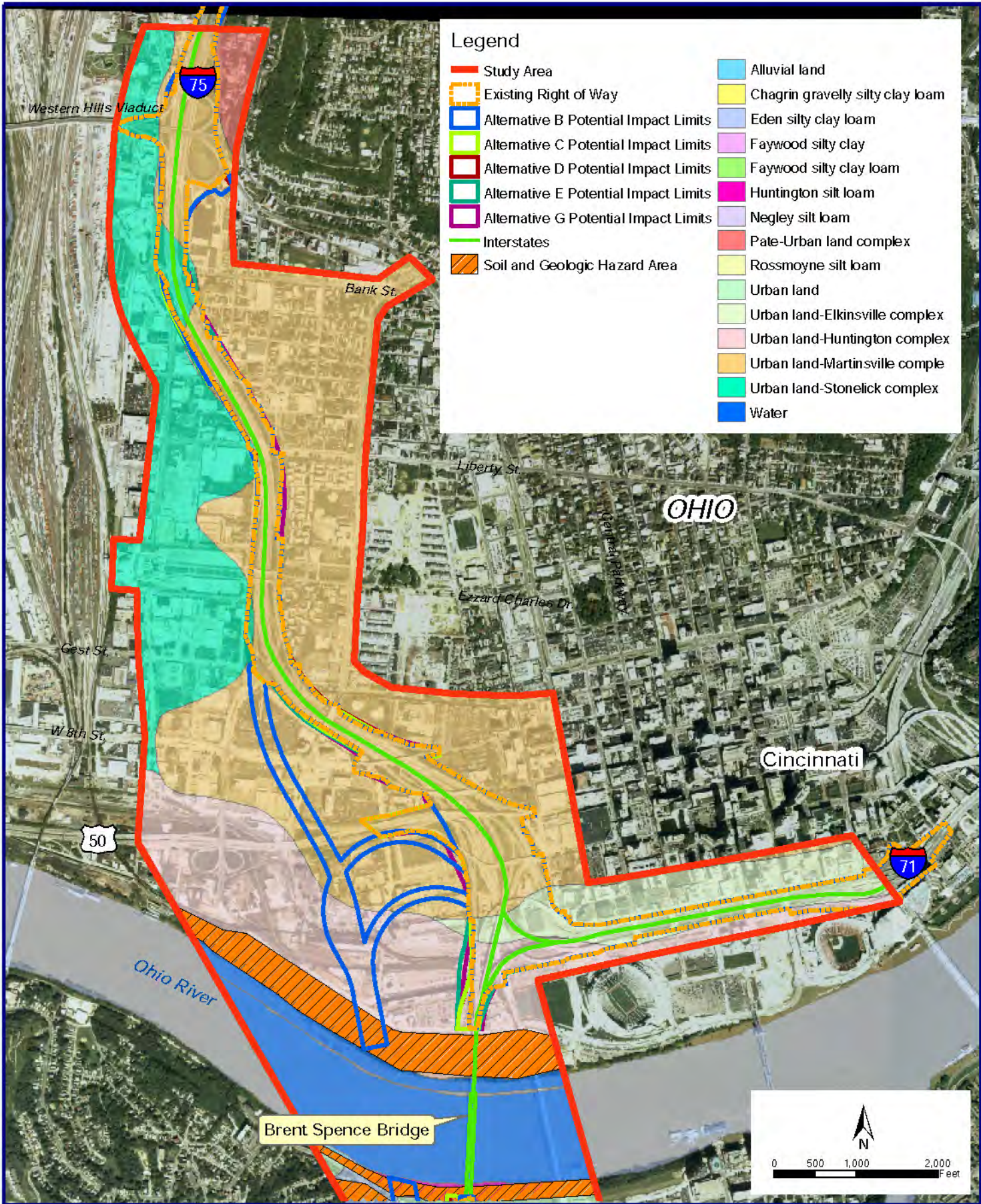

**Legend**

Study Area	Alluvial land
Existing Right of Way	Chagrin gravelly silty clay loam
Alternative B Potential Impact Limits	Eden silty clay loam
Alternative C Potential Impact Limits	Faywood silty clay
Alternative D Potential Impact Limits	Faywood silty clay loam
Alternative E Potential Impact Limits	Huntington silt loam
Alternative G Potential Impact Limits	Negley silt loam
Interstates	Pate-Urban land complex
Soil and Geologic Hazard Area	Rossmoyne silt loam
	Urban land
	Urban land-Elkinsville complex
	Urban land-Huntington complex
	Urban land-Martinsville complex
	Urban land-Stonelick complex
	Water

U.S. Department of Transportation  
Federal Highway Administration



SOIL AND GEOLOGIC HAZARDS  
(OHIO)

**EXHIBIT**  
14B



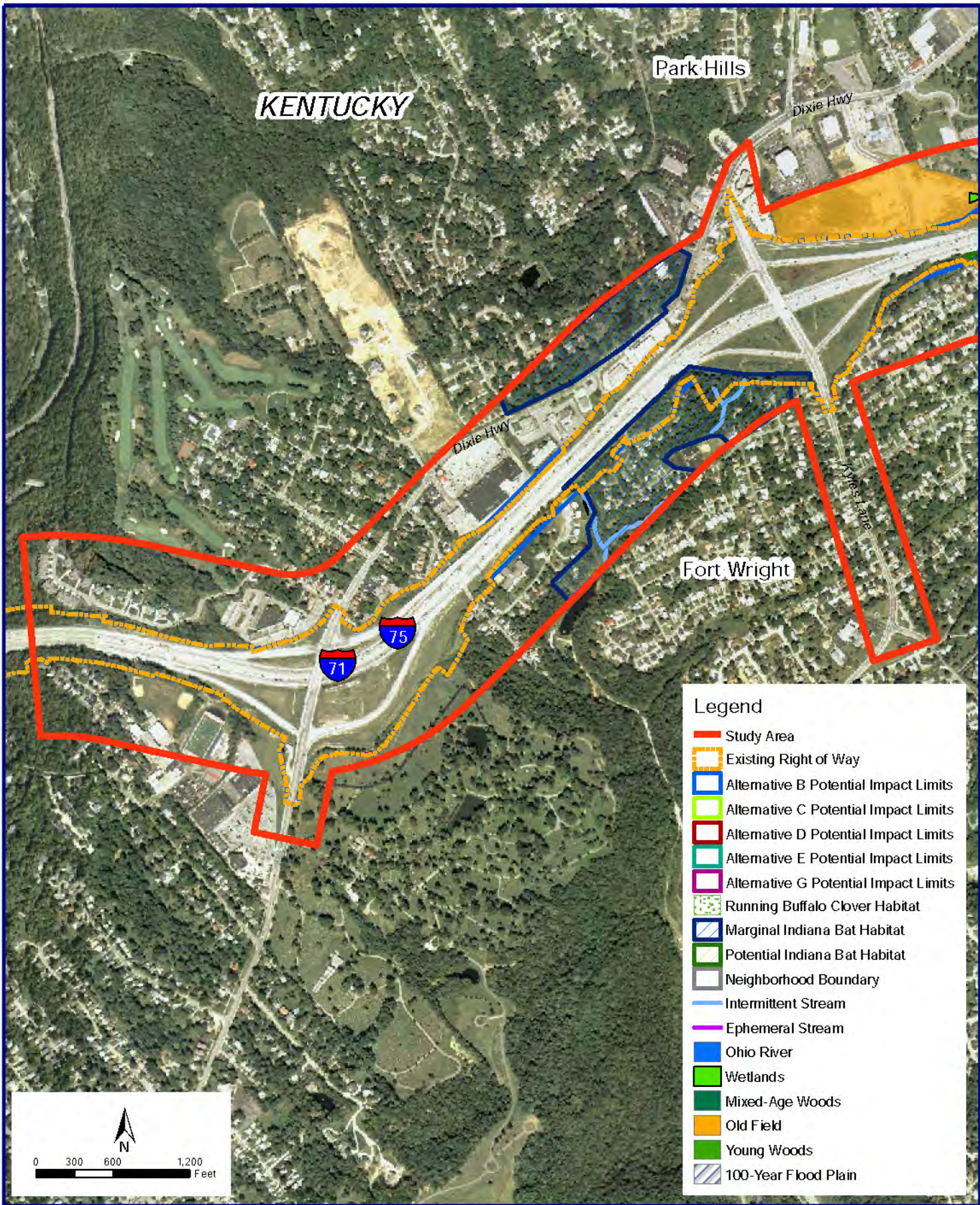

**KENTUCKY**

Park Hills

Dixie Hwy

Dixie Hwy

KY 137

Fort Wright

71 75

**Legend**

- Study Area
- Existing Right of Way
- Alternative B Potential Impact Limits
- Alternative C Potential Impact Limits
- Alternative D Potential Impact Limits
- Alternative E Potential Impact Limits
- Alternative G Potential Impact Limits
- Running Buffalo Clover Habitat
- Marginal Indiana Bat Habitat
- Potential Indiana Bat Habitat
- Neighborhood Boundary
- Intermittent Stream
- Ephemeral Stream
- Ohio River
- Wetlands
- Mixed-Age Woods
- Old Field
- Young Woods
- 100-Year Flood Plain

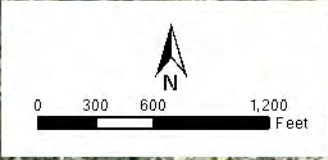

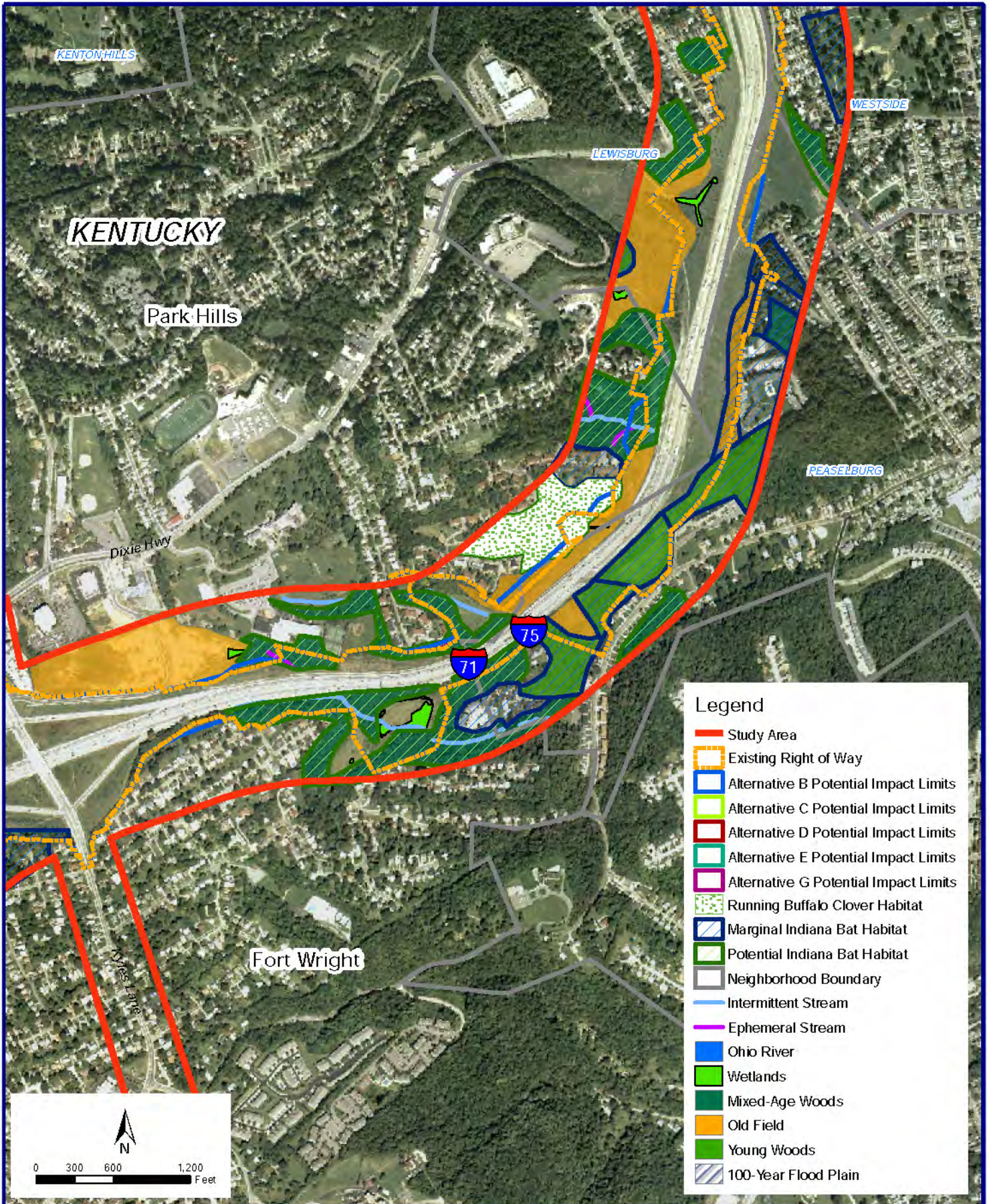

**Legend**

- Study Area
- Existing Right of Way
- Alternative B Potential Impact Limits
- Alternative C Potential Impact Limits
- Alternative D Potential Impact Limits
- Alternative E Potential Impact Limits
- Alternative G Potential Impact Limits
- Running Buffalo Clover Habitat
- Marginal Indiana Bat Habitat
- Potential Indiana Bat Habitat
- Neighborhood Boundary
- Intermittent Stream
- Ephemeral Stream
- Ohio River
- Wetlands
- Mixed-Age Woods
- Old Field
- Young Woods
- 100-Year Flood Plain

U.S. Department of Transportation  
Federal Highway Administration



**ECOLOGICAL RESOURCES  
(KENTUCKY)**

**EXHIBIT**

15B

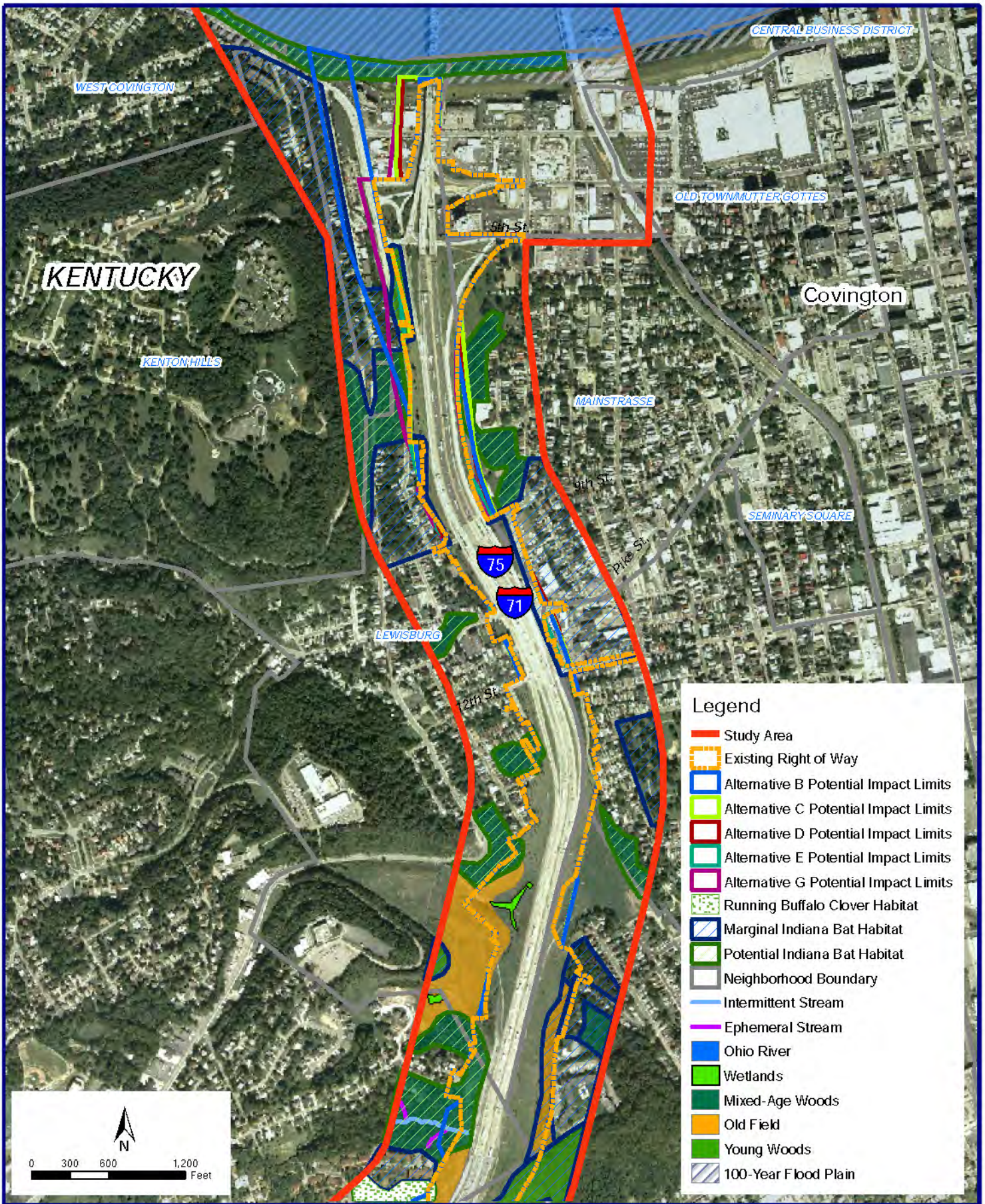

- Legend**
- Study Area
  - Existing Right of Way
  - Alternative B Potential Impact Limits
  - Alternative C Potential Impact Limits
  - Alternative D Potential Impact Limits
  - Alternative E Potential Impact Limits
  - Alternative G Potential Impact Limits
  - Running Buffalo Clover Habitat
  - Marginal Indiana Bat Habitat
  - Potential Indiana Bat Habitat
  - Neighborhood Boundary
  - Intermittent Stream
  - Ephemeral Stream
  - Ohio River
  - Wetlands
  - Mixed-Age Woods
  - Old Field
  - Young Woods
  - 100-Year Flood Plain

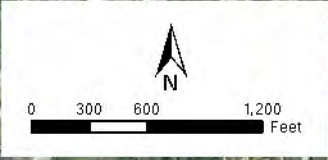

**ECOLOGICAL RESOURCES  
(KENTUCKY)**

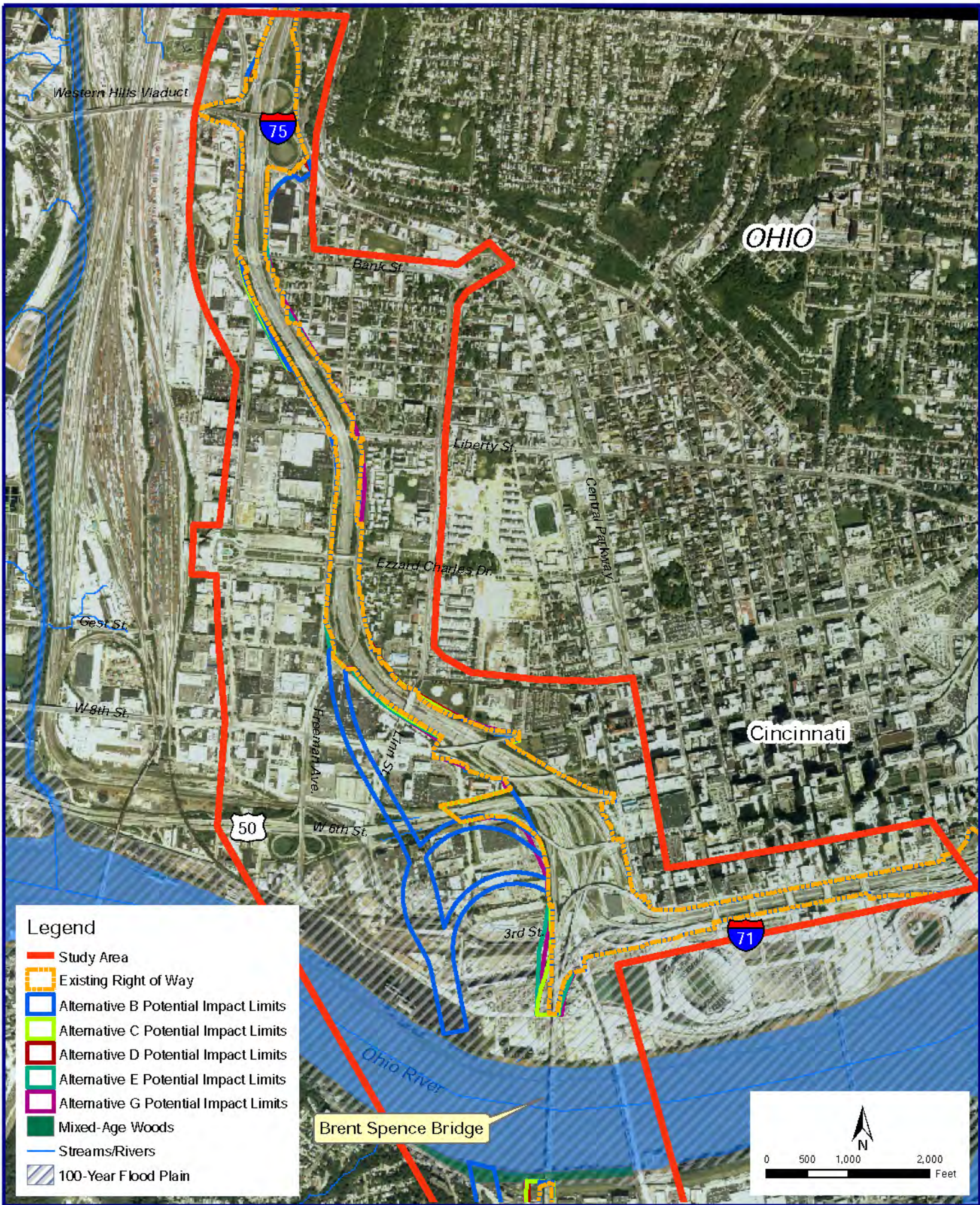

**Legend**

- Study Area
- Existing Right of Way
- Alternative B Potential Impact Limits
- Alternative C Potential Impact Limits
- Alternative D Potential Impact Limits
- Alternative E Potential Impact Limits
- Alternative G Potential Impact Limits
- Mixed-Age Woods
- Streams/Rivers
- 100-Year Flood Plain

N

0 500 1,000 2,000  
Feet

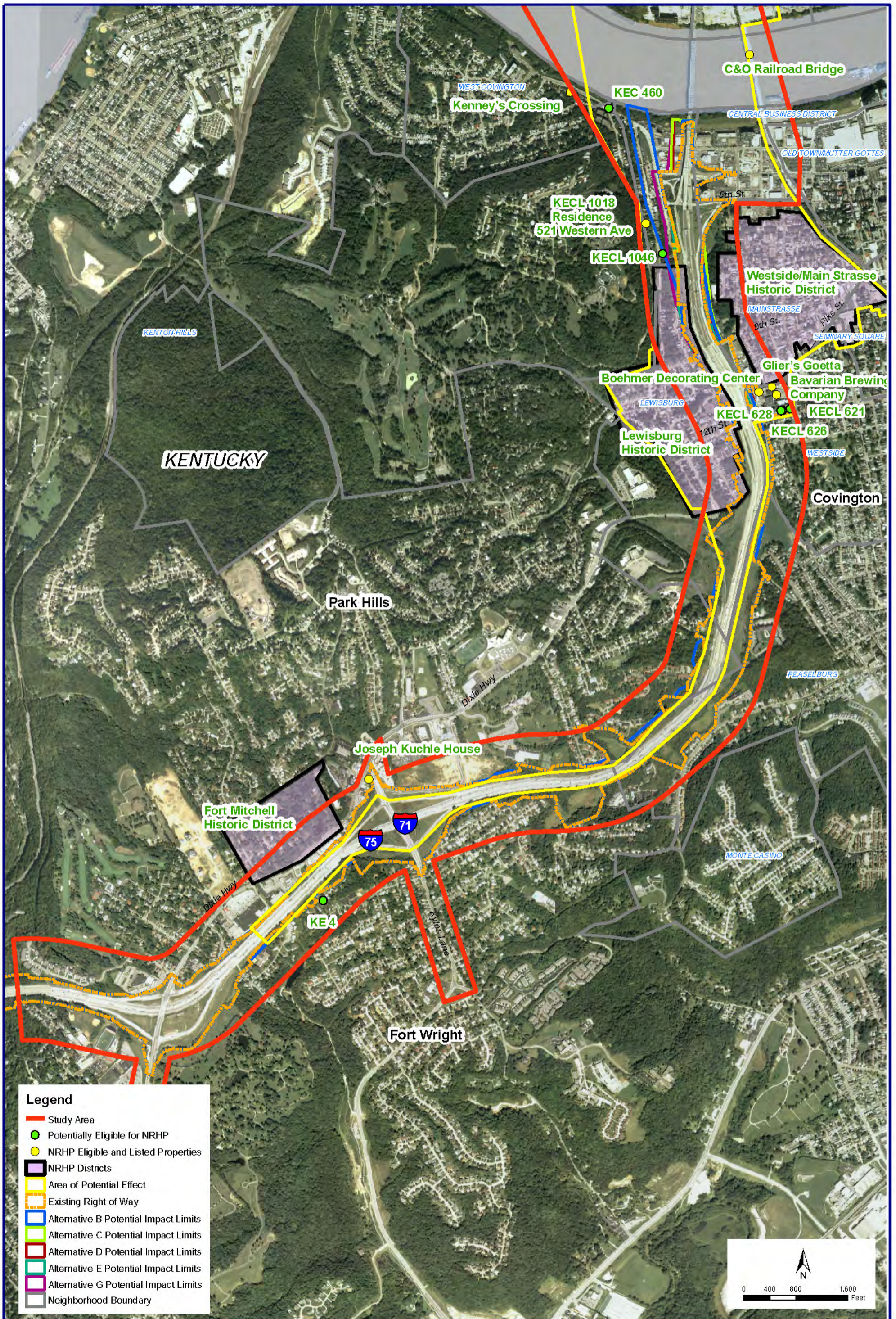

**Legend**

- Study Area
- Potentially Eligible for NRHP
- NRHP Eligible and Listed Properties
- NRHP Districts
- Area of Potential Effect
- Existing Right of Way
- Alternative B Potential Impact Limits
- Alternative C Potential Impact Limits
- Alternative D Potential Impact Limits
- Alternative E Potential Impact Limits
- Alternative G Potential Impact Limits
- Neighborhood Boundary



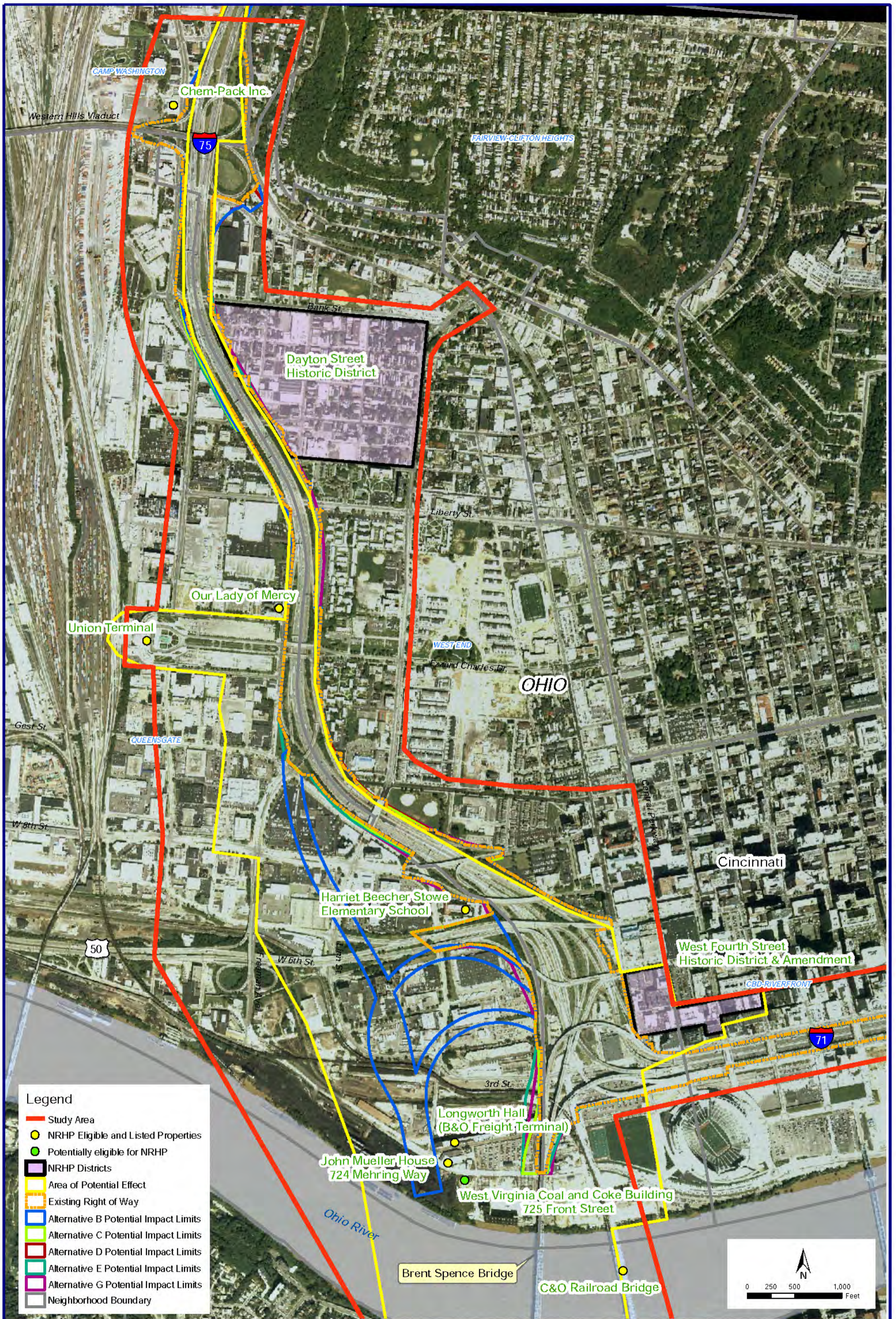

**Legend**

- Study Area
- NRHP Eligible and Listed Properties
- Potentially eligible for NRHP
- NRHP Districts
- Area of Potential Effect
- Existing Right of Way
- Alternative B Potential Impact Limits
- Alternative C Potential Impact Limits
- Alternative D Potential Impact Limits
- Alternative E Potential Impact Limits
- Alternative G Potential Impact Limits
- Neighborhood Boundary

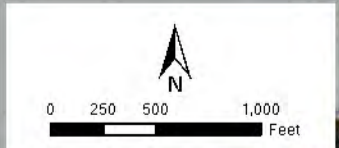

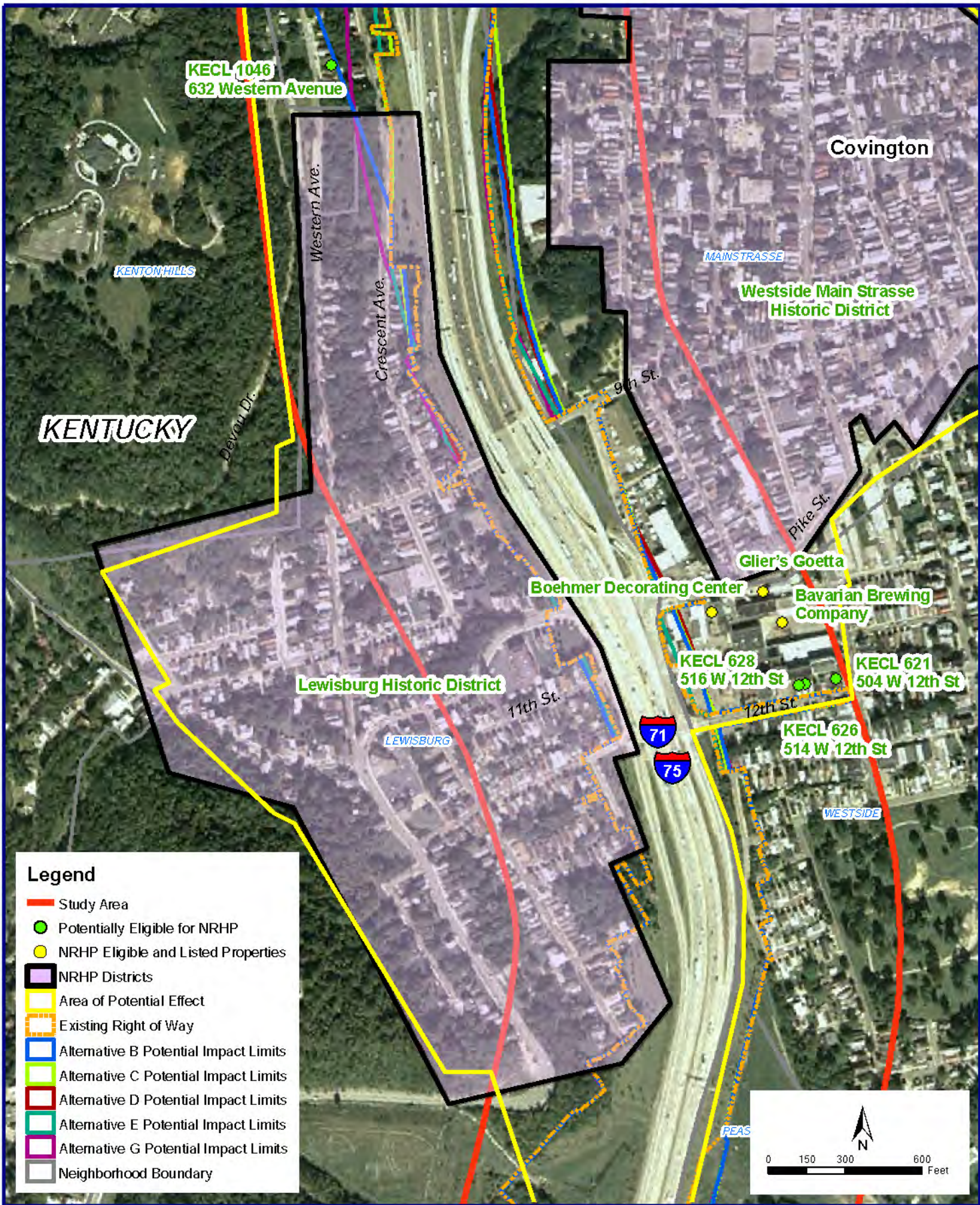

**Legend**

- Study Area
- Potentially Eligible for NRHP
- NRHP Eligible and Listed Properties
- NRHP Districts
- Area of Potential Effect
- Existing Right of Way
- Alternative B Potential Impact Limits
- Alternative C Potential Impact Limits
- Alternative D Potential Impact Limits
- Alternative E Potential Impact Limits
- Alternative G Potential Impact Limits
- Neighborhood Boundary



U.S. Department of Transportation  
Federal Highway Administration



**CULTURAL RESOURCES (KENTUCKY)**

**EXHIBIT  
16C**

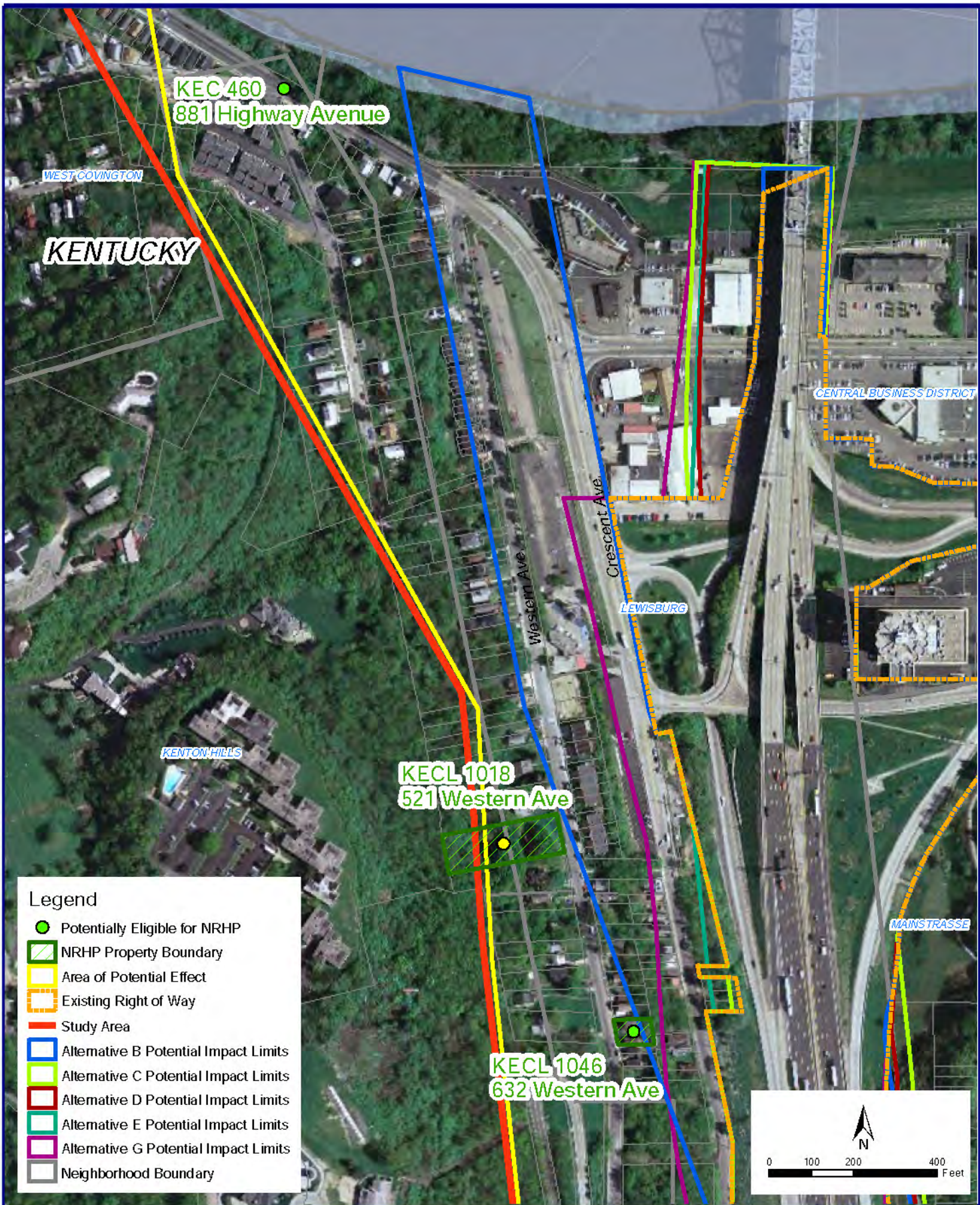

**Legend**

- Potentially Eligible for NRHP
- NRHP Property Boundary
- Area of Potential Effect
- Existing Right of Way
- Study Area
- Alternative B Potential Impact Limits
- Alternative C Potential Impact Limits
- Alternative D Potential Impact Limits
- Alternative E Potential Impact Limits
- Alternative G Potential Impact Limits
- Neighborhood Boundary

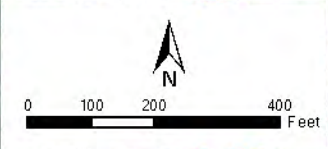

U.S. Department of Transportation  
Federal Highway Administration



**CULTURAL RESOURCES (KENTUCKY)**

**EXHIBIT**  
16D



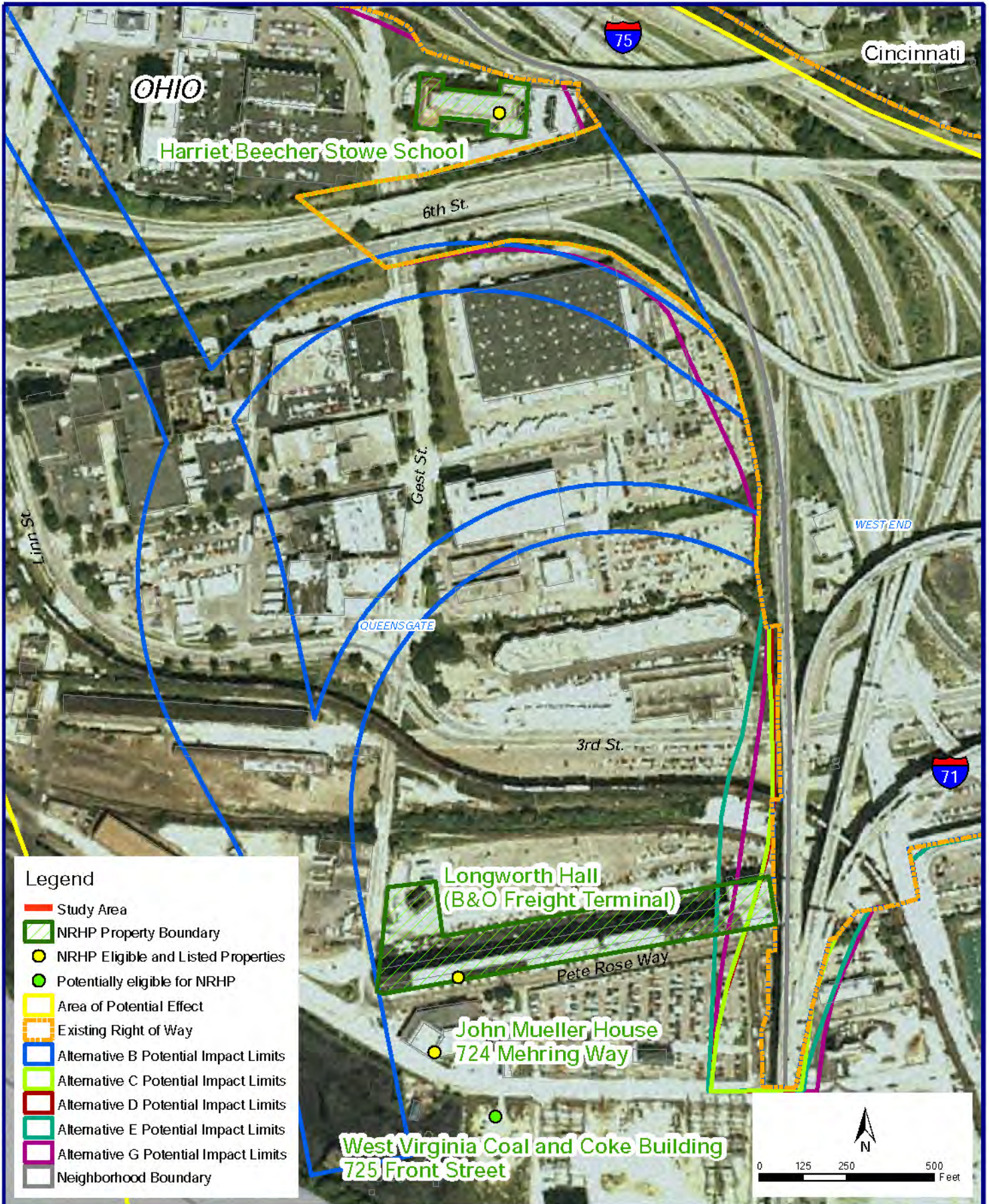

U.S. Department of Transportation  
Federal Highway Administration



CULTURAL RESOURCES (OHIO)

EXHIBIT

16E

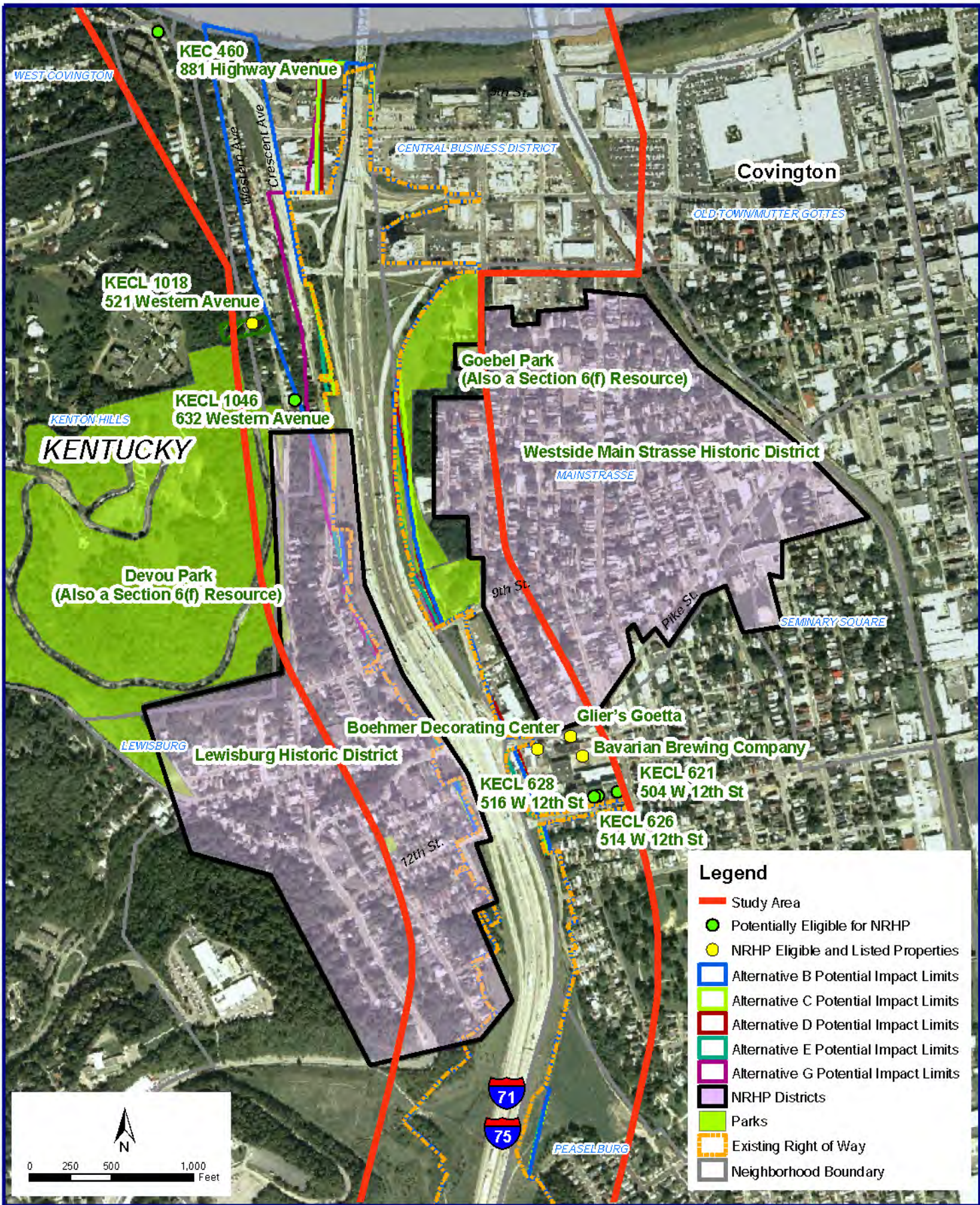

- Legend**
- Study Area
  - Potentially Eligible for NRHP
  - NRHP Eligible and Listed Properties
  - Alternative B Potential Impact Limits
  - Alternative C Potential Impact Limits
  - Alternative D Potential Impact Limits
  - Alternative E Potential Impact Limits
  - Alternative G Potential Impact Limits
  - NRHP Districts
  - Parks
  - Existing Right of Way
  - Neighborhood Boundary

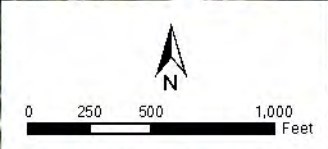

U.S. Department of Transportation  
Federal Highway Administration



**SECTION 4(f) RESOURCES (KENTUCKY)**

**EXHIBIT**  
**17A**

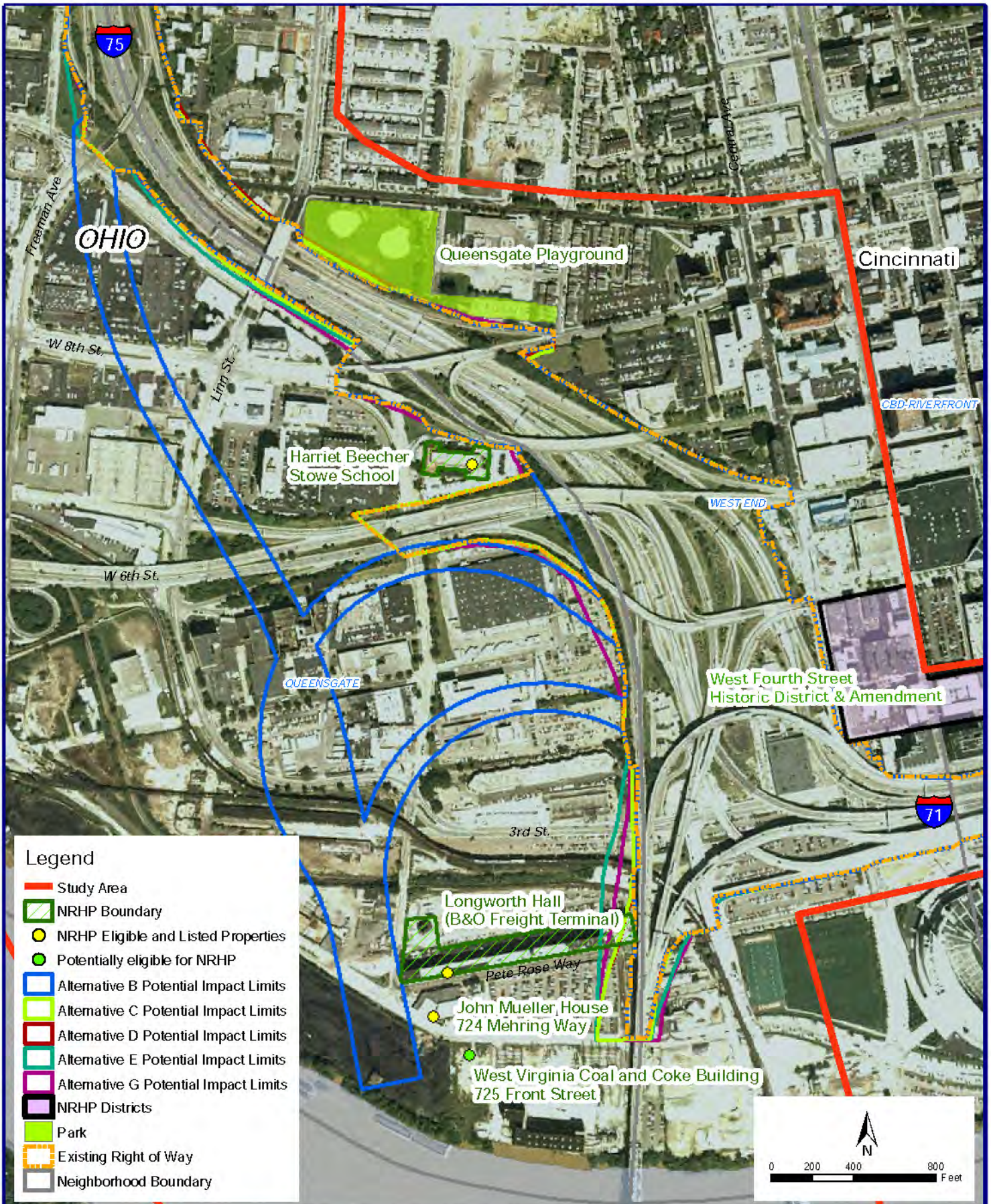

- Legend**
- Study Area
  - NRHP Boundary
  - NRHP Eligible and Listed Properties
  - Potentially eligible for NRHP
  - Alternative B Potential Impact Limits
  - Alternative C Potential Impact Limits
  - Alternative D Potential Impact Limits
  - Alternative E Potential Impact Limits
  - Alternative G Potential Impact Limits
  - NRHP Districts
  - Park
  - Existing Right of Way
  - Neighborhood Boundary

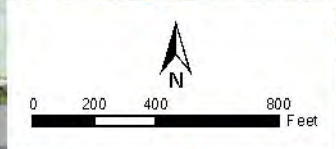

U.S. Department of Transportation  
Federal Highway Administration



SECTION 4(f) RESOURCES (OHIO)

**EXHIBIT**  
17B

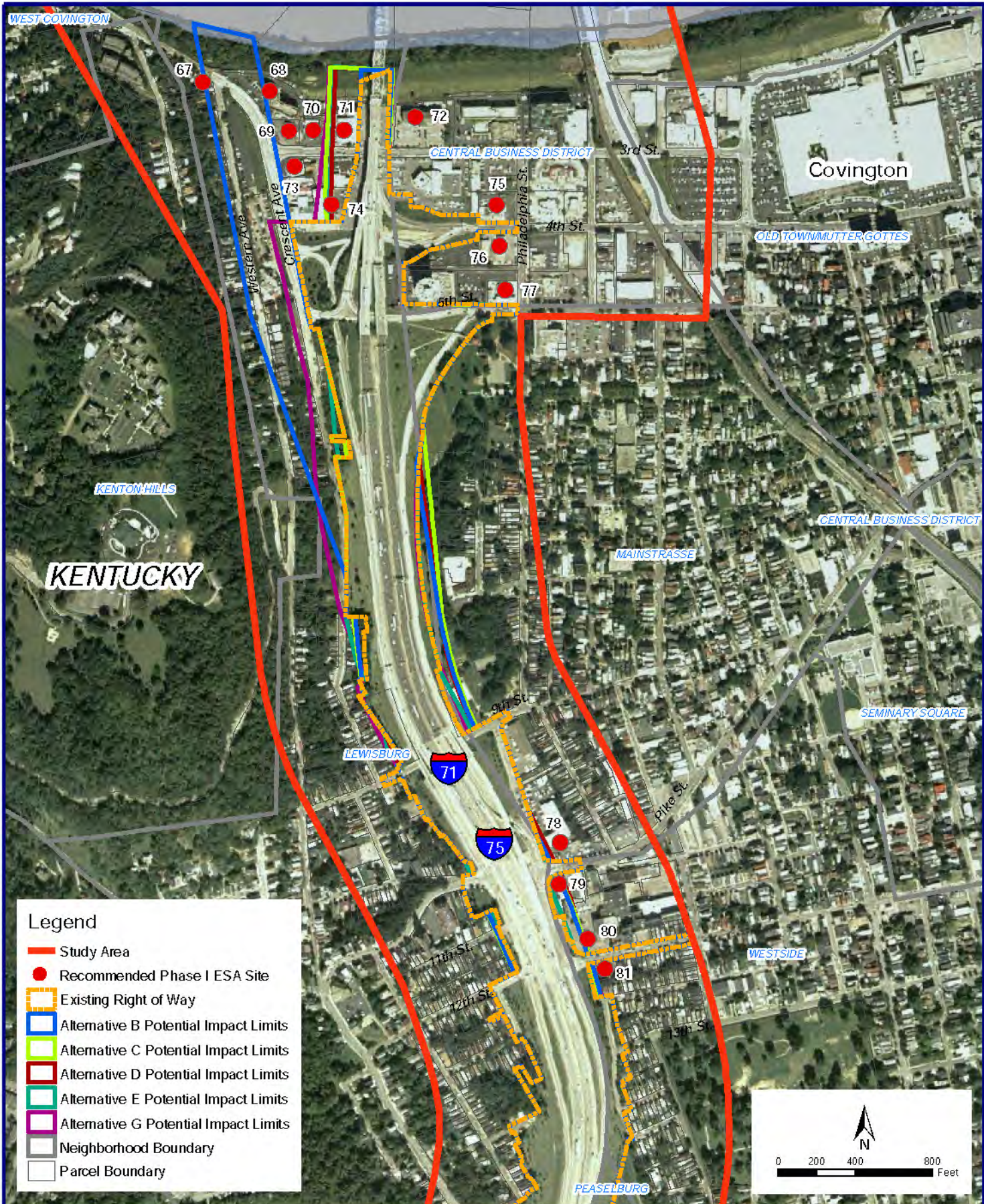

U.S. Department of Transportation  
Federal Highway Administration



RECOMMENDED PHASE I  
ENVIRONMENTAL SITE ASSESSMENT (ESA)  
LOCATIONS (KENTUCKY)

EXHIBIT

18A

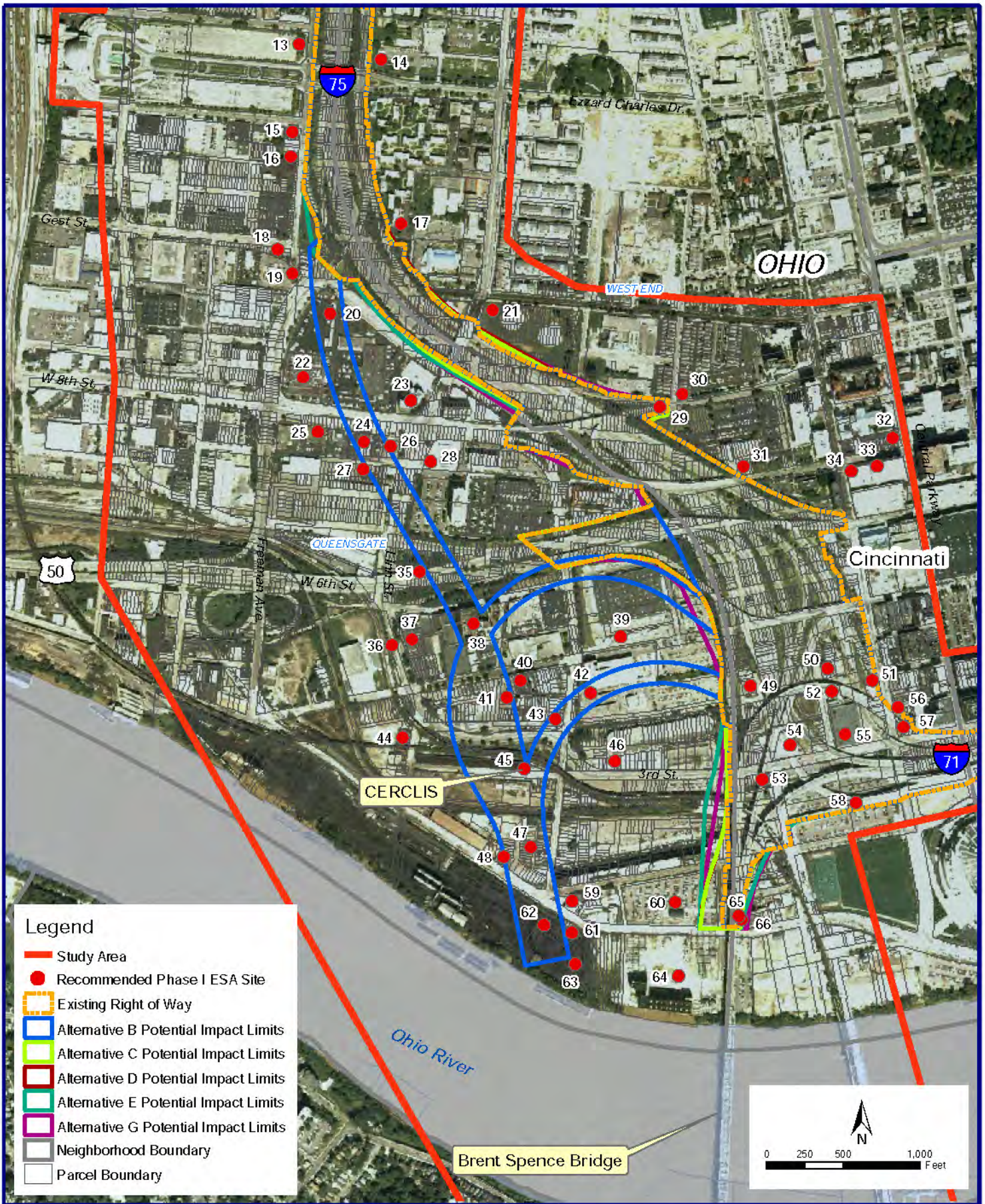

**Legend**

- Study Area
- Recommended Phase I ESA Site
- Existing Right of Way
- Alternative B Potential Impact Limits
- Alternative C Potential Impact Limits
- Alternative D Potential Impact Limits
- Alternative E Potential Impact Limits
- Alternative G Potential Impact Limits
- Neighborhood Boundary
- Parcel Boundary

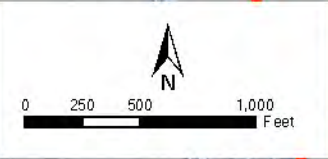

**RECOMMENDED PHASE I  
ENVIRONMENTAL SITE ASSESSMENT (ESA)  
LOCATIONS (OHIO)**

**EXHIBIT  
18B**

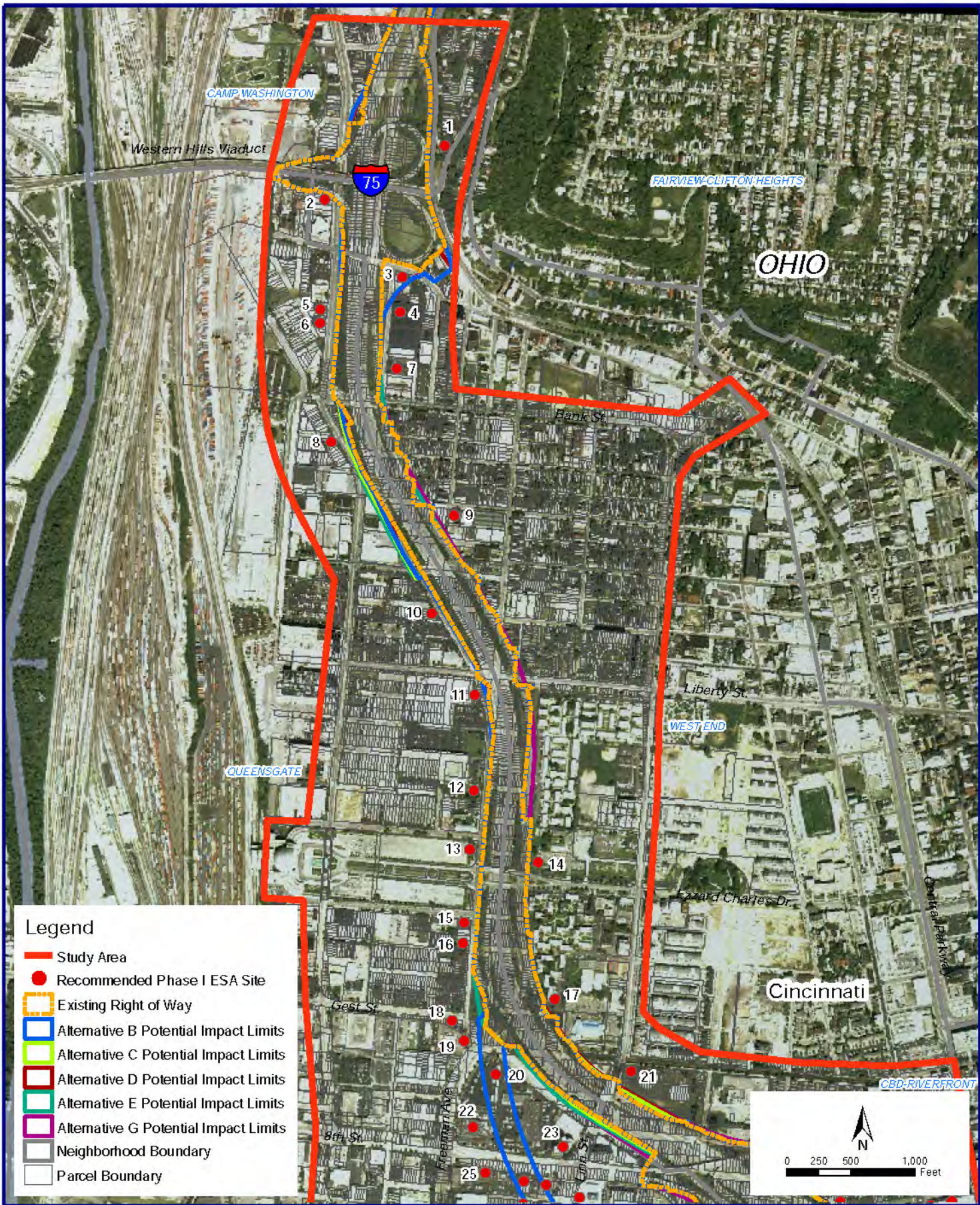

**Legend**

- Study Area
- Recommended Phase I ESA Site
- Existing Right of Way
- Alternative B Potential Impact Limits
- Alternative C Potential Impact Limits
- Alternative D Potential Impact Limits
- Alternative E Potential Impact Limits
- Alternative G Potential Impact Limits
- Neighborhood Boundary
- Parcel Boundary

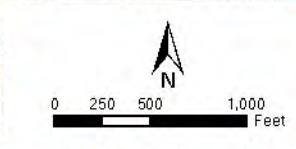

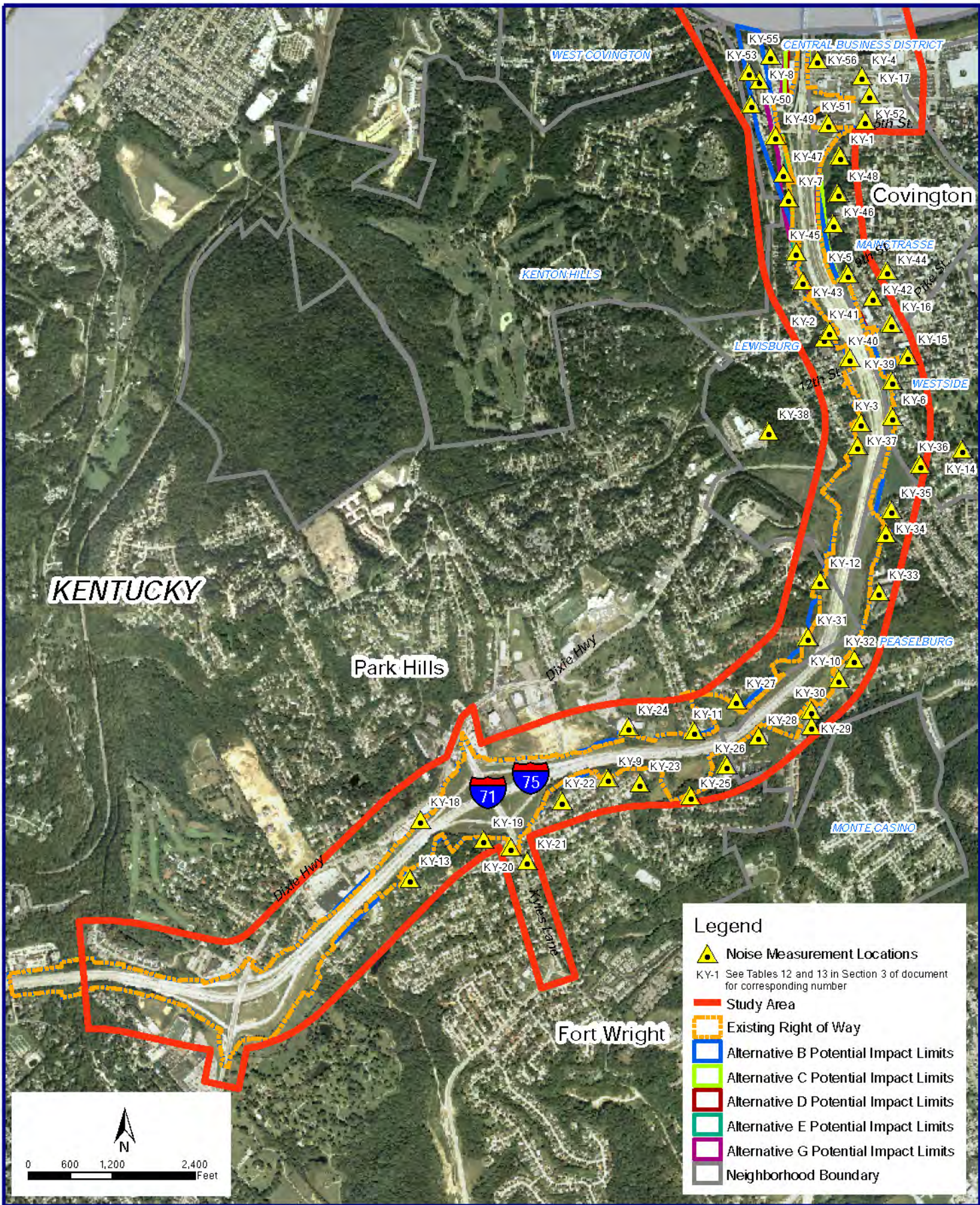

**Legend**

- Noise Measurement Locations  
KY-1 See Tables 12 and 13 in Section 3 of document for corresponding number
- Study Area
- Existing Right of Way
- Alternative B Potential Impact Limits
- Alternative C Potential Impact Limits
- Alternative D Potential Impact Limits
- Alternative E Potential Impact Limits
- Alternative G Potential Impact Limits
- Neighborhood Boundary

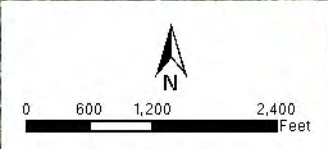

**NOISE MEASUREMENT LOCATIONS  
(KENTUCKY)**

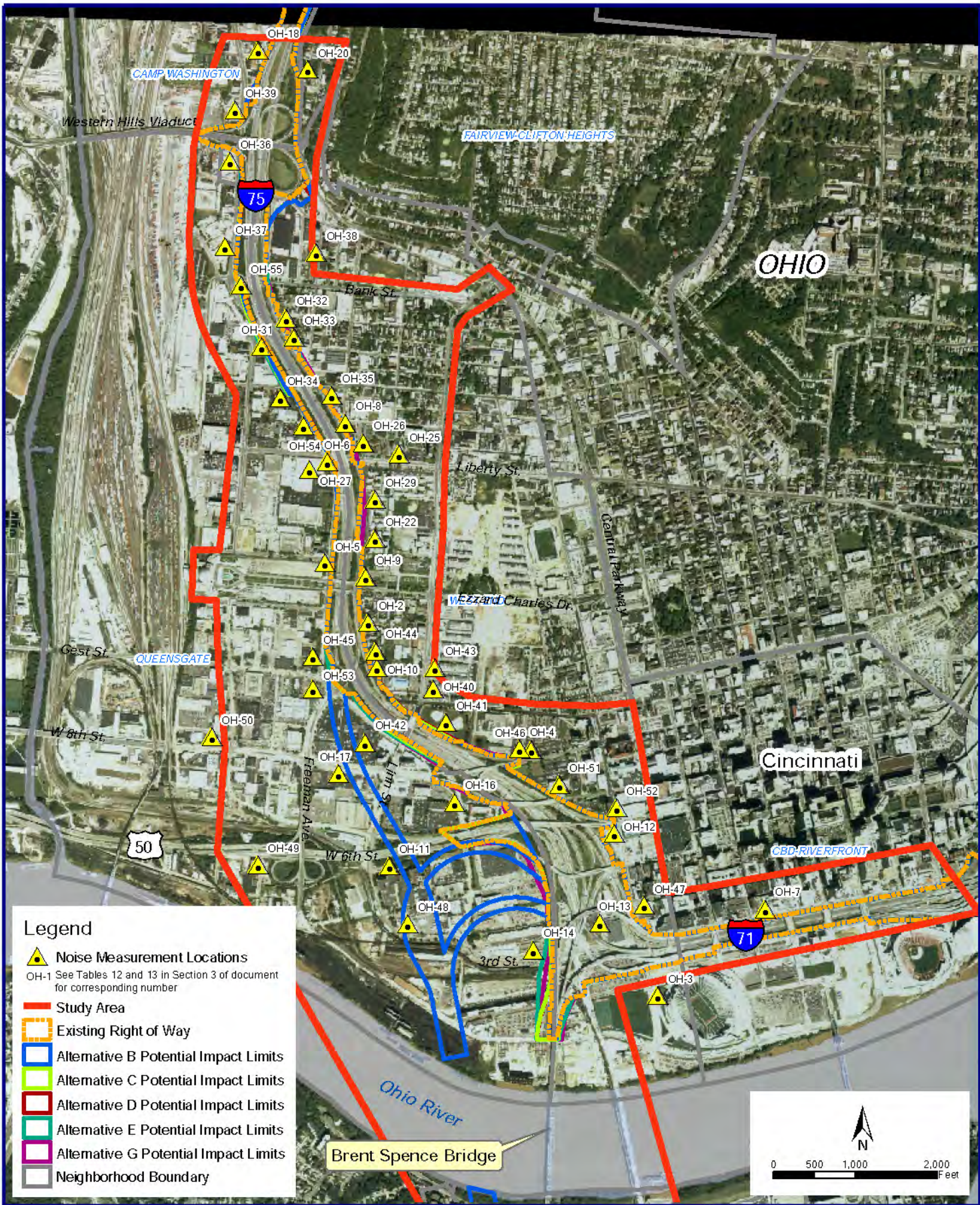

U.S. Department of Transportation  
Federal Highway Administration



## NOISE MEASUREMENT LOCATIONS (OHIO)

**EXHIBIT**  
19B



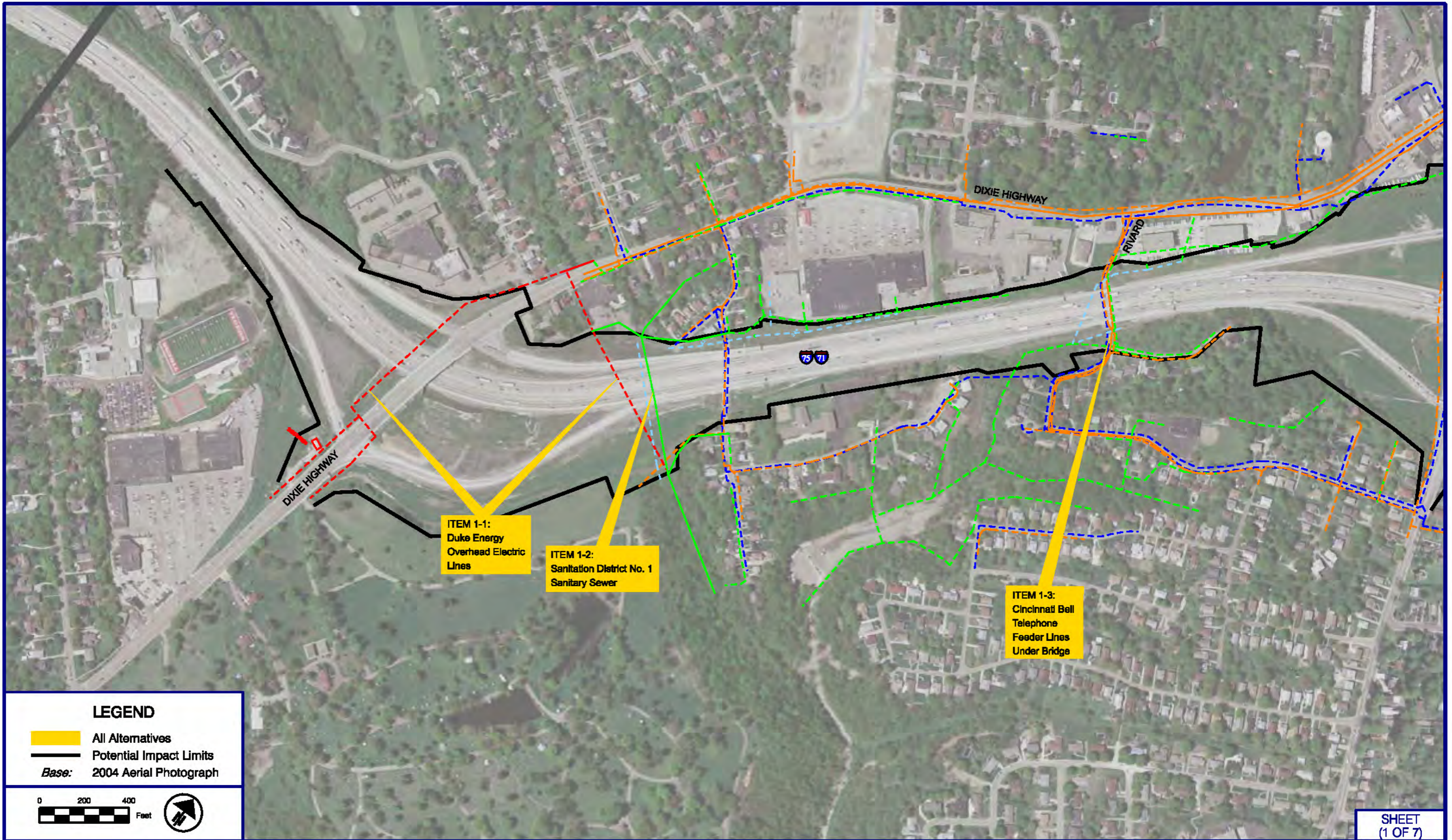

**LEGEND**

- All Alternatives
- Potential Impact Limits
- Base:* 2004 Aerial Photograph



ITEM 1-1:  
Duke Energy  
Overhead Electric  
Lines

ITEM 1-2:  
Sanitation District No. 1  
Sanitary Sewer

ITEM 1-3:  
Cincinnati Bell  
Telephone  
Feeder Lines  
Under Bridge

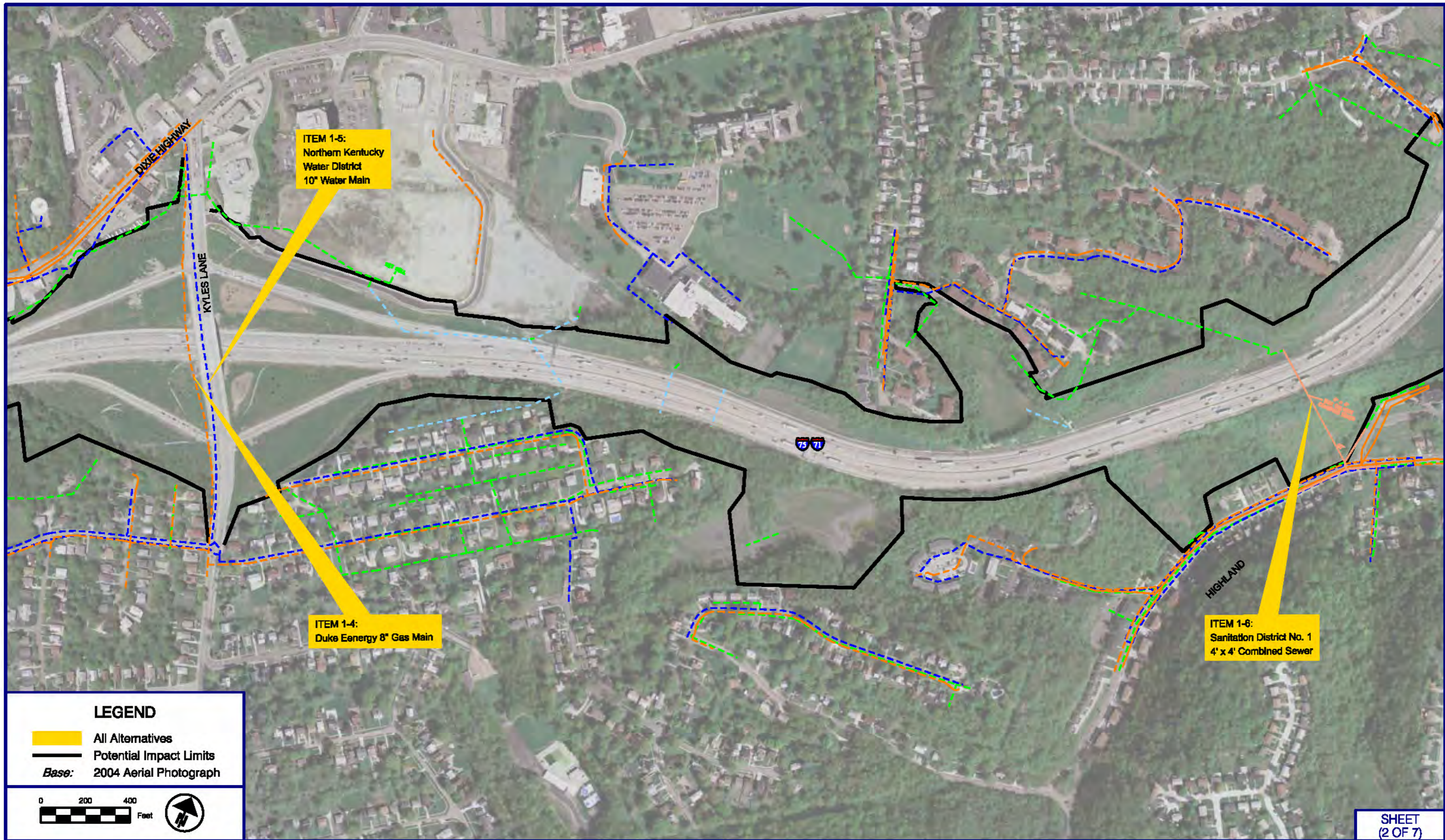

**LEGEND**

- All Alternatives
- Potential Impact Limits
- Base:* 2004 Aerial Photograph

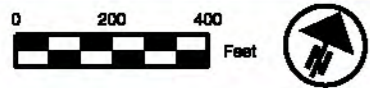

U.S. Department of Transportation  
Federal Highway Administration



Prepared by  
**PARSONS BRINCKERHOFF**

**POTENTIAL  
UTILITY IMPACTS**

SHEET  
(2 OF 7)

EXHIBIT  
20B

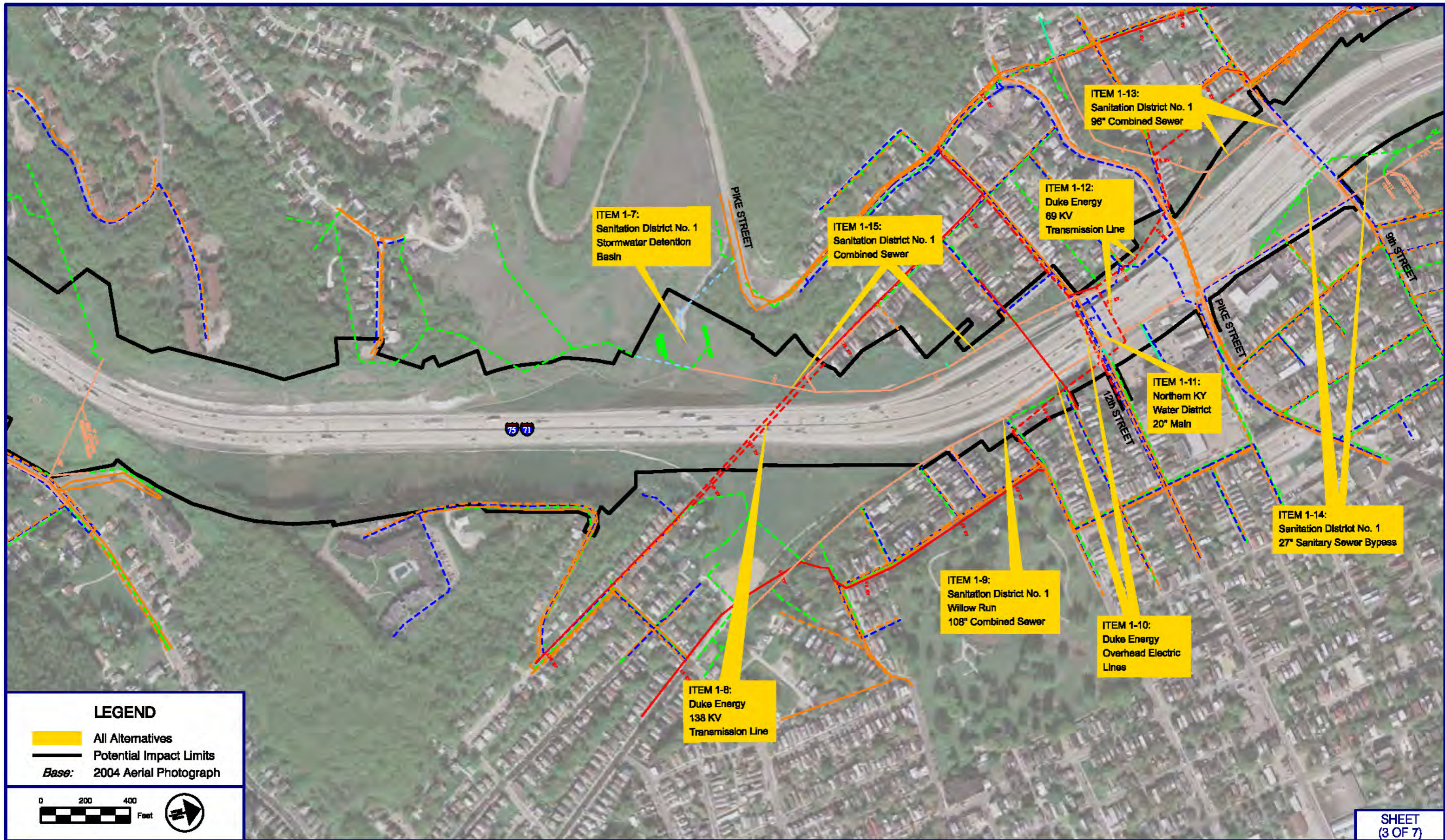

**LEGEND**

- All Alternatives
- Potential Impact Limits
- Base:* 2004 Aerial Photograph

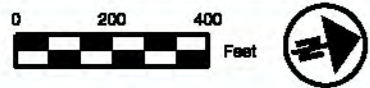

U.S. Department of Transportation  
Federal Highway Administration



Prepared by  
**PARSONS BRINCKERHOFF**

**POTENTIAL  
UTILITY IMPACTS**

SHEET  
(3 OF 7)

EXHIBIT  
20C

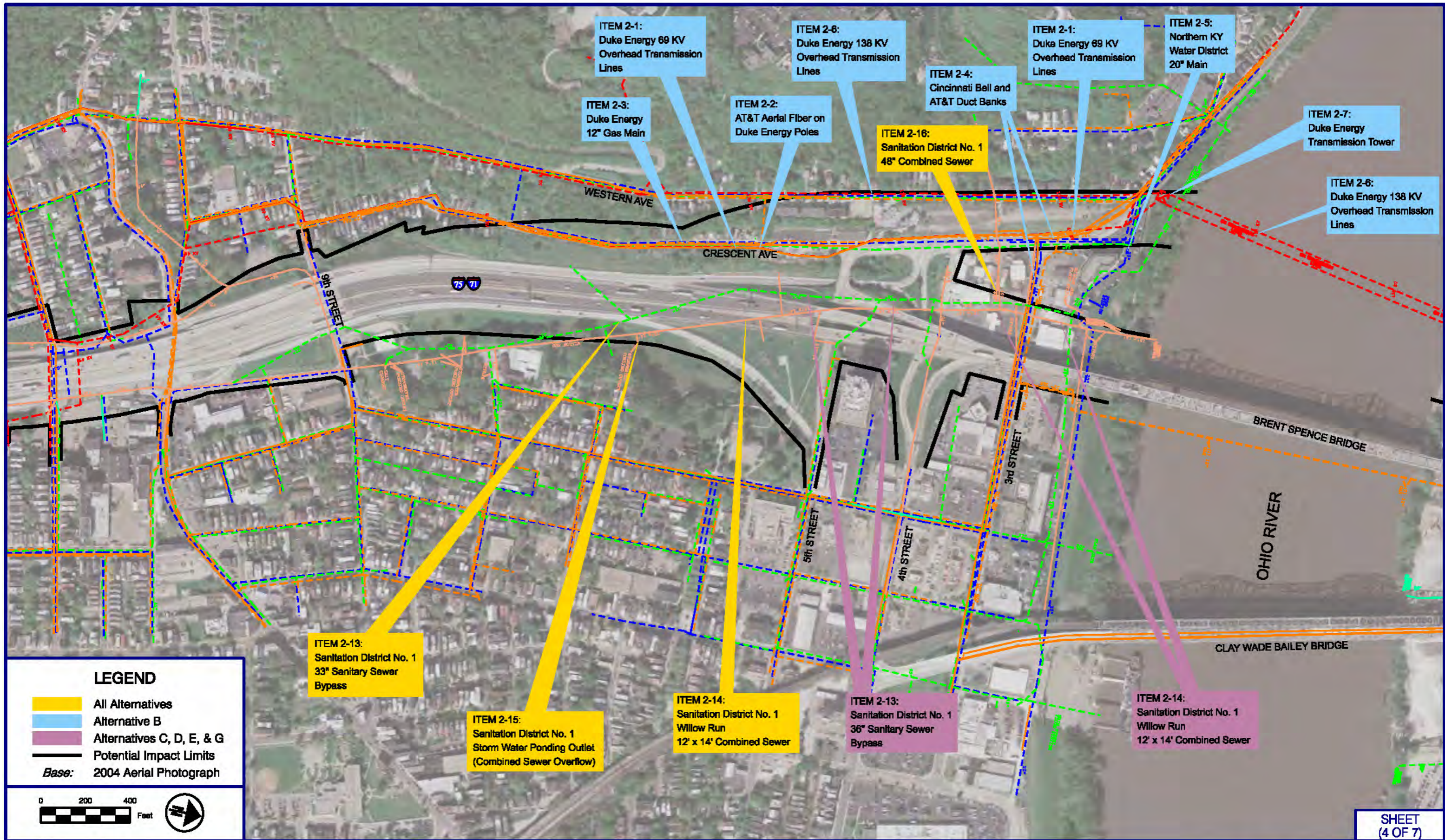

ITEM 2-1:  
Duke Energy 69 KV  
Overhead Transmission  
Lines

ITEM 2-6:  
Duke Energy 138 KV  
Overhead Transmission  
Lines

ITEM 2-1:  
Duke Energy 69 KV  
Overhead Transmission  
Lines

ITEM 2-5:  
Northern KY  
Water District  
20" Main

ITEM 2-3:  
Duke Energy  
12" Gas Main

ITEM 2-2:  
AT&T Aerial Fiber on  
Duke Energy Poles

ITEM 2-4:  
Cincinnati Bell and  
AT&T Duct Banks

ITEM 2-16:  
Sanitation District No. 1  
48" Combined Sewer

ITEM 2-7:  
Duke Energy  
Transmission Tower

ITEM 2-6:  
Duke Energy 138 KV  
Overhead Transmission  
Lines

ITEM 2-13:  
Sanitation District No. 1  
33" Sanitary Sewer  
Bypass

ITEM 2-15:  
Sanitation District No. 1  
Storm Water Ponding Outlet  
(Combined Sewer Overflow)

ITEM 2-14:  
Sanitation District No. 1  
Willow Run  
12' x 14' Combined Sewer

ITEM 2-13:  
Sanitation District No. 1  
36" Sanitary Sewer  
Bypass

ITEM 2-14:  
Sanitation District No. 1  
Willow Run  
12' x 14' Combined Sewer

**LEGEND**

- All Alternatives
  - Alternative B
  - Alternatives C, D, E, & G
  - Potential Impact Limits
- Base: 2004 Aerial Photograph

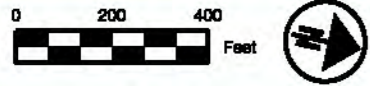

U.S. Department of Transportation  
Federal Highway Administration



Prepared by  
PARSONS  
BRINCKERHOFF

**POTENTIAL  
UTILITY IMPACTS**

SHEET  
(4 OF 7)

EXHIBIT  
20D

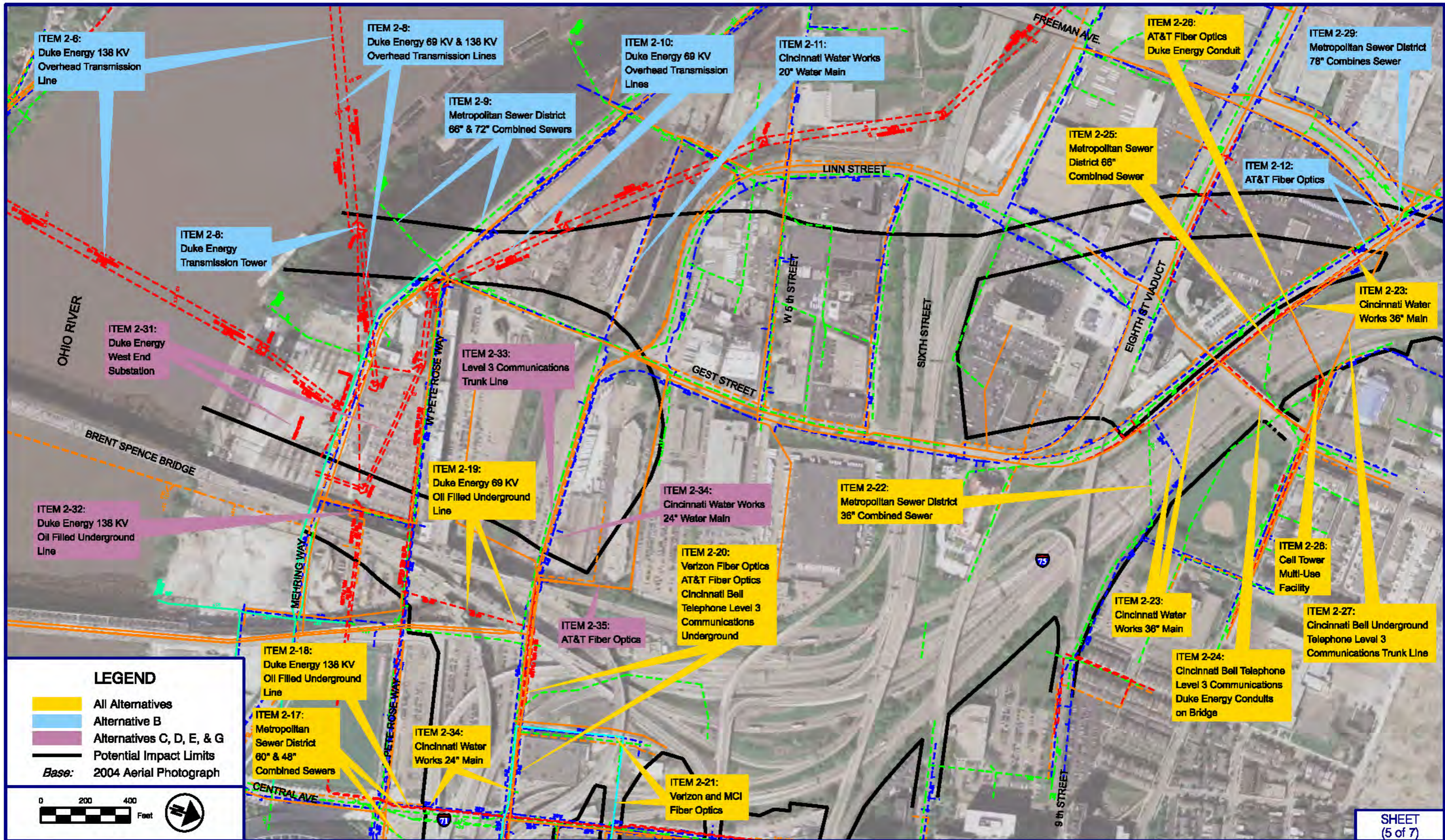

**LEGEND**

- All Alternatives
  - Alternative B
  - Alternatives C, D, E, & G
  - Potential Impact Limits
- Base:* 2004 Aerial Photograph



U.S. Department of Transportation  
Federal Highway Administration



Prepared by  
**PARSONS BRINCKERHOFF**

**POTENTIAL  
UTILITY IMPACTS**

SHEET  
(5 of 7)  
**EXHIBIT  
20E**

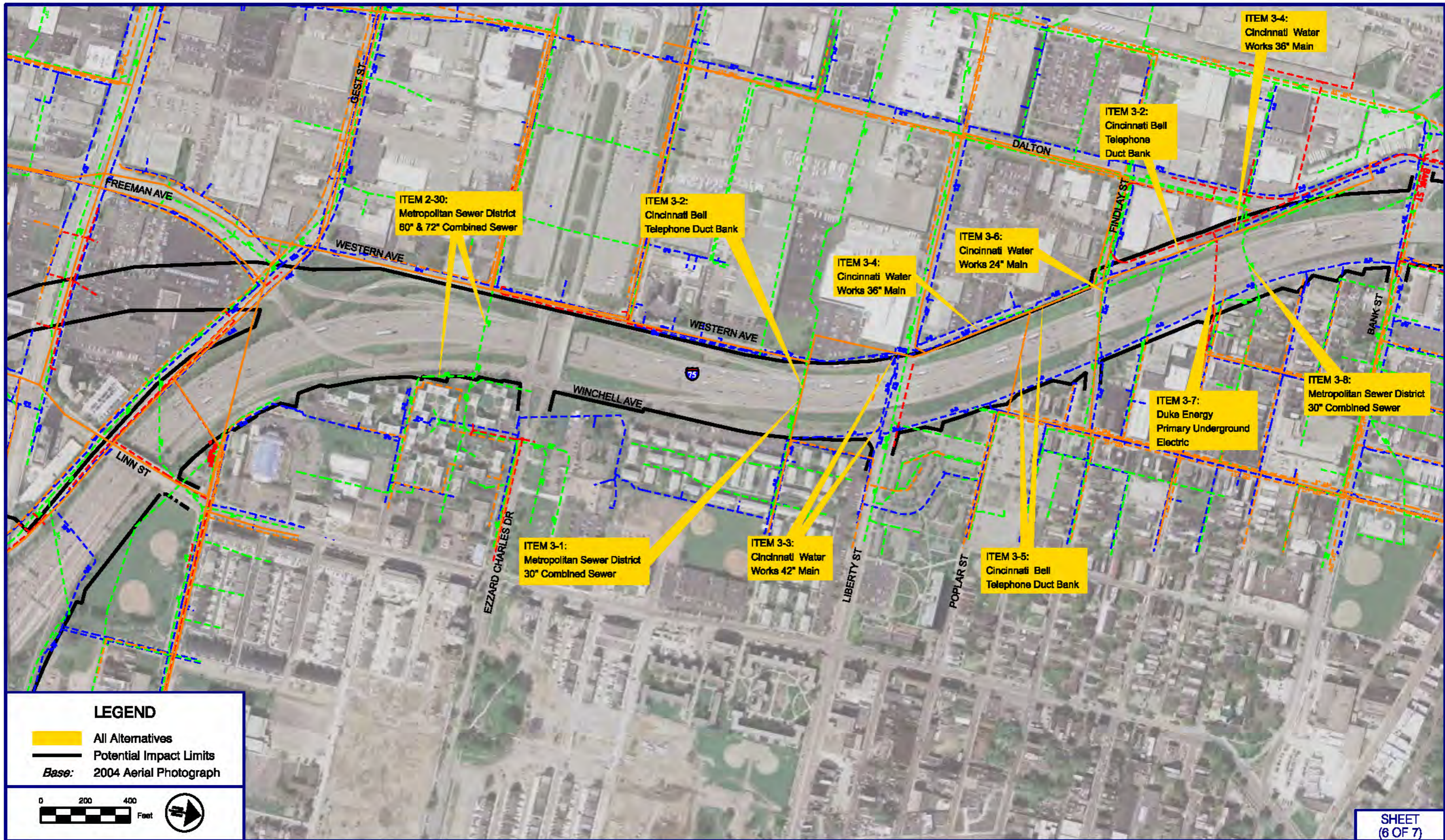

**LEGEND**

- All Alternatives
- Potential Impact Limits
- Base:* 2004 Aerial Photograph

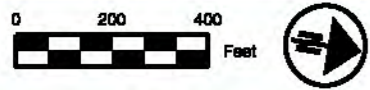

U.S. Department of Transportation  
Federal Highway Administration



Prepared by  
**PARSONS BRINCKERHOFF**

**POTENTIAL  
UTILITY IMPACTS**

SHEET  
(6 OF 7)

EXHIBIT  
20F

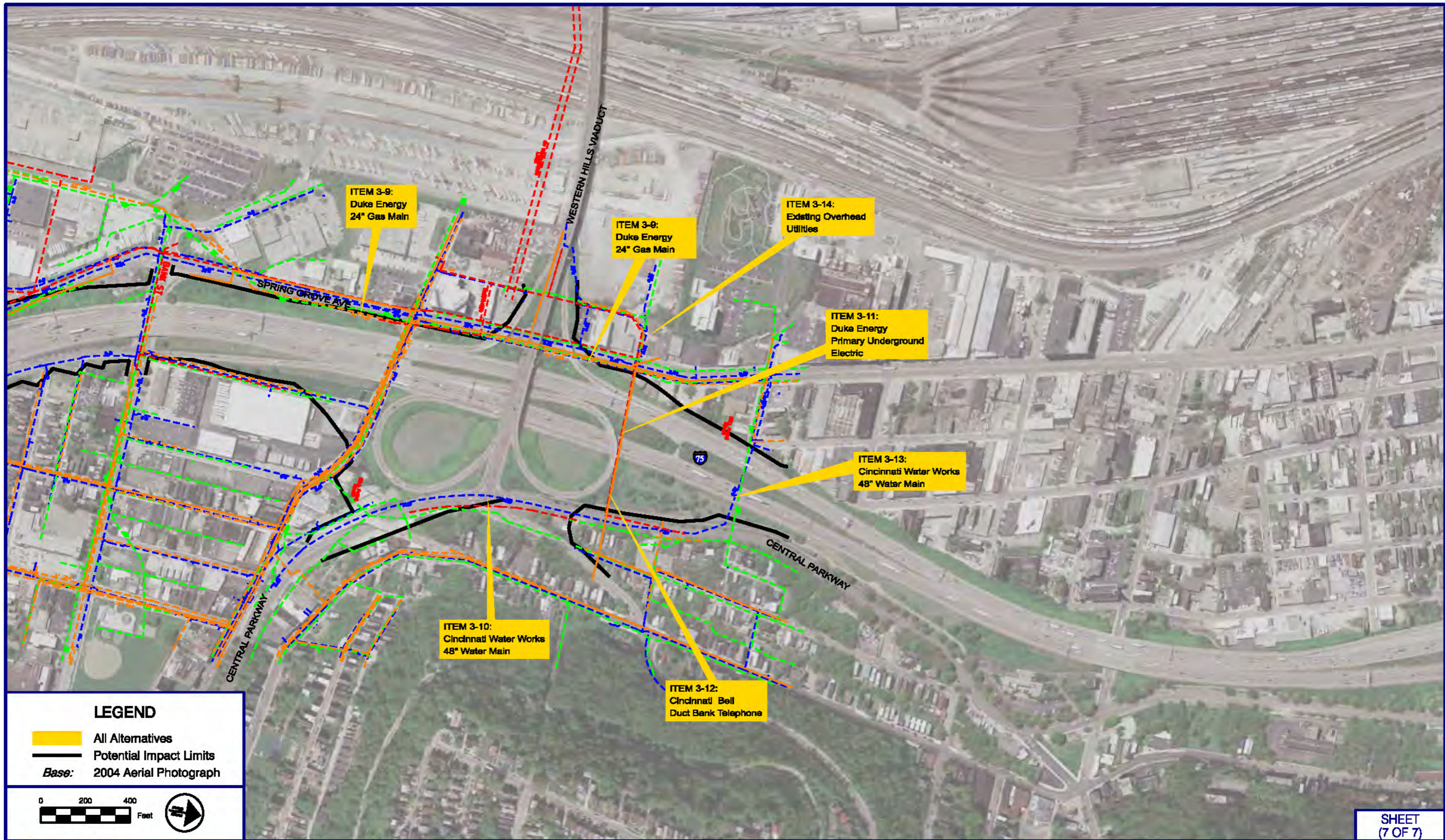

**LEGEND**

- All Alternatives
- Potential Impact Limits
- Base:* 2004 Aerial Photograph

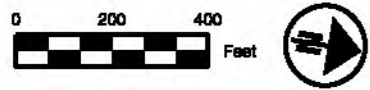

U.S. Department of Transportation  
Federal Highway Administration



Prepared by  
**PARSONS BRINCKERHOFF**

**POTENTIAL  
UTILITY IMPACTS**

SHEET  
(7 OF 7)

EXHIBIT  
20G

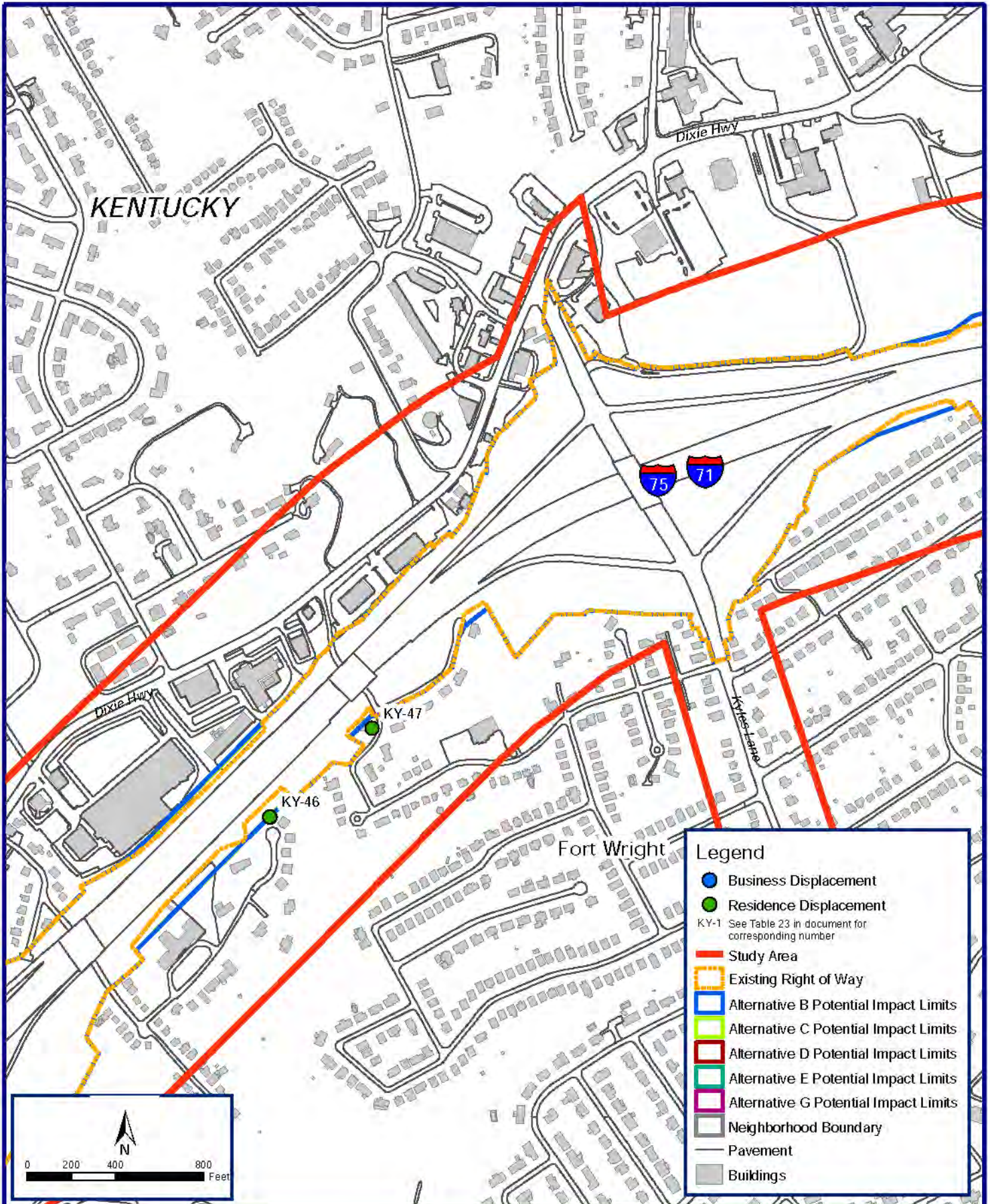

POTENTIAL DISPLACEMENTS (KENTUCKY)

EXHIBIT

21A



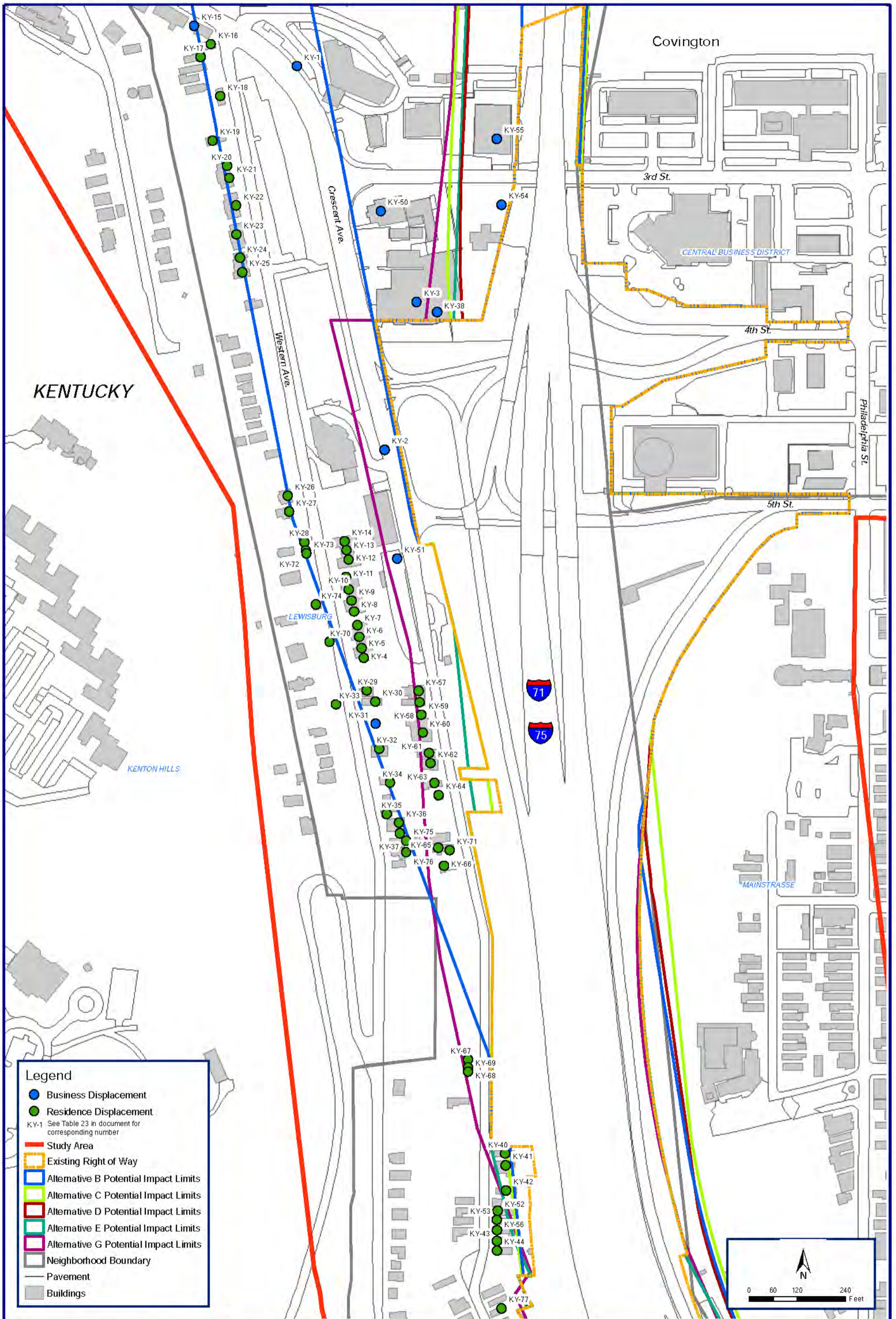

**Legend**

- Business Displacement
- Residence Displacement
- KY-1 See Table 23 in document for corresponding number
- Study Area
- Existing Right of Way
- Alternative B Potential Impact Limits
- Alternative C Potential Impact Limits
- Alternative D Potential Impact Limits
- Alternative E Potential Impact Limits
- Alternative G Potential Impact Limits
- Neighborhood Boundary
- Pavement
- Buildings

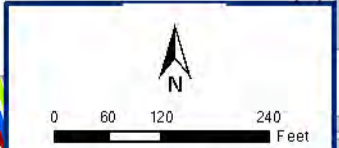

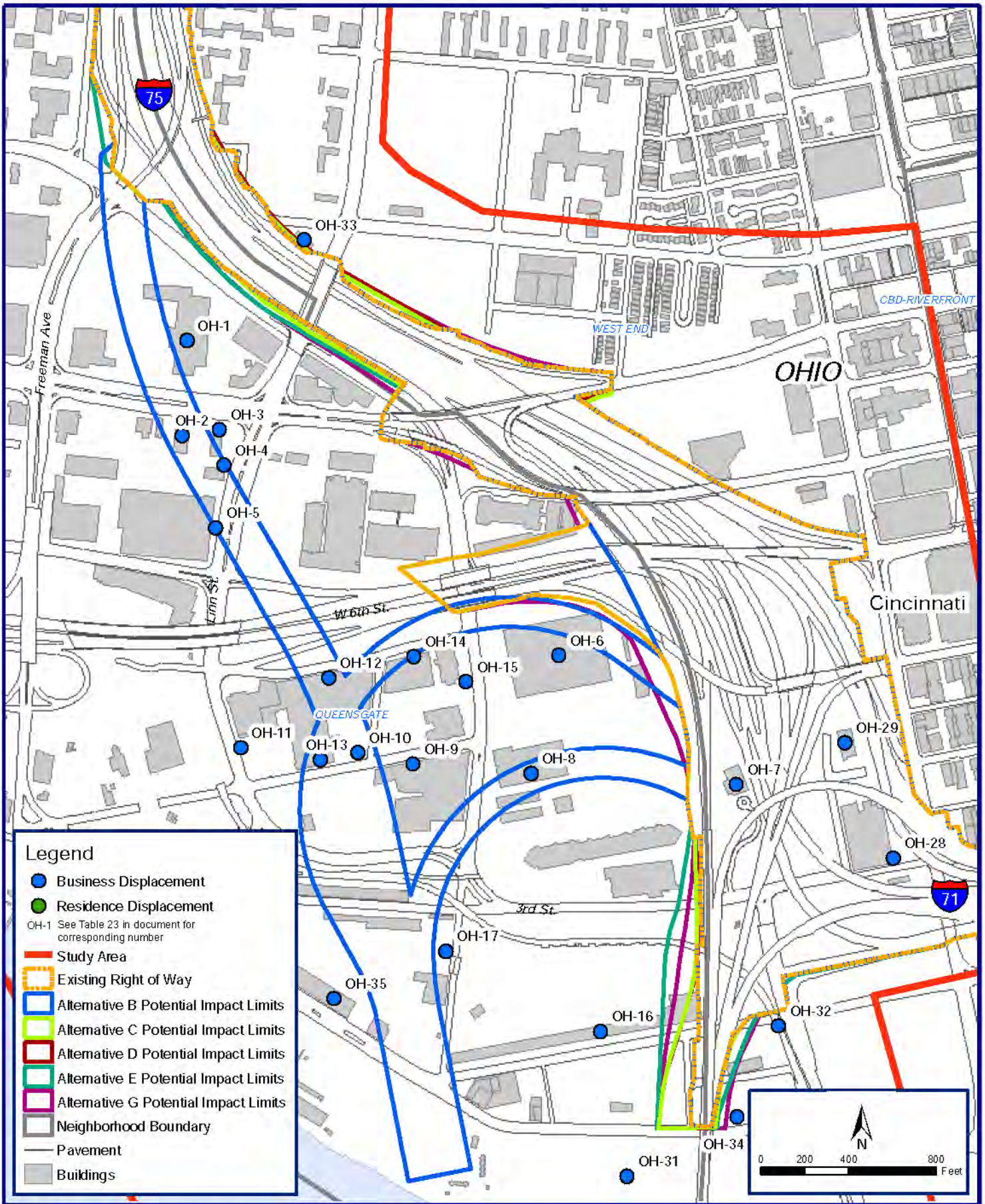

U.S. Department of Transportation  
Federal Highway Administration



POTENTIAL DISPLACEMENTS (OHIO)

**EXHIBIT**  
21C

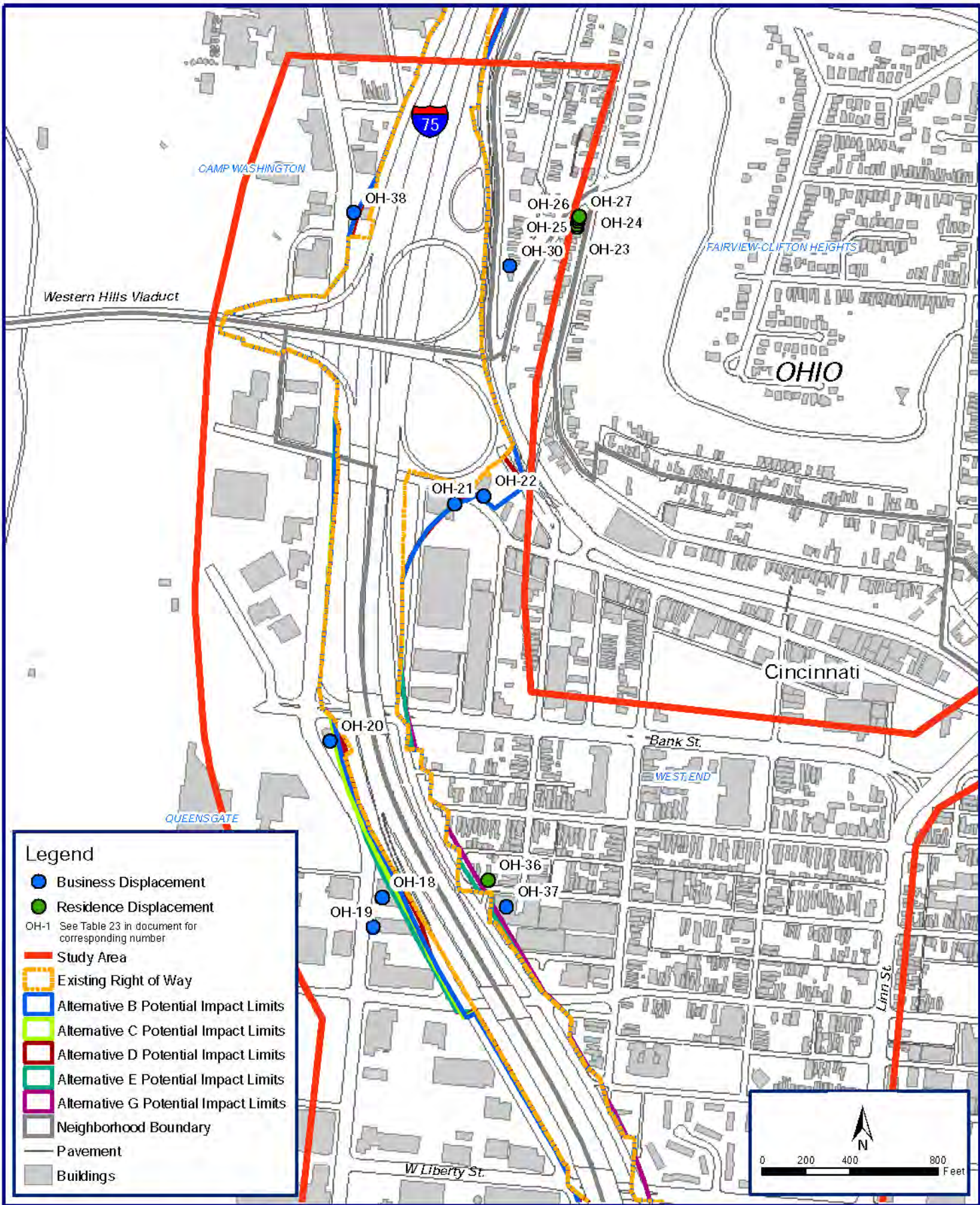

U.S. Department of Transportation  
Federal Highway Administration



POTENTIAL DISPLACEMENTS (OHIO)

**EXHIBIT**  
21D

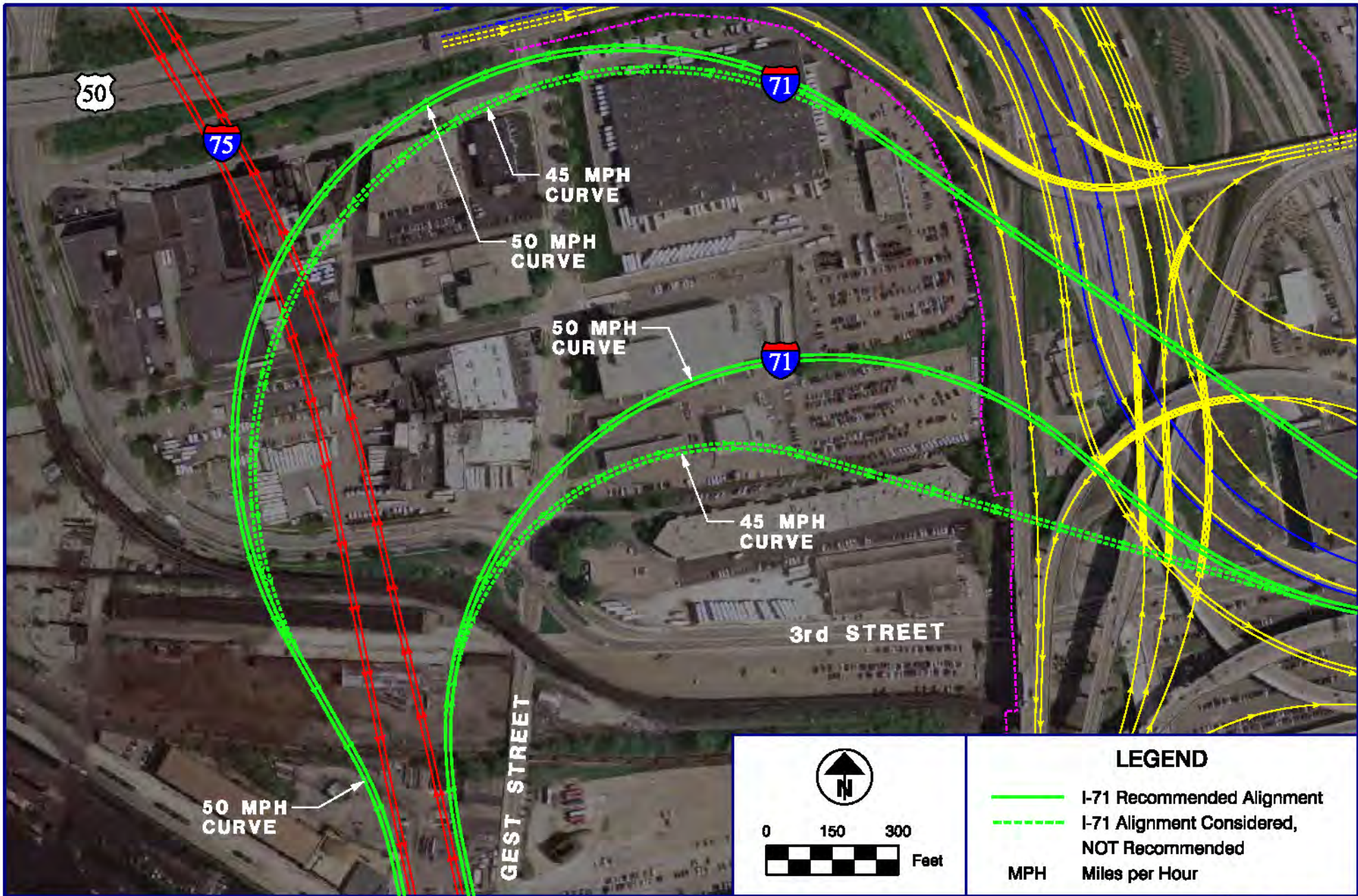

U.S. Department of Transportation  
Federal Highway Administration



**ALTERNATIVE B  
I-71 ALIGNMENT EVALUATION**

**EXHIBIT**

**22**

# **Appendix A**

## **Level of Service and Traffic Data**

## No Build Alternative Traffic Data - Freeway Segments

*Data Corresponds With Level of Service Exhibits*

No Build I-75 Freeway Segments								
Freeway Segment		Number of Lanes	Direction	Peak	Volume	Density	LOS	Volume/Capacity
From	To							
South of Dixie Highway	Dixie Highway Diverge	3	NB	AM	5760	38.4 pc/mi/ln	E	0.938
				PM	6570	-	F	1.075
Dixie Highway Diverge	Dixie Highway Merge	3	NB	AM	5490	34.8 pc/mi/ln	D	0.894
				PM	6210	-	F	1.016
Dixie Highway Merge	Kyles Lane Diverge	4	NB	AM	6430	30.75 pc/mi/ln*	D	0.791
				PM	6600	30.97 pc/mi/ln*	D	0.816
Kyles Lane Diverge	Kyles Lane Merge	3	NB	AM	5930	41.1 pc/mi/ln	E	0.966
				PM	5790	39.3 pc/mi/ln	E	0.947
Kyles Lane Merge	W 12th Street Diverge	3	NB	AM	7250	-	F	1.181
				PM	6410	-	F	1.048
W 12th Street Diverge	W 5th Street Diverge	3	NB	AM	7010	-	F	1.142
				PM	5860	40.4 pc/mi/ln	E	0.958
W 5th Street Diverge	Pike Street Merge	3	NB	AM	6370	-	F	1.027
				PM	5310	32.8 pc/mi/ln	D	0.865
Pike Street Merge	W 4th Street Merge	3	NB	AM	7490	-	F	1.208
				PM	5710	37.7 pc/mi/ln	E	0.930
W 4th Street Merge	I-71 NB Diverge	4	NB	AM	8650	-	F	1.092
				PM	6690	33.1 pc/mi/ln	D	0.844
I-71 NB Diverge	W 5th Street Diverge	3	NB	AM	3850	24.6 pc/mi/ln	C	0.642
				PM	4360	28.1 pc/mi/ln	D	0.734
W 5th Street Diverge	US 50 Diverge	2	NB	AM	3090	30.1 pc/mi/ln	D	0.780
				PM	3990	-	F	1.007
US 50 Diverge	I-71 SB Merge	2	NB	AM	2360	22.8 pc/mi/ln	C	0.596
				PM	3290	32.6 pc/mi/ln	D	0.835
I-71 SB Merge	W 9th Street Merge	4	NB	AM	4580	22.4 pc/mi/ln	C	0.584
				PM	6690	33.3 pc/mi/ln	D	0.849
W 9th Street Merge	Freeman Avenue Merge	4	NB	AM	4730	23.1 pc/mi/ln	C	0.603
				PM	7520	40.4 pc/mi/ln	E	0.954
Freeman Avenue Merge	Ezzard Charles Drive Merge	4	NB	AM	5220	25.4 pc/mi/ln	C	0.662
				PM	8080	-	F	1.025
Ezzard Charles Drive Merge	WHV Diverge	4	NB	AM	5350	26.0 pc/mi/ln	C	0.679
				PM	8480	-	F	1.076
WHV Diverge	WHV Merge	4	NB	AM	5030	24.5 pc/mi/ln	C	0.638
				PM	7950	-	F	1.008
North of WHV Merge		4	NB	AM	6040	29.5 pc/mi/ln	D	0.766
				PM	8860	-	F	1.124
North of WHV Diverge	WHV Diverge	4	SB	AM	9630	-	F	1.221
				PM	6530	32.3 pc/mi/ln	D	0.828
WHV Diverge	WHV Merge	4	SB	AM	9370	-	F	1.188
				PM	6030	29.4 pc/mi/ln	D	0.765
WHV Merge	Findlay Street Diverge	5	SB	AM	10170	-*	F	1.156
				PM	6430	28.82 pc/mi/ln*	D	0.725
Findlay Street Diverge	Ezzard Charles Drive Diverge	4	SB	AM	9430	-	F	1.196
				PM	5960	29.0 pc/mi/ln	D	0.756
Ezzard Charles Drive Diverge	Freeman Avenue Diverge	4	SB	AM	8810	-	F	1.123
				PM	5720	27.8 pc/mi/ln	D	0.726
Freeman Avenue Diverge	Ezzard Charles Drive Merge	4	SB	AM	8140	-	F	1.037
				PM	5260	25.6 pc/mi/ln	C	0.667
Ezzard Charles Drive Merge	W 7th Street Diverge	5	SB	AM	8410	38.03 pc/mi/ln*	E	0.905
				PM	5730	23.11 pc/mi/ln*	C	0.584
W 7th Street Diverge	I-71 NB Diverge	4	SB	AM	7080	36.6 pc/mi/ln	E	0.902
				PM	5550	27.0 pc/mi/ln	D	0.704
I-71 NB Diverge	W 9th Street Merge	2	SB	AM	3000	29.1 pc/mi/ln	D	0.757
				PM	2760	27.0 pc/mi/ln	D	0.703

\* Indicates Weave Segment

## No Build Alternative Traffic Data - Freeway Segments

Data Corresponds With Level of Service Exhibits

No Build I-75 Freeway Segments								
Freeway Segment		Number of Lanes	Direction	Peak	Volume	Density	LOS	Volume/Capacity
From	To							
W 9th Street Merge	US 50 Merge	2	SB	AM	3160	30.9 pc/mi/ln	D	0.798
				PM	3700	39.2 pc/mi/ln	E	0.939
US 50 Merge	I-71 SB Merge	2	SB	AM	3840	41.8 pc/mi/ln	E	0.969
				PM	4530	-	F	1.143
I-71 SB Merge	W 5th Street Diverge	4	SB	AM	6520	32.0 pc/mi/ln	D	0.823
				PM	8870	-	F	1.125
W 5th Street Diverge	Pike Street Diverge	4	SB	AM	5660	24.4 pc/mi/ln	C	0.701
				PM	8020	43.6 pc/mi/ln	E	0.989
W 5th Street	Pike Street (CD Weave)	2	SB	AM	940	12.37 pc/mi/ln*	B	N/A
				PM	2030	-*	F	N/A
Pike Street Diverge	W 4th Street Merge	4	SB	AM	5390	23.3 pc/mi/ln	C	0.674
				PM	7430	36.5 pc/mi/ln	E	0.916
W 4th Street Merge	W 12th Street Merge	4	SB	AM	5870	25.8 pc/mi/ln	C	0.734
				PM	8580	-	F	1.062
W 12th Street Merge	Kyles Lane Diverge	4	SB	AM	6220	27.8 pc/mi/ln	D	0.778
				PM	9160	-	F	1.134
Kyles Lane Diverge	Kyles Lane Merge	4	SB	AM	5620	24.5 pc/mi/ln	C	0.703
				PM	8140	-	F	1.008
Kyles Lane Merge	Dixie Highway Diverge	5	SB	AM	6060	22.96 pc/mi/ln*	C	0.618
				PM	8780	36.88 pc/mi/ln*	E	0.899
Dixie Highway Diverge	Dixie Highway Merge	4	SB	AM	5870	25.8 pc/mi/ln	C	0.734
				PM	8070	44.9 pc/mi/ln	E	0.999
South of Dixie Highway Merge		4	SB	AM	6200	27.7 pc/mi/ln	D	0.775
				PM	8650	-	F	1.071

No Build I-71 Freeway Segments								
Freeway Segment		Number of Lanes	Direction	Peak	Volume	Density	LOS	Volume/Capacity
From	To							
I-75 NB Diverge	W 2nd Street Diverge	2	NB	AM	4800	-	F	1.218
				PM	2330	22.6 pc/mi/ln	C	0.591
W 2nd Street Diverge	I-75 SB Merge	2	NB	AM	3600	37.3 pc/mi/ln	E	0.913
				PM	1900	18.6 pc/mi/ln	C	0.484
I-75 SB Merge	US 50 Diverge	4	NB	AM	7210	37.4 pc/mi/ln	E	0.915
				PM	4820	23.4 pc/mi/ln	C	0.611
US 50 Diverge	W 2nd Street Merge	2	NB	AM	5120	-	F	1.286
				PM	2390	23.0 pc/mi/ln	C	0.601
W 2nd Street Merge	W 5th Street Merge	3	NB	AM	5210	34.7 pc/mi/ln	D	0.873
				PM	2820	18.1 pc/mi/ln	C	0.472
W 5th Street Merge	I-471 Merge	3	NB	AM	5430	37.1 pc/mi/ln	E	0.910
				PM	3440	22.1 pc/mi/ln	C	0.576
I-471 Merge	Gilbert Street Merge	3	NB	AM	7400	-	F	1.233
				PM	4560	29.2 pc/mi/ln	D	0.760
North of I-471 Diverge		3	SB	AM	5350	35.9 pc/mi/ln	E	0.892
				PM	6330	-	F	1.055
I-471 Diverge	3rd Street Diverge	3	SB	AM	4700	30.4 pc/mi/ln	D	0.787
				PM	4820	31.3 pc/mi/ln	D	0.807
3rd Street Diverge	US 50 Merge	2	SB	AM	3030	29.3 pc/mi/ln	D	0.761
				PM	4290	-	F	1.078
US 50 Merge	I-75 NB Diverge	4	SB	AM	5270	25.6 pc/mi/ln	C	0.668
				PM	6190	30.3 pc/mi/ln	D	0.785
I-75 NB Diverge	W 3rd Street Merge	2	SB	AM	2420	23.5 pc/mi/ln	C	0.614
				PM	3140	31.5 pc/mi/ln	D	0.811
W 3rd Street Merge	I-75 SB Merge	2	SB	AM	2680	26.0 pc/mi/ln	D	0.680
				PM	4340	-	F	1.106

\* Indicates Weave Segment

## No Build Alternative Traffic Data - Freeway Segments

Data Corresponds With Level of Service Exhibits

No Build US 50 Freeway Segments								
Freeway Segment		Number of Lanes	Direction	Peak	Volume	Density	LOS	Volume/Capacity
From	To							
West of Freeman Avenue Diverge		3	EB	AM	3790	23.9 pc/mi/l <sub>n</sub>	C	0.623
				PM	1300	8.2 pc/mi/l <sub>n</sub>	A	0.215
Freeman Avenue Diverge	Freeman Avenue Merge	2	EB	AM	3040	28.8 pc/mi/l <sub>n</sub>	D	0.749
				PM	1120	10.6 pc/mi/l <sub>n</sub>	A	0.277
Freeman Avenue Merge	W 6th Street Merge	3	EB	AM	3110	21.42 pc/mi/l <sub>n</sub> *	C	0.566
				PM	1530	10.07 pc/mi/l <sub>n</sub> *	B	0.315
W 6th Street Merge	W 5th Street Diverge	4	EB	AM	3330	17.42 pc/mi/l <sub>n</sub> *	B	0.472
				PM	2290	12.46 pc/mi/l <sub>n</sub> *	B	0.368
W 5th Street Diverge	I-75 SB/I-71 NB Split	2	EB	AM	2770	26.2 pc/mi/l <sub>n</sub>	D	0.683
				PM	2140	20.3 pc/mi/l <sub>n</sub>	C	0.530
Central Avenue	I-75 NB/I-71 SB Merge	2	WB	AM	190	1.8 pc/mi/l <sub>n</sub>	A	0.047
				PM	960	9.1 pc/mi/l <sub>n</sub>	A	0.237
I-75 NB/I-71 SB Merge	Gest Street Diverge	4	WB	AM	1860	12.51 pc/mi/l <sub>n</sub> *	B	0.353
				PM	3110	23.79 pc/mi/l <sub>n</sub> *	C	0.588
Gest Street Diverge	Linn Street Diverge	4	WB	AM	1310	6.58 pc/mi/l <sub>n</sub> *	A	0.208
				PM	2730	14.29 pc/mi/l <sub>n</sub> *	B	0.400
Linn Street Diverge	Freeman Avenue Merge	3	WB	AM	740	4.7 pc/mi/l <sub>n</sub>	A	0.122
				PM	2460	15.6 pc/mi/l <sub>n</sub>	B	0.406
West of Freeman Avenue Merge		3	WB	AM	890	5.6 pc/mi/l <sub>n</sub>	A	0.147
				PM	3000	19.0 pc/mi/l <sub>n</sub>	C	0.495

No Build I-71/I-75 Connector Freeway Segments								
Freeway Segment		Number of Lanes	Direction	Peak	Volume	Density	LOS	Volume/Capacity
From	To							
I-75 SB Diverge	US 50 Diverge	2	NB	AM	2850	27.3 pc/mi/l <sub>n</sub>	D	0.713
				PM	3050	29.0 pc/mi/l <sub>n</sub>	D	0.755
US 50 Diverge	W 4th Street Merge	1	NB	AM	1910	40.2 pc/mi/l <sub>n</sub>	E	0.950
				PM	1600	30.2 pc/mi/l <sub>n</sub>	D	0.785
W 4th Street Merge	W 6th Street Merge	2	NB	AM	2200	21.0 pc/mi/l <sub>n</sub>	C	0.547
				PM	3200	30.4 pc/mi/l <sub>n</sub>	D	0.789
W 6th Street Merge	Winchell Diverge	4	NB	AM	2390	11.40 pc/mi/l <sub>n</sub> *	A	0.309
				PM	3720	18.97 pc/mi/l <sub>n</sub> *	B	0.499
Winchell Diverge	I-75 NB Merge	3	NB	AM	2200	14.4 pc/mi/l <sub>n</sub>	B	0.374
				PM	3400	21.4 pc/mi/l <sub>n</sub>	C	0.559
I-75 SB Diverge	W 5th Diverge	2	SB	AM	4080	-	F	1.010
				PM	2790	26.4 pc/mi/l <sub>n</sub>	D	0.688
W 5th Diverge	W 2nd Diverge	2	SB	AM	3370	32.6 pc/mi/l <sub>n</sub>	D	0.834
				PM	2540	24.0 pc/mi/l <sub>n</sub>	C	0.626
W 2nd Diverge	US 50 Merge	1	SB	AM	1860	38.5 pc/mi/l <sub>n</sub>	E	0.930
				PM	1730	33.6 pc/mi/l <sub>n</sub>	D	0.853
US 50 Merge	I-75 NB Merge	2	SB	AM	3610	36.0 pc/mi/l <sub>n</sub>	E	0.894
				PM	2920	27.6 pc/mi/l <sub>n</sub>	D	0.720

\* Indicates Weave Segment



## No Build Alternative Traffic Data - Intersections

*Data Corresponds With Level of Service Exhibits*

HCS Results - Signalized Intersections - 2035 No Build Volumes												
ID	Intersection	Peak	Eastbound		Westbound		Northbound		Southbound		Overall	
			Delay	LOS	Delay	LOS	Delay	LOS	Delay	LOS	Delay	LOS
OH-1	Bank Street & Dalton Avenue	AM	18.5s	B	21.1s	C	19.4s	B	20.8s	C	20.3s	C
		PM	18.0s	B	25.5s	C	22.0s	C	25.4s	C	24.2s	C
OH-2	Bank Street & Winchell Avenue	AM	12.1s	B	11.0s	B	11.8s	B	N/A	N/A	11.8s	B
		PM	13.1s	B	11.3s	B	12.7s	B	N/A	N/A	12.5s	B
OH-3	Central Pkwy & Linn Street	AM	27.0s	C	12.2s	B	13.7s	B	26.2s	C	22.8s	C
		PM	15.4s	B	29.4s	C	13.7s	B	30.5s	C	24.4s	C
OH-5	Findlay Street & Dalton Avenue	AM	16.8s	B	18.7s	B	18.8s	B	11.3s	B	15.2s	B
		PM	19.4s	B	20.0s	B	20.1s	C	10.4s	B	15.9s	B
OH-6	Findlay Street & Western Avenue	AM	13.7s	B	14.0s	B	N/A	N/A	14.0s	B	14.0s	B
		PM	13.9s	B	13.4s	B	N/A	N/A	13.7s	B	13.7s	B
OH-7	Findlay Street & Winchell Avenue	AM	14.0s	B	13.0s	B	14.1s	B	N/A	N/A	14.0s	B
		PM	14.4s	B	13.7s	B	14.4s	B	N/A	N/A	14.3s	B
OH-8	Liberty Street & Dalton Avenue	AM	11.6s	B	13.2s	B	11.3s	B	13.6s	B	12.5s	B
		PM	11.8s	B	15.0s	B	11.5s	B	14.4s	B	13.7s	B
OH-9	Liberty Street & Western Avenue	AM	11.4s	B	11.3s	B	N/A	N/A	11.4s	B	11.4s	B
		PM	11.4s	B	11.6s	B	N/A	N/A	11.3s	B	11.4s	B
OH-10	Liberty Street & Winchell Avenue	AM	11.9s	B	10.8s	B	12.2s	B	N/A	N/A	11.8s	B
		PM	11.4s	B	12.5s	B	12.4s	B	N/A	N/A	12.2s	B
OH-11	Liberty Street & Linn Street	AM	13.3s	B	13.0s	B	13.2s	B	13.0s	B	13.1s	B
		PM	12.0s	B	14.4s	B	14.5s	B	13.8s	B	13.9s	B
OH-12	Ezzard Charles WB & Western Avenue	AM	N/A	N/A	19.4s	B	N/A	N/A	19.2s	B	19.2s	B
		PM	N/A	N/A	19.3s	B	N/A	N/A	19.5s	B	19.5s	B
OH-13	Ezzard Charles WB & Winchell Avenue	AM	N/A	N/A	10.8s	B	11.0s	B	N/A	N/A	10.9s	B
		PM	N/A	N/A	11.8s	B	11.7s	B	N/A	N/A	11.7s	B
OH-14	Ezzard Charles EB & Western Avenue	AM	11.2s	B	N/A	N/A	N/A	N/A	11.3s	B	11.3s	B
		PM	11.2s	B	N/A	N/A	N/A	N/A	11.3s	B	11.3s	B
OH-15	Ezzard Charles EB & Winchell Avenue	AM	12.0s	B	N/A	N/A	12.4s	B	N/A	N/A	12.2s	B
		PM	11.2s	B	N/A	N/A	11.3s	B	N/A	N/A	11.2s	B
OH-16	Ezzard Charles & Linn Street	AM	14.0s	B	11.4s	B	13.8s	B	13.2s	B	13.5s	B
		PM	13.3s	B	14.0s	B	14.0s	B	13.2s	B	13.7s	B
OH-17	Gest Street & Dalton Avenue	AM	15.7s	B	15.9s	B	15.7s	B	15.9s	B	15.8s	B
		PM	17.2s	B	17.1s	B	13.9s	B	17.2s	B	16.6s	B
OH-18	Gest Street & Western Avenue	AM	15.4s	B	15.2s	B	N/A	N/A	15.2s	B	15.3s	B
		PM	15.2s	B	14.0s	B	N/A	N/A	15.5s	B	15.0s	B
OH-19	Gest Street & Freeman Avenue	AM	17.1s	B	27.0s	C	27.1s	C	27.0s	C	25.8s	C
		PM	16.3s	B	25.2s	C	25.2s	C	24.8s	C	23.3s	C
OH-20	Linn/W 3rd Street & Gest Street	AM	15.1s	B	17.7s	B	17.5s	B	9.9s	A	15.7s	B
		PM	16.4s	B	18.2s	B	18.6s	B	10.4s	B	16.5s	B
OH-23	8th Street & Dalton Avenue	AM	13.9s	B	20.7s	C	17.9s	B	20.5s	C	17.3s	B
		PM	12.6s	B	22.2s	C	18.0s	B	22.6s	C	20.2s	C
OH-24	8th Street & Freeman Avenue	AM	24.4s	C	21.4s	C	24.4s	C	21.8s	C	23.4s	C
		PM	23.7s	C	21.9s	C	22.3s	C	23.6s	C	22.8s	C
OH-25	8th Street & Linn Street	AM	22.0s	C	19.6s	B	20.5s	C	21.7s	C	21.4s	C
		PM	24.1s	C	24.3s	C	24.4s	C	23.3s	C	24.1s	C
OH-26	WHV LL & Spring Grove Avenue	AM	16.6s	B	N/A	N/A	8.4s	A	16.9s	B	14.2s	B
		PM	19.9s	B	N/A	N/A	9.6s	A	20.1s	C	13.8s	B
OH-27	Dalton Avenue & Linn Street	AM	14.3s	B	15.7s	B	15.3s	B	14.1s	B	15.1s	B
		PM	20.3s	C	10.5s	B	20.4s	C	18.7s	B	18.1s	B
OH-29	W Court Street & Central Avenue	AM	18.4s	B	13.7s	B	18.3s	B	N/A	N/A	17.7s	B
		PM	13.1s	B	14.3s	B	14.4s	B	N/A	N/A	14.1s	B
OH-30	W 9th Street & Central Avenue	AM	N/A	N/A	13.4s	B	13.4s	B	12.3s	B	13.4s	B
		PM	N/A	N/A	17.3s	B	17.8s	B	17.0s	B	17.4s	B
OH-31	W 7th Street & Central Avenue	AM	18.0s	B	N/A	N/A	18.6s	B	N/A	N/A	18.1s	B
		PM	13.9s	B	N/A	N/A	13.8s	B	N/A	N/A	13.9s	B
OH-32	W 6th Street & Central Avenue	AM	N/A	N/A	15.0s	B	15.3s	B	N/A	N/A	15.1s	B
		PM	N/A	N/A	17.0s	B	17.2s	B	N/A	N/A	17.0s	B

## No Build Alternative Traffic Data - Intersections

*Data Corresponds With Level of Service Exhibits*

HCS Results - Signalized Intersections - 2035 No Build Volumes												
ID	Intersection	Peak	Eastbound		Westbound		Northbound		Southbound		Overall	
			Delay	LOS	Delay	LOS	Delay	LOS	Delay	LOS	Delay	LOS
OH-33	W 5th Street & Central Avenue	AM	31.2s	C	N/A	N/A	32.0s	C	20.1s	C	30.8s	C
		PM	22.1s	C	N/A	N/A	21.7s	C	16.2s	B	21.1s	C
OH-34	W 4th Street & Central Avenue	AM	N/A	N/A	18.9s	B	15.9s	B	18.9s	B	17.7s	B
		PM	N/A	N/A	51.2s	D	51.2s	D	33.5s	C	50.1s	D
OH-35	W 3rd Street & Central Avenue	AM	46.8s	D	46.6s	D	35.1s	D	46.6s	D	46.2s	D
		PM	54.8s	D	55.1s	E	44.4s	D	56.0s	E	51.7s	D
OH-36	W 4th Street & Plum Street	AM	N/A	N/A	13.0s	B	N/A	N/A	13.0s	B	13.0s	B
		PM	N/A	N/A	15.2s	B	N/A	N/A	15.1s	B	15.2s	B
OH-37	W 3rd Street & Plum Street	AM	N/A	N/A	13.6s	B	N/A	N/A	14.0s	B	13.7s	B
		PM	N/A	N/A	14.2s	B	N/A	N/A	14.0s	B	14.1s	B
OH-38	W 4th Street & Elm Street	AM	N/A	N/A	14.5s	B	14.6s	B	N/A	N/A	14.6s	B
		PM	N/A	N/A	17.1s	B	16.9s	B	N/A	N/A	17.0s	B
OH-39	W 3rd Street & Elm Street	AM	N/A	N/A	15.7s	B	15.4s	B	N/A	N/A	15.6s	B
		PM	N/A	N/A	16.3s	B	16.5s	B	N/A	N/A	16.4s	B
OH-40	W 2nd Street & Elm Street	AM	18.1s	B	N/A	N/A	17.8s	B	N/A	N/A	18.1s	B
		PM	16.7s	B	N/A	N/A	17.1s	B	N/A	N/A	16.8s	B
OH-41	W 3rd Street & Clay Wade Bailey Bridge	AM	22.4s	C	22.9s	C	22.6s	C	N/A	N/A	22.6s	C
		PM	61.3s	E	58.2s	E	52.2s	D	N/A	N/A	57.8s	E
OH-43	W McMillan Street & Central Pkwy	AM	31.7s	C	12.6s	B	19.2s	B	33.2s	C	29.0s	C
		PM	37.7s	D	21.5s	C	27.4s	C	36.0s	D	30.2s	C
OH-44	W McMillan Street & W McMicken Avenue	AM	16.5s	B	7.4s	A	15.8s	B	16.1s	B	14.7s	B
		PM	15.4s	B	9.1s	A	14.7s	B	15.3s	B	12.1s	B
OH-47	W McMillan Street/Fairview Avenue/ Ravine Street	AM	See Below									
		PM	See Below									
KY-2	W 4th Street & Philadelphia Street	AM	N/A	N/A	39.3s	D	9.3s	A	41.0s	D	33.7s	C
		PM	N/A	N/A	65.9s	E	16.6s	B	66.5s	E	57.0s	E
KY-3	W 4th Street & Bakewell Street	AM	N/A	N/A	14.5s	B	14.0s	B	14.7s	B	14.5s	B
		PM	N/A	N/A	16.4s	B	15.9s	B	16.2s	B	16.3s	B
KY-4	W 4th Street & Main Street	AM	N/A	N/A	20.7s	C	20.4s	C	9.2s	A	18.2s	B
		PM	N/A	N/A	25.9s	C	14.2s	B	27.0s	C	24.8s	C
KY-7	W 5th Street & Philadelphia Street	AM	18.8s	B	N/A	N/A	19.5s	B	19.2s	B	18.9s	B
		PM	17.5s	B	N/A	N/A	16.0s	B	17.0s	B	17.2s	B
KY-9	W 5th Street & Main Street	AM	22.0s	C	N/A	N/A	21.9s	C	22.0s	C	22.0s	C
		PM	20.5s	C	N/A	N/A	11.7s	B	21.3s	C	19.5s	B
KY-10	Pike Street & Bullock Street	AM	43.5s	D	12.9s	B	N/A	N/A	41.8s	D	38.3s	D
		PM	39.1s	D	37.5s	D	N/A	N/A	38.2s	D	38.1s	D
KY-11	Pike Street & Jillians Way	AM	56.8s	E	6.5s	A	55.1s	E	N/A	N/A	49.2s	D
		PM	20.5s	C	17.6s	B	20.4s	C	N/A	N/A	19.2s	B
KY-14	Dixie Hwy & Kyles Lane	AM	134.6s	F	116.1s	F	125.0s	F	40.8s	D	125.0s	F
		PM	84.9s	F	86.2s	F	83.0s	F	22.2s	C	84.1s	F
KY-15	I75 SB Ramps & Kyles Lane	AM	N/A	N/A	22.6s	C	15.1s	B	21.9s	C	19.3s	B
		PM	N/A	N/A	61.8s	E	30.4s	C	58.3s	E	48.7s	D
KY-16	I75 NB Ramps & Kyles Lane	AM	112.2s	F	N/A	N/A	121.6s	F	6.1s	A	82.8s	F
		PM	30.0s	C	N/A	N/A	31.7s	C	16.9s	B	25.5s	C
KY-17	Higland Avenue & Kyles Lane	AM	30.0s	C	186.6s	F	176.5s	F	17.6s	B	128.9s	F
		PM	62.4s	E	161.8s	F	101.0s	F	236.0s	F	171.5s	F
KY-18	I75 SB Ramps & Dixie Hwy	AM	N/A	N/A	17.6s	B	16.7s	B	17.6s	B	17.0s	B
		PM	N/A	N/A	23.8s	C	8.8s	A	23.0s	C	19.2s	B
KY-19	I75 NB Ramps & Dixie Hwy	AM	25.6s	C	N/A	N/A	25.0s	C	8.6s	A	20.8s	C
		PM	18.4s	B	N/A	N/A	18.6s	B	14.9s	B	16.4s	B

ID	Intersection	Peak	Eastbound		Westbound		Northbound		Southbound		Northeastbound	
			Delay	LOS	Delay	LOS	Delay	LOS	Delay	LOS	Delay	LOS
OH-47	W McMillan Street/Fairview Avenue/ Ravine Street	AM	20.0s	C	14.8s	B	27.7s	C	22.6s	C	36.2s	D
		PM	20.2s	C	25.0s	C	24.9s	C	17.7s	B	35.8s	D
			Southwestbound		Overall							
			Delay	LOS	Delay	LOS						
			33.1s	C	21.1s	C						
			37.6s	D	25.6s	C						

## No Build Alternative Traffic Data - Intersections

*Data Corresponds With Level of Service Exhibits*

HCS Results - Unsignalized Intersections - 2035 No Build Volumes												
ID	Intersection	Peak	Eastbound		Westbound		Northbound		Southbound		Overall	
			Delay	LOS	Delay	LOS	Delay	LOS	Delay	LOS	Delay	LOS
OH-4	Bank Street & Linn Street	AM	9.9s	A	N/A	N/A	7.6s [L]	A	N/A	N/A	N/A	N/A
		PM	11.3s	B	N/A	N/A	8.0s [L]	A	N/A	N/A	N/A	N/A
OH-21	Court Street & Linn Street	AM	16.5s	C	14.0s	B	7.8s [L]	A	8.9s [L]	A	N/A	N/A
		PM	19.4s	C	22.8s	C	8.3s [L]	A	8.7s [L]	A	N/A	N/A
OH-28	W 6th Street & Linn Street	AM	N/A	N/A	N/A	N/A	N/A	N/A	8.4s [L]	A	N/A	N/A
		PM	N/A	N/A	N/A	N/A	N/A	N/A	13.8s [L]	B	N/A	N/A
OH-45	Clemmer Avenue & W McMillan Street	AM	N/A	N/A	13.1s	B	N/A	N/A	7.8s [L]	A	N/A	N/A
		PM	N/A	N/A	16.2s	C	N/A	N/A	8.8s [L]	A	N/A	N/A
OH-46	W McMillan Street & Scenic Drive	AM	N/A	N/A	N/A	N/A	9.3s [L]	A	N/A	N/A	N/A	N/A
		PM	N/A	N/A	N/A	N/A	8.0s [L]	A	N/A	N/A	N/A	N/A
OH-48	W McMillan Street & Flora Avenue	AM	N/A	N/A	9.3s [L]	A	10.6s	B	N/A	N/A	N/A	N/A
		PM	N/A	N/A	8.3s [L]	A	9.6s	A	N/A	N/A	N/A	N/A
OH-49	W McMillan Street & Victor Avenue	AM	N/A	N/A	9.3s [L]	A	14.4s	B	N/A	N/A	N/A	N/A
		PM	N/A	N/A	8.3s [L]	A	12.5s	B	N/A	N/A	N/A	N/A
KY-1	W 4th Street & Crescent Avenue	AM	N/A	N/A	26.0s	D	N/A	N/A	8.4s [L]	A	N/A	N/A
		PM	N/A	N/A	33.3s	D	N/A	N/A	9.1s [L]	A	N/A	N/A
KY-6	W 5th Street & Crescent Avenue	AM	N/A	N/A	11.4s	B	N/A	N/A	7.7s [L]	A	N/A	N/A
		PM	N/A	N/A	15.2s	C	N/A	N/A	7.6s [L]	A	N/A	N/A
KY-8	W 5th Street & Bakewell Street	AM	7.3s [L]	A	N/A	N/A	28.3s	D	47.6s	E	N/A	N/A
		PM	7.3s [L]	A	N/A	N/A	19.4s	C	21.7s	C	N/A	N/A
KY-12	W 12th Street & Bullock Street	AM	18.35s	C	15.09s	C	N/A	N/A	13.80s	B	15.61s	C
		PM	11.67s	B	16.73s	C	N/A	N/A	15.64s	C	15.38s	C
KY-13	W 12th Street & Jillians Way	AM	100.10s	F	80.72s	F	15.48s	C	N/A	N/A	78.14s	F
		PM	60.43s	F	128.39s	F	80.51s	F	N/A	N/A	92.36s	F

## No Build Alternative Traffic Data - Ramp Segments

*Data Corresponds With Level of Service Exhibits*

No Build I-75 Ramp Junctions					
Ramp Junction	Direction	Ramp Volume	Peak	Density	LOS
Dixie Highway Diverge	NB	270	AM	37.3 pc/mi/ln	E
		360	PM	-	F
Kyles Lane Merge	NB	1320	AM	-	F
		620	PM	-	F
W 12th Street Diverge	NB	240	AM	-	F
		550	PM	-	F
W 5th Street Diverge	NB	640	AM	-	F
		550	PM	38.6 pc/mi/ln	E
Pike Street Merge	NB	1120	AM	-	F
		400	PM	33.6 pc/mi/ln	D
W 4th Street Merge	NB	1160	AM	-	F
		980	PM	37.7 pc/mi/ln	E
I-71 NB Split	NB	4800	AM	-	F
		2330	PM	33.1 pc/mi/ln	D
W 5th Street Diverge	NB	760	AM	30.1 pc/mi/ln	D
		370	PM	-	F
US 50 Diverge	NB	730	AM	33.1 pc/mi/ln	D
		700	PM	-	F
I-71 SB Merge	NB	2220	AM	22.8 pc/mi/ln	C
		3400	PM	33.3 pc/mi/ln	D
W 9th Street Merge	NB	150	AM	19.4 pc/mi/ln	B
		830	PM	32.6 pc/mi/ln	D
Freeman Avenue Merge	NB	490	AM	23.7 pc/mi/ln	C
		560	PM	-	F
Ezzard Charles Drive Merge	NB	130	AM	20.1 pc/mi/ln	C
		400	PM	-	F
WHV Diverge	NB	320	AM	26.1 pc/mi/ln	C
		530	PM	-	F
WHV/Bank Ramps	NB	250	AM	21.2 pc/mi/ln	C
		540	PM	19.2 pc/mi/ln	C
WHV/Bank Street Merge	NB	1010	AM	28.4 pc/mi/ln	D
		910	PM	-	F
WHV Diverge	SB	260	AM	-	F
		500	PM	30.6 pc/mi/ln	D
Ezzard Charles Drive Diverge	SB	620	AM	-	F
		240	PM	26.7 pc/mi/ln	C
Freeman Avenue Diverge	SB	670	AM	-	F
		460	PM	26.2 pc/mi/ln	C
I-71 NB Split	SB	4080	AM	-	F
		2790	PM	27.0 pc/mi/ln	D
W 9th Street Merge	SB	160	AM	30.2 pc/mi/ln	D
		940	PM	34.7 pc/mi/ln	D
US 50 Merge	SB	680	AM	36.8 pc/mi/ln	E
		830	PM	-	F
I-71 SB Merge	SB	2680	AM	41.8 pc/mi/ln	E
		4340	PM	-	F
W 5th Street Diverge	SB	860	AM	35.3 pc/mi/ln	E
		850	PM	-	F
Pike Street Diverge	SB	270	AM	-	F
		590	PM	-	F
W 5th Street Merge	SB	480	AM	27.7 pc/mi/ln	C
		1150	PM	-	F
W 12th Street Merge	SB	350	AM	26.9 pc/mi/ln	C
		580	PM	-	F
Kyles Lane Diverge	SB	600	AM	33.3 pc/mi/ln	D
		1020	PM	-	F
Dixie Highway Merge	SB	330	AM	25.5 pc/mi/ln	C
		580	PM	-	F

## No Build Alternative Traffic Data - Ramp Segments

*Data Corresponds With Level of Service Exhibits*

No Build I-71 Ramp Junctions					
Ramp Junction	Direction	Ramp Volume	Peak	Density	LOS
W 2nd Street Diverge	NB	1200	AM	-	F
		430	PM	23.6 pc/mi/l <sub>n</sub>	C
I-75 SB Merge	NB	3610	AM	37.4 pc/mi/l <sub>n</sub>	E
		2920	PM	27.6 pc/mi/l <sub>n</sub>	D
US 50 Diverge	NB	2090	AM	-	F
		2430	PM	23.4 pc/mi/l <sub>n</sub>	C
W 2nd Street Merge	NB	90	AM	-	F
		430	PM	23.0 pc/mi/l <sub>n</sub>	C
W 5th Street Merge	NB	220	AM	32.3 pc/mi/l <sub>n</sub>	D
		620	PM	23.0 pc/mi/l <sub>n</sub>	C
I-471 Merge	NB	1970	AM	-	F
		1120	PM	30.7 pc/mi/l <sub>n</sub>	D
I-471 Diverge	SB	650	AM	34.1 pc/mi/l <sub>n</sub>	D
		1510	PM	-	F
W 3rd Street Diverge	SB	1670	AM	34.9 pc/mi/l <sub>n</sub>	D
		530	PM	-	F
US 50 Merge	SB	2240	AM	29.3 pc/mi/l <sub>n</sub>	D
		1900	PM	-	F
I-75 NB Diverge	SB	2850	AM	27.3 pc/mi/l <sub>n</sub>	D
		3050	PM	31.5 pc/mi/l <sub>n</sub>	D
W 3rd Street Merge	SB	260	AM	26.4 pc/mi/l <sub>n</sub>	C
		1200	PM	-	F

No Build US 50 Ramp Junctions					
Ramp Junction	Direction	Ramp Volume	Peak	Density	LOS
Freeman Avenue Diverge	EB	750	AM	28.8 pc/mi/l <sub>n</sub>	D
		180	PM	10.6 pc/mi/l <sub>n</sub>	A
I-75 SB/I-71 NB Split	EB	1750	AM	33.9 pc/mi/l <sub>n</sub>	D
		1190	PM	22.5 pc/mi/l <sub>n</sub>	C
I-75 NB Merge	WB	940	AM	18.0 pc/mi/l <sub>n</sub>	C
		1450	PM	27.7 pc/mi/l <sub>n</sub>	D
Freeman Avenue Merge	WB	150	AM	5.8 pc/mi/l <sub>n</sub>	A
		540	PM	18.1 pc/mi/l <sub>n</sub>	B

No Build I-71/I-75 Connector Ramp Junctions					
Ramp Junction	Direction	Ramp Volume	Peak	Density	LOS
US 50 Diverge	NB	940	AM	40.2 pc/mi/l <sub>n</sub>	E
		1450	PM	30.2 pc/mi/l <sub>n</sub>	D
W 4th Merge	NB	290	AM	40.2 pc/mi/l <sub>n</sub>	E
		1600	PM	33.0 pc/mi/l <sub>n</sub>	D
W 5th Street Diverge	SB	710	AM	-	F
		250	PM	30.5 pc/mi/l <sub>n</sub>	D
W 2nd Street Diverge	SB	1510	AM	38.5 pc/mi/l <sub>n</sub>	E
		810	PM	33.6 pc/mi/l <sub>n</sub>	D
US 50 Merge	SB	1750	AM	38.5 pc/mi/l <sub>n</sub>	E
		1190	PM	33.6 pc/mi/l <sub>n</sub>	D

## Alternative B Traffic Data - Freeway Segments

*Data Corresponds With Level of Service Exhibits*

Alternative B I-75 Freeway Segments								
Freeway Segment		Direction	Number of Lanes	Peak	Volume	Density	LOS	Volume/Capacity
From	To							
South of Dixie Highway	Dixie Highway Diverge	NB	3	AM	7160	-	F	1.216
				PM	8280	-	F	1.413
Dixie Highway Diverge	Dixie Highway Merge	NB	3	AM	6440	-	F	1.094
				PM	7180	-	F	1.225
Dixie Highway Merge	Kyles Lane Merge	NB	5	AM	7440	29.1 pc/mi/ln	D	0.758
				PM	7560	29.8 pc/mi/ln	D	0.774
Kyles Lane Merge	Local CD Diverge	NB	6	AM	8910	29.1 pc/mi/ln	D	0.757
				PM	8270	27.1 pc/mi/ln	D	0.706
Local CD Diverge	W 5th Merge	NB	4	AM	6070	29.5 pc/mi/ln	D	0.766
				PM	6260	30.9 pc/mi/ln	D	0.798
W 5th Merge	I-71 NB Diverge	NB	4	AM	6920	34.8 pc/mi/ln	D	0.873
				PM	6660	33.4 pc/mi/ln	D	0.849
I-71 NB Diverge	I-71 SB/ Local CD Merge	NB	2	AM	2450	23.7 pc/mi/ln	C	0.618
				PM	4000	-	F	1.019
I-71 SB/ Local CD Merge	WHV/Central Pkwy Diverge	NB	5	AM	5640	21.9 pc/mi/ln	C	0.572
				PM	8290	32.9 pc/mi/ln	D	0.841
WHV/Central Pkwy Diverge	WHV Merge	NB	5	AM	4070	15.8 pc/mi/ln	B	0.413
				PM	7340	28.6 pc/mi/ln	D	0.745
WHV Merge	Central Pkwy Merge	NB	6	AM	5640	18.3 pc/mi/ln	C	0.477
				PM	8560	27.7 pc/mi/ln	D	0.724
North of Central Pkwy Merge		NB	6	AM	6150	19.9 pc/mi/ln	C	0.520
				PM	8790	28.5 pc/mi/ln	D	0.743
North of WHV Diverge	WHV Diverge	SB	5	AM	9780	44.1 pc/mi/ln	E	0.992
				PM	7230	28.1 pc/mi/ln	D	0.734
WHV Diverge	Findlay Diverge	SB	5	AM	8670	35.1 pc/mi/ln	E	0.880
				PM	6720	26.1 pc/mi/ln	D	0.682
Findlay Diverge	I-71 NB/Local CD Diverge	SB	5	AM	8400	33.5 pc/mi/ln	D	0.852
				PM	6270	24.4 pc/mi/ln	C	0.636
I-71 NB/Local CD Diverge	I-71 SB Merge	SB	2	AM	3920	44.4 pc/mi/ln	E	0.994
				PM	2730	26.5 pc/mi/ln	D	0.693
I-71 SB Merge	Local CD Merge	SB	4	AM	6230	30.5 pc/mi/ln	D	0.790
				PM	5900	29.2 pc/mi/ln	D	0.759
Local CD Merge	W 12th Merge	SB	5	AM	6560	26.0 pc/mi/ln	C	0.678
				PM	8930	37.7 pc/mi/ln	E	0.919
W 12th Merge	Kyles/Dixie Diverge	SB	6	AM	7340	24.5 pc/mi/ln	C	0.638
				PM	10390	36.1 pc/mi/ln	E	0.895
Kyles/Dixie Diverge	Kyles CD Merge	SB	4	AM	6460	33.0 pc/mi/ln	D	0.842
				PM	8570	-	F	1.107
Kyles CD Merge	Dixie Highway Merge	SB	5	AM	6810	27.2 pc/mi/ln	D	0.710
				PM	9130	39.6 pc/mi/ln	E	0.944
South of Dixie Merge		SB	4	AM	7150	38.7 pc/mi/ln	E	0.932
				PM	9760	-	F	1.261

Alternative B I-71 Freeway Segments								
Freeway Segment		Direction	Number of Lanes	Peak	Volume	Density	LOS	Volume/Capacity
From	To							
I-75 NB Diverge	US 50/I-75 SB Merge	NB	2	AM	4470	-	F	1.134
				PM	2660	26.0 pc/mi/ln	C	0.678
US 50/I-75 SB Merge	US 50 Diverge	NB	4	AM	7480	40.0 pc/mi/ln	E	0.949
				PM	5020	24.4 pc/mi/ln	C	0.637
US 50 Diverge	W 2nd Merge	NB	2	AM	5320	-	F	1.337
				PM	2510	24.2 pc/mi/ln	C	0.631
W 2nd Merge	W 5th Merge	NB	3	AM	5380	36.5 pc/mi/ln	E	0.901
				PM	2800	18.0 pc/mi/ln	B	0.469

\* Indicates Weave Segments

## Alternative B Traffic Data - Freeway Segments

*Data Corresponds With Level of Service Exhibits*

Alternative B I-71 Freeway Segments								
Freeway Segment		Direction	Number of Lanes	Peak	Volume	Density	LOS	Volume/Capacity
From	To							
W 5th Merge	I-471 Merge	NB	3	AM	5570	38.7 pc/mi/ln	E	0.933
				PM	3330	21.4 pc/mi/ln	C	0.558
I-471 Merge	Gilbert Merge	NB	3	AM	7530	-	F	1.255
				PM	4440	28.4 pc/mi/ln	D	0.740
North of I-471 Diverge		SB	3	AM	5230	34.7 pc/mi/ln	D	0.872
				PM	6490	-	F	1.082
I-471 Diverge	3rd Street Diverge	SB	3	AM	4580	29.5 pc/mi/ln	D	0.767
				PM	4960	32.4 pc/mi/ln	D	0.831
3rd Street Diverge	US 50 Merge	SB	2	AM	3120	30.2 pc/mi/ln	D	0.784
				PM	4490	-	F	1.128
US 50 Merge	I-75 NB/US 50 Diverge	SB	4	AM	5440	26.5 pc/mi/ln	D	0.690
				PM	6460	31.9 pc/mi/ln	D	0.819
I-75 NB/US 50 Diverge	I-75 SB Merge	SB	2	AM	2310	22.5 pc/mi/ln	C	0.586
				PM	3170	31.9 pc/mi/ln	D	0.819

Alternative B US 50 Freeway Segments								
Freeway Segment		Direction	Number of Lanes	Peak	Volume	Density	LOS	Volume/Capacity
From	To							
West of Freeman Avenue Diverge		EB	3	AM	3370	21.3 pc/mi/ln	C	0.556
				PM	1220	7.7 pc/mi/ln	A	0.201
Freeman Avenue Diverge	Freeman Avenue Merge	EB	2	AM	2870	27.2 pc/mi/ln	D	0.710
				PM	1100	10.4 pc/mi/ln	A	0.272
Freeman Avenue Merge	W 6th Street Merge	EB	3	AM	2920	24.32 pc/mi/ln*	C	0.636
				PM	1460	11.17 pc/mi/ln*	B	0.339
W 6th Street Merge	I-75 SB Diverge	EB	3	AM	3140	28.12 pc/mi/ln*	D	0.719
				PM	2220	19.62 pc/mi/ln*	B	0.541
I-75 SB Diverge	I-71/W 2nd Split	EB	2	AM	1950	18.3 pc/mi/ln	C	0.478
				PM	1230	11.6 pc/mi/ln	B	0.303
I-75 NB Merge	I-71 SB Merge	WB	3	AM	940	5.9 pc/mi/ln	A	0.154
				PM	1460	9.2 pc/mi/ln	A	0.240
I-71 SB Merge	Gest Street Diverge	WB	4	AM	1930	11.90 pc/mi/ln*	B	0.366
				PM	3030	20.81 pc/mi/ln*	C	0.577
Gest Street Diverge	Linn Street Diverge	WB	4	AM	1420	7.27 pc/mi/ln*	A	0.232
				PM	2680	15.02 pc/mi/ln*	B	0.433
Linn Street Diverge	Freeman Avenue Merge	WB	3	AM	880	5.6 pc/mi/ln	A	0.145
				PM	2420	15.3 pc/mi/ln	B	0.399
West of Freeman Avenue Merge		WB	3	AM	1050	6.7 pc/mi/ln	A	0.173
				PM	2880	18.2 pc/mi/ln	C	0.475

Alternative B I-71/I75 Connector Freeway Segments								
Freeway Segment		Direction	Number of Lanes	Peak	Volume	Density	LOS	Volume/Capacity
From	To							
I-75 NB Split	W 12th Diverge	NB	2	AM	2840	27.0 pc/mi/ln	D	0.703
				PM	2010	19.1 pc/mi/ln	C	0.498
W 12th Diverge	W 9th Merge	NB	2	AM	1700	16.1 pc/mi/ln	B	0.421
				PM	810	7.7 pc/mi/ln	A	0.200
W 9th Merge	W 2nd Diverge	NB	3	AM	3440	21.8 pc/mi/ln	C	0.568
				PM	2010	12.7 pc/mi/ln	B	0.332
W 2nd Diverge	Connector Split	NB	3	AM	2240	14.2 pc/mi/ln	B	0.370
				PM	1580	10.0 pc/mi/ln	A	0.261
Connector Split	Connector Converge (west)	NB	1	AM	650	12.3 pc/mi/ln	B	0.322
				PM	390	7.4 pc/mi/ln	A	0.193
Connector Split	US 50 Diverge	NB	2	AM	1590	15.1 pc/mi/ln	B	0.394
				PM	1190	11.3 pc/mi/ln	B	0.295
US 50 Diverge	W 5th Diverge	NB	1	AM	1430	27.0 pc/mi/ln	D	0.705
				PM	1110	20.9 pc/mi/ln	C	0.544
US 50 Diverge	I-71 SB Merge	NB	1	AM	160	3.0 pc/mi/ln	A	0.080
				PM	80	1.5 pc/mi/ln	A	0.040

\* Indicates Weave Segments

## Alternative B Traffic Data - Freeway Segments

*Data Corresponds With Level of Service Exhibits*

Alternative B I-71/I-75 Connector Freeway Segments								
Freeway Segment		Direction	Number of Lanes	Peak	Volume	Density	LOS	Volume/Capacity
From	To							
I-71 SB Merge	W 4th Merge	NB	2	AM	2110	20.1 pc/mi/ln	C	0.525
				PM	1480	13.9 pc/mi/ln	B	0.363
W 4th Merge	NB Connector Converge	NB	3	AM	2540	16.1 pc/mi/ln	B	0.421
				PM	3900	24.4 pc/mi/ln	C	0.638
I-71 SB Diverge	Local SB Ramps Diverge	NB	2	AM	2940	30.2 pc/mi/ln	D	0.735
				PM	3290	31.6 pc/mi/ln	D	0.814
Local SB Ramps Diverge	US 50 Diverge	NB	2	AM	2940	28.2 pc/mi/ln	D	0.735
				PM	2970	28.2 pc/mi/ln	D	0.735
US 50 Diverge	NB Connector Merge	NB	1	AM	1950	42.0 pc/mi/ln*	E	0.970
				PM	1400	26.3 pc/mi/ln	D	0.687
NB Connector Converge	I-75 NB Merge	NB	3	AM	3190	20.3 pc/mi/ln	C	0.529
				PM	4290	26.9 pc/mi/ln	D	0.701
I-75 SB Diverge	WHV merge	SB	3	AM	4480	28.5 pc/mi/ln	D	0.743
				PM	3540	22.4 pc/mi/ln	C	0.584
WHV merge	Local SB Ramps Diverge	SB	4	AM	5840	39.85 pc/mi/ln*	E	0.942
				PM	4310	31.64 pc/mi/ln*	D	0.719
Local SB Ramps Diverge	W 7th Diverge	SB	3	AM	4970	31.9 pc/mi/ln	D	0.820
				PM	2420	15.3 pc/mi/ln	B	0.399
W 7th Diverge	W 5th Diverge	SB	3	AM	3410	22.5 pc/mi/ln	C	0.563
				PM	1580	14.1 pc/mi/ln	B	0.261
W 5th Diverge	I-71 NB/W 2nd Split	SB	2	AM	2000	27.3 pc/mi/ln	D	0.495
				PM	1390	19.5 pc/mi/ln	C	0.344
W 2nd Split	US 50 Merge	SB	1	AM	1320	25.3 pc/mi/ln	C	0.660
				PM	1220	23.0 pc/mi/ln	C	0.601
US 50 Merge	I-71 NB Merge	SB	2	AM	3010	28.6 pc/mi/ln	D	0.745
				PM	2360	22.3 pc/mi/ln	C	0.582
I-71 NB Split	US 50 Merge	SB	1	AM	1560	29.1 pc/mi/ln	D	0.757
				PM	840	15.7 pc/mi/ln	B	0.410
US 50 Merge	I-75 NB Merge	SB	2	AM	1820	16.9 pc/mi/ln	B	0.442
				PM	930	8.7 pc/mi/ln	A	0.227
SB Connector Diverge	Freeman Diverge	SB	1	AM	870	16.5 pc/mi/ln	B	0.431
				PM	1890	39.0 pc/mi/ln	E	0.936
Freeman Diverge	Ezzard Charles Merge	SB	1	AM	100	1.9 pc/mi/ln	A	0.050
				PM	1370	26.0 pc/mi/ln	C	0.678
Ezzard Charles Merge	W 9th Merge	SB	1	AM	200	3.8 pc/mi/ln	A	0.099
				PM	1570	29.9 pc/mi/ln	D	0.777
W 9th Merge	US 50 Merge	SB	1	AM	270	5.1 pc/mi/ln	A	0.134
				PM	2070	-	F	1.025
US 50 Merge	I-71 SB Merge	SB	1	AM	940	18.1 pc/mi/ln	C	0.472
				PM	2890	-	F	1.431
I-71 SB Merge	W 9th Diverge (KY)	SB	2	AM	1410	13.7 pc/mi/ln	B	0.358
				PM	4660	-	F	1.153
W 9th Diverge (KY)	I-75 SB Merge	SB	1	AM	330	6.5 pc/mi/ln	A	0.171
				PM	3030	-	F	1.537

\* Indicates Weave Segments



### Alternative B Traffic Data - Intersections

*Data Corresponds With Level of Service Exhibits*

HCS Results - Signalized Intersections - 2035 Alternative B Volumes												
ID	Intersection	Peak	Eastbound		Westbound		Northbound		Southbound		Overall	
			Delay	LOS	Delay	LOS	Delay	LOS	Delay	LOS	Delay	LOS
OH-1	Bank Street & Dalton Avenue	AM	18.6s	B	21.6s	C	19.7s	B	21.5s	C	20.8s	C
		PM	21.1s	C	31.6s	C	19.7s	B	29.7s	C	26.6s	C
OH-2	Bank Street & Winchell Avenue	AM	11.3s	B	10.7s	B	11.5s	B	N/A	N/A	11.4s	B
		PM	13.1s	B	11.5s	B	12.8s	B	N/A	N/A	12.6s	B
OH-3	Central Pkwy & Linn Street	AM	85.1s	F	9.0s	A	19.9s	B	92.5s	F	63.2s	E
		PM	13.1s	B	214.3s	F	27.2s	C	223.0s	F	145.4s	F
OH-5	Findlay Street & Dalton Avenue	AM	17.5s	B	18.3s	B	18.2s	B	10.8s	B	14.5s	B
		PM	19.0s	B	20.1s	C	19.7s	B	10.6s	B	15.9s	B
OH-6	Findlay Street & Western Avenue	AM	13.5s	B	13.3s	B	N/A	N/A	13.3s	B	13.4s	B
		PM	13.7s	B	13.4s	B	N/A	N/A	13.4s	B	13.5s	B
OH-7	Findlay Street & Winchell Avenue	AM	14.2s	B	13.1s	B	14.1s	B	N/A	N/A	14.1s	B
		PM	15.0s	B	14.0s	B	14.7s	B	N/A	N/A	14.7s	B
OH-8	Liberty Street & Dalton Avenue	AM	11.5s	B	12.5s	B	11.4s	B	12.0s	B	11.8s	B
		PM	12.0s	B	13.7s	B	11.2s	B	14.2s	B	13.2s	B
OH-9	Liberty Street & Western Avenue	AM	11.2s	B	10.7s	B	N/A	N/A	11.1s	B	11.0s	B
		PM	11.1s	B	10.8s	B	N/A	N/A	11.1s	B	11.0s	B
OH-10	Liberty Street & Winchell Avenue	AM	11.9s	B	10.9s	B	12.0s	B	N/A	N/A	11.8s	B
		PM	12.1s	B	12.4s	B	12.2s	B	N/A	N/A	12.3s	B
OH-11	Liberty Street & Linn Street	AM	12.6s	B	12.4s	B	12.7s	B	12.5s	B	12.5s	B
		PM	12.0s	B	13.5s	B	13.2s	B	12.7s	B	13.0s	B
OH-12	Ezzard Charles WB & Western Avenue	AM	N/A	N/A	19.2s	B	N/A	N/A	18.9s	B	19.0s	B
		PM	N/A	N/A	18.6s	B	N/A	N/A	18.7s	B	18.7s	B
OH-13	Ezzard Charles WB & Winchell Avenue	AM	N/A	N/A	10.9s	B	11.1s	B	N/A	N/A	11.0s	B
		PM	N/A	N/A	12.0s	B	12.2s	B	N/A	N/A	12.1s	B
OH-14	Ezzard Charles EB & Western Avenue	AM	18.6s	B	N/A	N/A	N/A	N/A	18.3s	B	18.4s	B
		PM	18.7s	B	N/A	N/A	N/A	N/A	18.5s	B	18.5s	B
OH-15	Ezzard Charles EB & Winchell Avenue	AM	11.6s	B	N/A	N/A	11.5s	B	N/A	N/A	11.5s	B
		PM	11.2s	B	N/A	N/A	11.5s	B	N/A	N/A	11.5s	B
OH-16	Ezzard Charles & Linn Street	AM	13.0s	B	11.6s	B	13.3s	B	13.0s	B	12.9s	B
		PM	12.8s	B	13.3s	B	13.1s	B	13.0s	B	13.1s	B
OH-17	Gest Street & Dalton Avenue	AM	15.2s	B	15.8s	B	15.8s	B	16.0s	B	15.7s	B
		PM	16.8s	B	17.0s	B	13.7s	B	16.8s	B	16.2s	B
OH-18	Gest Street & Western Avenue	AM	15.0s	B	15.4s	B	N/A	N/A	15.1s	B	15.2s	B
		PM	15.0s	B	14.5s	B	N/A	N/A	14.9s	B	14.8s	B
OH-19	Gest Street & Freeman Avenue	AM	17.4s	B	26.8s	C	21.3s	C	26.3s	C	23.9s	C
		PM	15.4s	B	23.5s	C	22.3s	C	23.3s	C	21.2s	C
OH-20	Linn/W 3rd Street & Gest Street	AM	15.2s	B	17.1s	B	17.2s	B	9.9s	A	15.4s	B
		PM	16.7s	B	17.9s	B	18.0s	B	10.3s	B	16.5s	B
OH-23	8th Street & Dalton Avenue	AM	12.9s	B	19.4s	B	18.3s	B	19.2s	B	16.4s	B
		PM	12.2s	B	21.1s	C	18.1s	B	20.8s	C	19.1s	B
OH-24	8th Street & Freeman Avenue	AM	24.4s	C	21.3s	C	24.3s	C	21.2s	C	23.3s	C
		PM	22.9s	C	23.0s	C	22.2s	C	23.2s	C	23.0s	C
OH-25	8th Street & Linn Street	AM	21.6s	C	19.3s	B	20.9s	C	21.5s	C	21.2s	C
		PM	23.3s	C	24.0s	C	24.5s	C	20.4s	C	23.1s	C
OH-26	WHV & Spring Grove Avenue	AM	28.1s	C	26.0s	C	16.5s	B	28.8s	C	25.6s	C
		PM	18.6s	B	47.0s	D	32.5s	C	48.9s	D	38.1s	D
OH-27	Dalton Avenue & Linn Street	AM	13.5s	B	14.7s	B	14.8s	B	14.1s	B	14.4s	B
		PM	17.8s	B	10.8s	B	18.0s	B	18.0s	B	16.8s	B
OH-29	W Court Street & Central Avenue	AM	15.7s	B	13.4s	B	15.8s	B	N/A	N/A	15.4s	B
		PM	12.8s	B	13.6s	B	13.5s	B	N/A	N/A	13.4s	B
OH-30	W 9th Street & Central Avenue	AM	N/A	N/A	12.5s	B	12.7s	B	12.2s	B	12.6s	B
		PM	N/A	N/A	13.7s	B	13.8s	B	13.9s	B	13.7s	B
OH-31	W 7th Street & Central Avenue	AM	16.4s	B	N/A	N/A	16.2s	B	N/A	N/A	16.4s	B
		PM	13.2s	B	N/A	N/A	13.5s	B	N/A	N/A	13.3s	B
OH-32	W 6th Street & Central Avenue	AM	N/A	N/A	13.9s	B	13.7s	B	N/A	N/A	13.8s	B
		PM	N/A	N/A	14.0s	B	14.2s	B	N/A	N/A	14.1s	B

### Alternative B Traffic Data - Intersections

*Data Corresponds With Level of Service Exhibits*

HCS Results - Signalized Intersections - 2035 Alternative B Volumes												
ID	Intersection	Peak	Eastbound		Westbound		Northbound		Southbound		Overall	
			Delay	LOS	Delay	LOS	Delay	LOS	Delay	LOS	Delay	LOS
OH-33	W 5th Street & Central Avenue	AM	68.6s	E	N/A	N/A	65.8s	E	10.0s	B	65.6s	E
		PM	31.4s	C	N/A	N/A	31.3s	C	5.5s	A	28.4s	C
OH-34	W 4th Street & Central Avenue	AM	N/A	N/A	18.6s	B	17.8s	B	18.4s	B	18.2s	B
		PM	N/A	N/A	115.2s	F	113.8s	F	112.8s	F	114.2s	F
OH-35	W 3rd Street & Central Avenue	AM	43.9s	D	43.2s	D	37.8s	D	44.1s	D	43.4s	D
		PM	116.9s	F	113.6s	F	107.6s	F	112.7s	F	112.3s	F
OH-36	W 4th Street & Plum Street	AM	N/A	N/A	12.7s	B	N/A	N/A	12.9s	B	12.8s	B
		PM	N/A	N/A	14.8s	B	N/A	N/A	14.7s	B	14.8s	B
OH-37	W 3rd Street & Plum Street	AM	N/A	N/A	13.5s	B	N/A	N/A	13.5s	B	13.5s	B
		PM	N/A	N/A	14.1s	B	N/A	N/A	14.1s	B	14.1s	B
OH-38	W 4th Street & Elm Street	AM	N/A	N/A	14.0s	B	13.8s	B	N/A	N/A	13.9s	B
		PM	N/A	N/A	15.4s	B	15.8s	B	N/A	N/A	15.5s	B
OH-39	W 3rd Street & Elm Street	AM	N/A	N/A	14.5s	B	14.6s	B	N/A	N/A	14.6s	B
		PM	N/A	N/A	16.6s	B	17.0s	B	N/A	N/A	16.7s	B
OH-40	W 2nd Street & Elm Street	AM	17.4s	B	N/A	N/A	17.8s	B	N/A	N/A	17.5s	B
		PM	16.4s	B	N/A	N/A	16.7s	B	N/A	N/A	16.5s	B
OH-41	W 3rd Street & Clay Wade Bailey Bridge	AM	17.9s	B	18.0s	B	18.0s	B	N/A	N/A	18.0s	B
		PM	24.5s	C	25.4s	C	25.5s	C	N/A	N/A	25.1s	C
OH-42	WHV & I-75 NB Ramps	AM	24.5s	C	N/A	N/A	24.7s	C	N/A	N/A	24.6s	C
		PM	22.4s	C	N/A	N/A	21.8s	C	N/A	N/A	22.0s	C
OH-43	W McMillan Street & Central Pkwy	AM	32.1s	C	21.7s	C	17.1s	B	33.1s	C	29.0s	C
		PM	20.0s	B	78.7s	E	81.0s	F	39.5s	D	61.7s	E
OH-44	W McMillan Street & W McMicken Avenue	AM	17.1s	B	7.1s	A	16.2s	B	17.4s	B	15.4s	B
		PM	16.7s	B	9.3s	A	15.0s	B	17.0s	B	13.3s	B
OH-47	W McMillan Street/Fairview Avenue/Ravine Street	AM	See Below									
		PM	See Below									
OH-50	I-75 NB Ramps & Central Pkwy	AM	39.5s	D	N/A	N/A	34.4s	C	39.4s	D	38.0s	D
		PM	22.2s	C	N/A	N/A	18.4s	B	22.5s	C	20.2s	C
OH-51	WHV & I-75 SB Ramps	AM	53.2s	D	16.0s	B	N/A	N/A	53.0s	D	49.2s	D
		PM	16.8s	B	19.8s	B	N/A	N/A	19.5s	B	18.8s	B
KY-2	W 4th Street & Philadelphia Street	AM	N/A	N/A	16.1s	B	13.8s	B	15.8s	B	15.4s	B
		PM	N/A	N/A	18.3s	B	15.6s	B	18.2s	B	17.6s	B
KY-3	W 4th Street & Bakewell Street	AM	N/A	N/A	13.6s	B	13.2s	B	13.9s	B	13.6s	B
		PM	N/A	N/A	14.3s	B	14.7s	B	14.7s	B	14.4s	B
KY-4	W 4th Street & Main Street	AM	N/A	N/A	14.7s	B	15.1s	B	11.6s	B	14.1s	B
		PM	N/A	N/A	30.0s	C	6.5s	A	31.5s	C	28.8s	C
KY-7	W 5th Street & Philadelphia Street	AM	18.0s	B	N/A	N/A	17.6s	B	18.0s	B	18.0s	B
		PM	17.8s	B	N/A	N/A	16.6s	B	17.8s	B	17.7s	B
KY-9	W 5th Street & Main Street	AM	16.2s	B	N/A	N/A	16.7s	B	16.4s	B	16.3s	B
		PM	42.2s	D	N/A	N/A	8.2s	A	43.8s	D	40.3s	D
KY-10	Pike Street & Bullock Street	AM	28.6s	C	23.2s	C	N/A	N/A	28.7s	C	27.7s	C
		PM	47.2s	D	40.6s	D	N/A	N/A	47.4s	D	45.0s	D
KY-11	Pike Street & Jillians Way	AM	363.0s	F	6.9s	A	359.6s	F	N/A	N/A	280.0s	F
		PM	103.9s	F	10.0s	A	106.2s	F	N/A	N/A	66.0s	E
KY-14	Dixie Hwy & Kyles Lane	AM	140.3s	F	157.3s	F	148.8s	F	28.5s	C	145.5s	F
		PM	108.0s	F	102.4s	F	106.5s	F	21.0s	C	103.8s	F
KY-15	I-75 SB Ramps & Kyles Lane	AM	N/A	N/A	23.3s	C	14.6s	B	23.6s	C	20.3s	C
		PM	N/A	N/A	67.7s	E	28.2s	C	69.2s	E	54.2s	D
KY-16	I-75 NB Ramps & Kyles Lane	AM	141.0s	F	N/A	N/A	143.5s	F	5.8s	A	95.3s	F
		PM	29.8s	C	N/A	N/A	31.1s	C	15.5s	B	24.3s	C
KY-17	Highland Avenue & Kyles Lane	AM	186.5s	F	20.0s (-)	B	175.9s	F	27.4s	C	134.1s	F
		PM	88.1s	F	224.8s	F	211.4s	F	37.3s	D	167.2s	F
KY-18	I-75 SB Ramps & Dixie Hwy	AM	N/A	N/A	18.0s	B	17.6s	B	17.6s	B	17.7s	B
		PM	N/A	N/A	25.1s	C	8.1s	A	24.4s	C	19.9s	B
KY-19	I-75 NB Ramps & Dixie Hwy	AM	27.1s	C	N/A	N/A	26.3s	C	9.2s	A	21.9s	C
		PM	18.7s	B	N/A	N/A	18.7s	B	14.7s	B	16.4s	B
KY-A	W 9th & Jillians Way	AM	34.1s	C	33.5s	C	34.4s	C	N/A	N/A	34.1s	C
		PM	33.3s	C	32.5s	C	33.1s	C	N/A	N/A	32.9s	C

### Alternative B Traffic Data - Intersections

*Data Corresponds With Level of Service Exhibits*

HCS Results - Signalized Intersections - 2035 Alternative B Volumes												
ID	Intersection	Peak	Eastbound		Westbound		Northbound		Southbound		Overall	
			Delay	LOS	Delay	LOS	Delay	LOS	Delay	LOS	Delay	LOS
KY-B	W 9th & Bullock St	AM	44.0s	D	44.6s	D	N/A	N/A	43.1s	D	43.4s	D
		PM	48.7s	D	62.4s	E	N/A	N/A	62.5s	E	62.1s	E
KY-C	W 5h & Jillians Way	AM	18.9s	B	N/A	N/A	19.3	B	N/A	N/A	19.3s	B
		PM	17.9s	B	N/A	N/A	17.3s	B	N/A	N/A	17.4s	B
KY-D	W 5th & Local CD SB (Bullock St)	AM	15.6s	B	N/A	N/A	N/A	N/A	15.5s	B	15.6s	B
		PM	16.0s	B	N/A	N/A	N/A	N/A	15.8s	B	15.9s	B
KY-E	W 4th & I-75 NB Ramps	AM	N/A	N/A	15.0s	B	14.8s	B	N/A	N/A	15.0s	B
		PM	N/A	N/A	17.6s	B	17.8s	B	N/A	N/A	17.7s	B

ID	Intersection	Peak	Eastbound		Westbound		Northbound		Southbound		Northeastbound	
			Delay	LOS	Delay	LOS	Delay	LOS	Delay	LOS	Delay	LOS
OH-47	W McMillan Street/Fairview Avenue/Ravine Street	AM	18.6s	B	12.5s	B	33.4s	C	25.8s	C	36.2s	D
		PM	20.9s	C	25.0s	C	29.9s	C	19.7s	B	34.2s	C
			Southwestbound		Overall							
			Delay	LOS	Delay	LOS						
			34.8s	C	20.6s	C						
			40.0s	D	26.8s	C						

HCS Results - Unsignalized Intersections - 2035 Alternative B Volumes												
ID	Intersection	Peak	Eastbound		Westbound		Northbound		Southbound		Overall	
			Delay	LOS	Delay	LOS	Delay	LOS	Delay	LOS	Delay	LOS
OH-4	Bank Street & Linn Street	AM	12.5s	B	N/A	N/A	7.8s [L]	A	N/A	N/A	N/A	N/A
		PM	20.8s	C	N/A	N/A	8.4s [L]	A	N/A	N/A	N/A	N/A
OH-21	Court Street & Linn Street	AM	13.4s	B	14.8s	B	7.9s [L]	A	8.4s [L]	A	N/A	N/A
		PM	22.6s	C	32.0s	D	9.0s [L]	A	8.9s [L]	A	N/A	N/A
OH-28	W 6th Street & Linn Street	AM	N/A	N/A	N/A	N/A	N/A	N/A	8.5s [L]	A	N/A	N/A
		PM	N/A	N/A	N/A	N/A	N/A	N/A	14.3s [L]	B	N/A	N/A
OH-45	Clemmer Avenue & W McMillan Street	AM	N/A	N/A	14.0s	B	N/A	N/A	7.8s [L]	A	N/A	N/A
		PM	N/A	N/A	20.4s	C	N/A	N/A	9.4s [L]	A	N/A	N/A
OH-46	W McMillan Street & Scenic Drive	AM	N/A	N/A	N/A	N/A	9.7s [L]	A	N/A	N/A	N/A	N/A
		PM	N/A	N/A	N/A	N/A	8.3s [L]	A	N/A	N/A	N/A	N/A
OH-48	W McMillan Street & Flora Avenue	AM	N/A	N/A	9.4s [L]	A	10.8s	B	N/A	N/A	N/A	N/A
		PM	N/A	N/A	8.5s [L]	A	9.9s	A	N/A	N/A	N/A	N/A
OH-49	W McMillan Street & Victor Avenue	AM	N/A	N/A	9.5s [L]	A	15.1s	C	N/A	N/A	N/A	N/A
		PM	N/A	N/A	8.5s [L]	A	13.7s	B	N/A	N/A	N/A	N/A
KY-1	W 4th Street & Crescent Avenue	AM	N/A	N/A	10.5s	B	N/A	N/A	N/A	N/A	N/A	N/A
		PM	N/A	N/A	11.9s	B	N/A	N/A	N/A	N/A	N/A	N/A
KY-6	W 5th Street & Crescent Avenue	AM	N/A	N/A	N/A	N/A	N/A	N/A	9.0s [L]	A	N/A	N/A
		PM	N/A	N/A	N/A	N/A	N/A	N/A	8.3s [L]	A	N/A	N/A
KY-8	W 5th Street & Bakewell Street	AM	7.3s [L]	A	N/A	N/A	25.4s	D	41.3s	E	N/A	N/A
		PM	7.3s [L]	A	N/A	N/A	27.4s	D	31.9s	D	N/A	N/A
KY-12	W 12th Street & Bullock Street	AM	15.45s	C	25.03s	D	N/A	N/A	49.32s	E	38.70s	E
		PM	11.48s	B	39.98s	E	N/A	N/A	352.38s	F	270.29s	F
KY-13	W 12th Street & Jillians Way	AM	156.84s	F	268.17s	F	699.74s	F	N/A	N/A	444.89s	F
		PM	112.66s	F	250.19s	F	693.74s	F	N/A	N/A	440.6s	F

## Alternative B Traffic Data - Ramp Segments

*Data Corresponds With Level of Service Exhibits*

Alternative B I-75 Ramp Junctions					
Ramp Junction	Direction	Ramp Volumes	Peak	Density	LOS
Dixie Highway Diverge	NB	720	AM	-	F
		1100	PM	-	F
Dixie Highway/Kyles Lane Split	NB	280	AM	14.9 pc/mi/l <sub>n</sub>	B
		380	PM	22.7 pc/mi/l <sub>n</sub>	C
Dixie Highway Merge	NB	1000	AM	-	F
		380	PM	-	F
Kyles Lane Merge	NB	1470	AM	29.1 pc/mi/l <sub>n</sub>	D
		710	PM	29.8 pc/mi/l <sub>n</sub>	D
Local CD Diverge	NB	2840	AM	29.5 pc/mi/l <sub>n</sub>	D
		2010	PM	30.9 pc/mi/l <sub>n</sub>	D
W 5th Merge	NB	850	AM	29.2 pc/mi/l <sub>n</sub>	D
		400	PM	26.4 pc/mi/l <sub>n</sub>	C
I-71 NB/I-75 NB Split	NB	4470	AM	-	F
		2660	PM	-	F
I-71 SB/Local CD Merge	NB	3190	AM	23.7 pc/mi/l <sub>n</sub>	C
		4290	PM	-	F
Central Pkwy/WHV diverge	NB	1570	AM	28.9 pc/mi/l <sub>n</sub>	D
		950	PM	33.5 pc/mi/l <sub>n</sub>	D
Central Pkwy/WHV Ramp Split	NB	650	AM	32.3 pc/mi/l <sub>n</sub>	D
		190	PM	19.4 pc/mi/l <sub>n</sub>	C
WHV/Bank Ramps Merge	NB	310	AM	19.0 pc/mi/l <sub>n</sub>	C
		870	PM	15.5 pc/mi/l <sub>n</sub>	B
Bank/WHV Merge	NB	1570	AM	32.3 pc/mi/l <sub>n</sub>	D
		1220	PM	28.6 pc/mi/l <sub>n</sub>	D
Central Pkwy Merge	NB	510	AM	17.4 pc/mi/l <sub>n</sub>	B
		230	PM	20.3 pc/mi/l <sub>n</sub>	C
WHV Diverge	SB	1110	AM	43.3 pc/mi/l <sub>n</sub>	E
		510	PM	30.6 pc/mi/l <sub>n</sub>	D
Findlay Diverge	SB	270	AM	27.1 pc/mi/l <sub>n</sub>	C
		450	PM	21.3 pc/mi/l <sub>n</sub>	C
I-71 NB/Local CD Diverge	SB	4480	AM	44.4 pc/mi/l <sub>n</sub>	E
		3540	PM	26.5 pc/mi/l <sub>n</sub>	D
I-71 SB Merge	SB	2310	AM	44.4 pc/mi/l <sub>n</sub>	E
		3170	PM	31.9 pc/mi/l <sub>n</sub>	D
Local CD Merge	SB	330	AM	30.5 pc/mi/l <sub>n</sub>	D
		3030	PM	-	F
W 12th Merge	SB	780	AM	26.0 pc/mi/l <sub>n</sub>	C
		1460	PM	37.7 pc/mi/l <sub>n</sub>	E
Kyles Lane Diverge	SB	880	AM	33.0 pc/mi/l <sub>n</sub>	D
		1820	PM	-	F
Kyles/Dixie Split	SB	690	AM	18.4 pc/mi/l <sub>n</sub>	C
		1140	PM	38.8 pc/mi/l <sub>n</sub>	E
Kyles/Dixie Merge	SB	350	AM	11.1 pc/mi/l <sub>n</sub>	B
		560	PM	25.3 pc/mi/l <sub>n</sub>	C
Kyles CD/Dixie exit split	SB	190	AM	11.1 pc/mi/l <sub>n</sub>	B
		680	PM	25.3 pc/mi/l <sub>n</sub>	C
Kyles CD merge	SB	350	AM	33.0 pc/mi/l <sub>n</sub>	D
		560	PM	-	F
Dixie Merge	SB	340	AM	21.2 pc/mi/l <sub>n</sub>	C
		630	PM	31.4 pc/mi/l <sub>n</sub>	D

## Alternative B Traffic Data - Ramp Segments

*Data Corresponds With Level of Service Exhibits*

Alternative B I-71 Ramp Junctions					
Ramp Junction	Direction	Ramp Volumes	Peak	Density	LOS
US 50/I-75 SB Merge	NB	3010	AM	-	F
		2360	PM	26.0 pc/mi/l <sub>n</sub>	C
US 50 Diverge	NB	2160	AM	-	F
		2510	PM	24.4 pc/mi/l <sub>n</sub>	C
W 2nd Merge	NB	60	AM	-	F
		290	PM	24.2 pc/mi/l <sub>n</sub>	C
W 5th Merge	NB	190	AM	32.6 pc/mi/l <sub>n</sub>	D
		530	PM	21.7 pc/mi/l <sub>n</sub>	C
I-471 Merge	NB	1960	AM	-	F
		1110	PM	29.3 pc/mi/l <sub>n</sub>	D
I-471 Diverge	SB	650	AM	32.3 pc/mi/l <sub>n</sub>	D
		1530	PM	-	F
W 3rd Street Diverge	SB	1460	AM	30.4 pc/mi/l <sub>n</sub>	D
		470	PM	-	F
US 50 Merge	SB	2320	AM	30.2 pc/mi/l <sub>n</sub>	D
		1970	PM	-	F
US 50 WB/I-75 NB diverge	SB	2940	AM	30.2 pc/mi/l <sub>n</sub>	D
		2970	PM	31.9 pc/mi/l <sub>n</sub>	D

Alternative B US 50 Ramp Junctions					
Ramp Junction	Direction	Ramp Volumes	Peak	Density	LOS
Freeman Avenue Diverge	EB	500	AM	27.2 pc/mi/l <sub>n</sub>	D
		120	PM	10.4 pc/mi/l <sub>n</sub>	A
W 2nd Diverge	EB	260	AM	34.8 pc/mi/l <sub>n</sub>	D
		90	PM	23.5 pc/mi/l <sub>n</sub>	C
I-75 NB Merge	WB	850	AM	17.5 pc/mi/l <sub>n</sub>	B
		830	PM	17.0 pc/mi/l <sub>n</sub>	B
Freeman Avenue Merge	WB	170	AM	6.7 pc/mi/l <sub>n</sub>	A
		460	PM	17.2 pc/mi/l <sub>n</sub>	B

Alternative B I-71/I-75 Connector Ramp Junctions					
Ramp Junction	Direction	Ramp Volumes	Peak	Density	LOS
W 12th Diverge	NB	1140	AM	30.3 pc/mi/l <sub>n</sub>	D
		1200	PM	22.1 pc/mi/l <sub>n</sub>	C
W 9th Merge (KY)	NB	1740	AM	36.5 pc/mi/l <sub>n</sub>	E
		1200	PM	24.7 pc/mi/l <sub>n</sub>	C
W 2nd Diverge (OH)	NB	1200	AM	27.3 pc/mi/l <sub>n</sub>	C
		430	PM	17.2 pc/mi/l <sub>n</sub>	B
Connector Split	NB	650	AM	15.1 pc/mi/l <sub>n</sub>	B
		390	PM	11.3 pc/mi/l <sub>n</sub>	B
US 50 Diverge	NB	1430	AM	27.0 pc/mi/l <sub>n</sub>	D
		1110	PM	20.9 pc/mi/l <sub>n</sub>	C
W 5th Diverge (OH)	NB	580	AM	27.0 pc/mi/l <sub>n</sub>	D
		280	PM	20.9 pc/mi/l <sub>n</sub>	C
US 50/I-71 SB Split	NB	990	AM	42.0 pc/mi/l <sub>n</sub>	E
		1570	PM	30.1 pc/mi/l <sub>n</sub>	D
I-71 SB Merge	NB	1950	AM	42.0 pc/mi/l <sub>n</sub>	E
		1400	PM	26.3 pc/mi/l <sub>n</sub>	D
W 4th Merge (OH)	NB	430	AM	20.1 pc/mi/l <sub>n</sub>	C
		2420	PM	-	F
Connector Converge	NB	650	AM	16.1 pc/mi/l <sub>n</sub>	B
		390	PM	24.4 pc/mi/l <sub>n</sub>	C

## Alternative B Traffic Data - Ramp Segments

*Data Corresponds With Level of Service Exhibits*

Alternative B I-71/I-75 Connector Ramp Junctions					
Ramp Junction	Direction	Ramp Volumes	Peak	Density	LOS
W 7th Diverge	SB	1410	AM	35.3 pc/mi/ln	E
		190	PM	19.2 pc/mi/ln	B
W 5th Diverge (OH)	SB	680	AM	27.3 pc/mi/ln	D
		170	PM	19.5 pc/mi/ln	C
W 2nd/I-71 NB Split	SB	1560	AM	29.1 pc/mi/ln	D
		840	PM	27.3 pc/mi/ln	D
I-71 NB/US 50 EB ramp Merge	SB	1690	AM	34.8 pc/mi/ln	D
		1140	PM	23.5 pc/mi/ln	C
W 2nd/US 50 EB ramp Merge	SB	260	AM	29.1 pc/mi/ln	D
		90	PM	15.7 pc/mi/ln	B
Freeman Diverge	SB	770	AM	16.6 pc/mi/ln	B
		520	PM	39.0 pc/mi/ln	E
Ezzard Charles Merge	SB	100	AM	3.8 pc/mi/ln	A
		200	PM	29.9 pc/mi/ln	D
W 9th Merge (OH)	SB	70	AM	5.1 pc/mi/ln	A
		500	PM	-	F
US 50 EB Merge	SB	670	AM	18.1 pc/mi/ln	C
		820	PM	-	F
I-71 SB/W 3rd merge	SB	280	AM	9.2 pc/mi/ln	A
		1450	PM	35.2 pc/mi/ln	E
I-71 SB Merge	SB	470	AM	18.1 pc/mi/ln	C
		1770	PM	-	F
W 9th Diverge (KY)	SB	1080	AM	22.4 pc/mi/ln	C
		1630	PM	-	F

## Alternative C Traffic Data - Freeway Segments

*Data Corresponds With Level of Service Exhibits*

Alternative C I-75 Freeway Segments								
Freeway Segment		Number of Lanes	Direction	Peak	Volume	Density	LOS	Volume/ Capacity
From	To							
South of Dixie Highway	Dixie Highway Diverge	3	NB	AM	7160	-	F	1.216
				PM	8280	-	F	1.413
Dixie Highway Diverge	Dixie Highway Merge	3	NB	AM	6440	-	F	1.094
				PM	7180	-	F	1.225
Dixie Highway Merge	Kyles Lane Merge	5	NB	AM	7440	29.1 pc/mi/ln	D	0.758
				PM	7560	29.8 pc/mi/ln	D	0.774
Kyles Lane Merge	W 12th/W 5th Diverge	6	NB	AM	8910	29.1 pc/mi/ln	D	0.757
				PM	8270	27.1 pc/mi/ln	D	0.706
W 12th/W 5th Diverge	I-71 Diverge	4	NB	AM	6070	29.5 pc/mi/ln	D	0.766
				PM	6260	30.9 pc/mi/ln	D	0.798
I-71 Diverge	I-71/Local Ramps Merge	2	NB	AM	2450	23.7 pc/mi/ln	C	0.618
				PM	4000	-	F	1.019
I-71/Local Ramps Merge	WHV Diverge	5	NB	AM	5790	22.5 pc/mi/ln	C	0.588
				PM	8620	34.8 pc/mi/ln	D	0.875
WHV Diverge	Bank/WHV Merge	5	NB	AM	4220	16.4 pc/mi/ln	B	0.428
				PM	7670	30.0 pc/mi/ln	D	0.778
Bank/WHV Merge	Central Pkwy Merge	6	NB	AM	5790	18.8 pc/mi/ln	C	0.490
				PM	8890	28.9 pc/mi/ln	D	0.752
North of Central Pkwy Merge		6	NB	AM	6300	20.4 pc/mi/ln	C	0.533
				PM	9120	29.7 pc/mi/ln	D	0.771
North of WHV Diverge	WHV Diverge	5	SB	AM	9780	44.1 pc/mi/ln	E	0.992
				PM	7230	28.1 pc/mi/ln	D	0.734
WHV Diverge	Findlay Street Diverge	5	SB	AM	8670	35.1 pc/mi/ln	E	0.880
				PM	6720	26.1 pc/mi/ln	D	0.682
Findlay Street Diverge	I-71 NB/Local Diverge	5	SB	AM	8400	33.5 pc/mi/ln	D	0.852
				PM	6270	24.4 pc/mi/ln	C	0.636
I-71 NB/Local Diverge	I-71 SB Merge	2	SB	AM	3920	44.9 pc/mi/ln	E	0.999
				PM	2730	26.7 pc/mi/ln	D	0.696
I-71 SB Merge	Local Merge	4	SB	AM	6230	30.7 pc/mi/ln	D	0.794
				PM	5900	29.3 pc/mi/ln	D	0.762
Local Merge	W 12th Merge	5	SB	AM	6560	26.0 pc/mi/ln	C	0.678
				PM	8930	37.7 pc/mi/ln	E	0.919
W 12th Merge	Kyles/Dixie Diverge	6	SB	AM	7340	24.5 pc/mi/ln	C	0.638
				PM	10390	36.1 pc/mi/ln	E	0.895
Kyles/Dixie Diverge	Kyles Merge	4	SB	AM	6460	33.0 pc/mi/ln	D	0.842
				PM	8570	-	F	1.107
Kyles Merge	Dixie Merge	5	SB	AM	6810	27.2 pc/mi/ln	D	0.710
				PM	9130	39.6 pc/mi/ln	E	0.944
South of Dixie/Kyles Merge		4	SB	AM	7150	38.7 pc/mi/ln	E	0.932
				PM	9760	-	F	1.261

Alternative C I-71 Freeway Segments								
Freeway Segment		Number of Lanes	Direction	Peak	Volume	Density	LOS	Volume/ Capacity
From	To							
I-75 NB Diverge	W 9th/Local Merge	2	NB	AM	3620	37.7 pc/mi/ln	E	0.918
				PM	2260	22.1 pc/mi/ln	C	0.576
W 9th/Local Merge	US 50/I-75 SB Merge	2	NB	AM	4470	-	F	1.134
				PM	2660	26.0 pc/mi/ln	C	0.678
US 50/I-75 SB Merge	US 50 Diverge	4	NB	AM	7480	40.0 pc/mi/ln	E	0.949
				PM	5020	24.4 pc/mi/ln	C	0.637
US 50 Diverge	W 2nd Merge	2	NB	AM	5320	-	F	1.337
				PM	2510	24.2 pc/mi/ln	C	0.631
W 2nd Merge	W 5th Merge	3	NB	AM	5380	36.5 pc/mi/ln	E	0.901
				PM	2800	18.0 pc/mi/ln	B	0.469

\* Indicates Weave Segment

## Alternative C Traffic Data - Freeway Segments

Data Corresponds With Level of Service Exhibits

Alternative C I-71 Freeway Segments								
Freeway Segment		Number of Lanes	Direction	Peak	Volume	Density	LOS	Volume/ Capacity
From	To							
W 5th Merge	I-471 Merge	3	NB	AM	5570	38.7 pc/mi/ln	E	0.933
				PM	3330	21.4 pc/mi/ln	C	0.558
I-471 Merge	Gilbert Merge	3	NB	AM	7530	-	F	1.255
				PM	4440	28.4 pc/mi/ln	D	0.740
North of I-471 Diverge		3	SB	AM	5230	34.7 pc/mi/ln	D	0.872
				PM	6490	-	F	1.082
I-471 Diverge	3rd Street Diverge	3	SB	AM	4580	29.5 pc/mi/ln	D	0.767
				PM	4960	32.4 pc/mi/ln	D	0.831
3rd Street Diverge	US 50 Merge	2	SB	AM	3120	30.2 pc/mi/ln	D	0.784
				PM	4490	-	F	1.128
US 50 Merge	I-75 NB/US 50 Diverge	4	SB	AM	5440	26.5 pc/mi/ln	D	0.690
				PM	6460	31.9 pc/mi/ln	D	0.819
I-75 NB/US 50 Diverge	SB Local Diverge	2	SB	AM	2500	24.3 pc/mi/ln	C	0.634
				PM	3490	36.6 pc/mi/ln	E	0.902
SB Local Diverge	I-75 SB Merge	2	SB	AM	2310	22.5 pc/mi/ln	C	0.586
				PM	3170	31.9 pc/mi/ln	D	0.819

Alternative C US 50 Freeway Segments								
Freeway Segment		Number of Lanes	Direction	Peak	Volume	Density	LOS	Volume/ Capacity
From	To							
West of Freeman Avenue Diverge		3	EB	AM	3430	21.7 pc/mi/ln	C	0.566
				PM	1250	7.9 pc/mi/ln	A	0.206
Freeman Avenue Diverge	Freeman Avenue Merge	2	EB	AM	2870	27.2 pc/mi/ln	D	0.710
				PM	1110	10.5 pc/mi/ln	A	0.275
Freeman Avenue Merge	W 6th Street Merge	4	EB	AM	2920	16.79 pc/mi/ln*	B	0.460
				PM	1460	7.84 pc/mi/ln*	A	0.230
W 6th Street Merge	I-75 SB Diverge	4	EB	AM	3140	18.95 pc/mi/ln*	B	0.527
				PM	2220	13.17 pc/mi/ln*	B	0.397
I-75 SB Diverge	W 2nd Diverge	2	EB	AM	1950	18.3 pc/mi/ln	C	0.478
				PM	1230	11.6 pc/mi/ln	B	0.303
I-75 Merge	I-71 SB Merge	3	WB	AM	950	6.1 pc/mi/ln	A	0.158
				PM	1700	10.7 pc/mi/ln	A	0.279
I-71 SB Merge	Gest Street Diverge	4	WB	AM	1940	14.63 pc/mi/ln*	B	0.410
				PM	3270	28.55 pc/mi/ln*	D	0.678
Gest Street Diverge	Linn Street Diverge	4	WB	AM	1290	6.87 pc/mi/ln*	A	0.226
				PM	2820	17.43 pc/mi/ln*	B	0.490
Linn Street Diverge	Freeman Avenue Merge	3	WB	AM	730	4.7 pc/mi/ln	A	0.122
				PM	2540	16.1 pc/mi/ln	B	0.419
West of Freeman Avenue Merge		3	WB	AM	910	5.8 pc/mi/ln	A	0.152
				PM	3030	19.2 pc/mi/ln	C	0.500

Alternative C I-71/I-75 Connector Freeway Segments								
Freeway Segment		Number of Lanes	Direction	Peak	Volume	Density	LOS	Volume/ Capacity
From	To							
I-75 NB Split	W 12th Diverge	2	NB	AM	2840	27.0 pc/mi/ln	D	0.703
				PM	2010	19.1 pc/mi/ln	C	0.498
W 12th Diverge	W 9th Merge	2	NB	AM	1700	16.1 pc/mi/ln	B	0.421
				PM	810	7.7 pc/mi/ln	A	0.200
W 9th Merge	W 2nd Diverge	3	NB	AM	3440	21.8 pc/mi/ln	C	0.568
				PM	2010	12.7 pc/mi/ln	B	0.332
W 2nd Diverge	W 5th Street Diverge	3	NB	AM	2240	14.2 pc/mi/ln	B	0.370
				PM	1580	10.0 pc/mi/ln	A	0.261
W 5th Street Diverge	US 50 Diverge	2	NB	AM	1660	15.8 pc/mi/ln	B	0.411
				PM	1300	12.3 pc/mi/ln	B	0.322
US 50 Diverge	W 4th Merge	2	NB	AM	810	7.7 pc/mi/ln	A	0.200
				PM	470	4.5 pc/mi/ln	A	0.116
W 4th Merge	I-71 SB Merge	3	NB	AM	1140	7.3 pc/mi/ln	A	0.189
				PM	2310	14.6 pc/mi/ln	B	0.381

\*Indicates Weave Segment



## Alternative C Traffic Data - Freeway Segments

*Data Corresponds With Level of Service Exhibits*

Alternative C I-71/I-75 Connector Freeway Segments								
Freeway Segment		Number of Lanes	Direction	Peak	Volume	Density	LOS	Volume/ Capacity
From	To							
I-71 SB Merge	W 6th/W 9th Merge	3	NB	AM	3090	19.6 pc/mi/ln	C	0.512
				PM	3710	23.5 pc/mi/ln	C	0.612
W 6th/W 9th Merge	I-75 NB Merge	4	NB	AM	3340	15.9 pc/mi/ln	B	0.415
				PM	4620	21.7 pc/mi/ln	C	0.566
I-71 SB Diverge	US 50 Diverge	2	NB	AM	2940	28.2 pc/mi/ln	D	0.735
				PM	2970	28.2 pc/mi/ln	D	0.735
US 50 Diverge	Connector Merge	1	NB	AM	1950	42.0 pc/mi/ln	E	0.970
				PM	1400	26.3 pc/mi/ln	D	0.687
I-75 SB Diverge	WHV Merge	3	SB	AM	4480	28.5 pc/mi/ln	D	0.743
				PM	3540	22.4 pc/mi/ln	C	0.584
WHV Merge	Local CD Split	4	SB	AM	5840	34.63 pc/mi/ln*	D	0.836
				PM	4310	27.01 pc/mi/ln*	C	0.687
Local CD Split	W 7th Diverge	3	SB	AM	4970	31.9 pc/mi/ln	D	0.820
				PM	2420	15.3 pc/mi/ln	B	0.399
W 7th Diverge	W 2nd Diverge	3	SB	AM	3560	22.5 pc/mi/ln	C	0.587
				PM	2230	14.1 pc/mi/ln	B	0.368
W 2nd Diverge	W 5th Diverge	2	SB	AM	2000	19.2 pc/mi/ln	C	0.500
				PM	1390	13.2 pc/mi/ln	B	0.344
W 5th Diverge	US 50 Merge	1	SB	AM	1320	25.3 pc/mi/ln	C	0.660
				PM	1220	23.0 pc/mi/ln	C	0.601
US 50 Merge	I-71 NB Merge	2	SB	AM	3010	28.9 pc/mi/ln	D	0.753
				PM	2360	22.3 pc/mi/ln	C	0.582
I-71 Connector Diverge	US 50 Merge	1	SB	AM	1560	29.1 pc/mi/ln	D	0.757
				PM	840	15.7 pc/mi/ln	B	0.410
US 50 Merge	W 2nd Merge	2	SB	AM	1820	16.9 pc/mi/ln	B	0.442
				PM	930	8.7 pc/mi/ln	A	0.227
Local CD Split	Freeman Diverge	1	SB	AM	870	16.5 pc/mi/ln	B	0.431
				PM	1890	39.0 pc/mi/ln	E	0.936
Freeman Diverge	Ezzard Charles Merge	1	SB	AM	100	1.9 pc/mi/ln	A	0.050
				PM	1370	26.0 pc/mi/ln	C	0.678
Ezzard Charles Merge	W 9th Merge	1	SB	AM	200	3.8 pc/mi/ln	A	0.099
				PM	1570	29.9 pc/mi/ln	D	0.777
W 9th Merge	US 50 Merge	1	SB	AM	270	5.1 pc/mi/ln	A	0.134
				PM	2070	-	F	1.025
US 50 Merge	I-71 SB Merge	1	SB	AM	940	18.1 pc/mi/ln	C	0.472
				PM	2890	-	F	1.431
I-71 SB Merge	W 9th Diverge (KY)	2	SB	AM	1410	13.7 pc/mi/ln	B	0.358
				PM	4660	-	F	1.188
W 9th Diverge (KY)	I-75 SB Merge	1	SB	AM	330	6.4 pc/mi/ln	A	0.167
				PM	3030	-	F	1.544
I-71 SB Diverge	W 3rd Merge	1	SB	AM	190	3.7 pc/mi/ln	A	0.096
				PM	320	6.3 pc/mi/ln	A	0.165
W 3rd Merge	Local CD Merge	1	SB	AM	470	9.1 pc/mi/ln	A	0.238
				PM	1770	37.4 pc/mi/ln	E	0.915

\* Indicates Weave Segment

### Alternative C Traffic Data - Intersections

*Data Corresponds With Level of Service Exhibits*

HCS Results - Signalized Intersections - 2035 Alternative C Volumes												
ID	Intersection	Peak	Eastbound		Westbound		Northbound		Southbound		Overall	
			Delay	LOS	Delay	LOS	Delay	LOS	Delay	LOS	Delay	LOS
OH-1	Bank Street & Dalton Avenue	AM	18.9s	B	20.5s	C	19.3s	B	20.8s	C	20.2s	C
		PM	19.2s	B	24.3s	C	21.4s	C	24.6s	C	23.3s	C
OH-2	Bank Street & Winchell Avenue	AM	11.1s	B	10.7s	B	11.2s	B	N/A	N/A	11.1s	B
		PM	12.5s	B	11.5s	B	12.9s	B	N/A	N/A	12.7s	B
OH-3	Central Pkwy & Linn Street	AM	24.4s	C	6.4s	A	23.3s	C	24.2s	C	20.6s	C
		PM	8.6s	A	61.3s	E	58.9s	E	26.4s	C	45.0s	D
OH-5	Findlay Street & Dalton Avenue	AM	17.5s	B	18.2s	B	18.0s	B	10.8s	B	14.4s	B
		PM	19.2s	B	19.8s	B	19.6s	B	10.5s	B	15.8s	B
OH-6	Findlay Street & Western Avenue	AM	13.2s	B	13.1s	B	N/A	N/A	13.3s	B	13.2s	B
		PM	13.5s	B	13.3s	B	N/A	N/A	13.4s	B	13.4s	B
OH-7	Findlay Street & Winchell Avenue	AM	13.9s	B	13.4s	B	13.7s	B	N/A	N/A	13.7s	B
		PM	14.6s	B	14.0s	B	14.6s	B	N/A	N/A	14.6s	B
OH-8	Liberty Street & Dalton Avenue	AM	11.5s	B	12.1s	B	11.4s	B	11.9s	B	11.7s	B
		PM	12.6s	B	13.8s	B	10.7s	B	13.8s	B	12.9s	B
OH-9	Liberty Street & Western Avenue	AM	10.9s	B	10.4s	B	N/A	N/A	11.1s	B	10.8s	B
		PM	10.8s	B	10.5s	B	N/A	N/A	11.1s	B	10.8s	B
OH-10	Liberty Street & Winchell Avenue	AM	11.6s	B	11.2s	B	11.5s	B	N/A	N/A	11.5s	B
		PM	11.6s	B	12.4s	B	12.3s	B	N/A	N/A	12.2s	B
OH-11	Liberty Street & Linn Street	AM	12.6s	B	12.7s	B	12.8s	B	12.6s	B	12.7s	B
		PM	12.0s	B	13.7s	B	13.4s	B	12.8s	B	13.2s	B
OH-12	Ezzard Charles WB & Western Avenue	AM	N/A	N/A	18.6s	B	N/A	N/A	18.5s	B	18.5s	B
		PM	N/A	N/A	19.2s	B	N/A	N/A	19.3s	B	19.3s	B
OH-13	Ezzard Charles WB & Winchell Avenue	AM	N/A	N/A	10.9s	B	11.0s	B	N/A	N/A	10.9s	B
		PM	N/A	N/A	12.3s	B	12.0s	B	N/A	N/A	12.1s	B
OH-14	Ezzard Charles EB & Western Avenue	AM	18.6s	B	N/A	N/A	N/A	N/A	18.3s	B	18.3s	B
		PM	18.7s	B	N/A	N/A	N/A	N/A	18.8s	B	18.8s	B
OH-15	Ezzard Charles EB & Winchell Avenue	AM	11.3s	B	N/A	N/A	11.6s	B	N/A	N/A	11.5s	B
		PM	11.6s	B	N/A	N/A	11.3s	B	N/A	N/A	11.4s	B
OH-16	Ezzard Charles & Linn Street	AM	13.5s	B	12.3s	B	13.2s	B	12.8s	B	13.1s	B
		PM	12.7s	B	13.5s	B	13.3s	B	13.2s	B	13.3s	B
OH-17	Gest Street & Dalton Avenue	AM	15.0s	B	15.8s	B	15.9s	B	16.1s	B	15.8s	B
		PM	16.8s	B	17.0s	B	13.9s	B	17.1s	B	16.4s	B
OH-18	Gest Street & Western Avenue	AM	14.6s	B	14.8s	B	N/A	N/A	15.0s	B	14.8s	B
		PM	15.1s	B	14.4s	B	N/A	N/A	14.9s	B	14.8s	B
OH-19	Gest Street & Freeman Avenue	AM	17.0s	B	26.3s	C	23.6s	C	26.4s	C	24.5s	C
		PM	15.8s	B	25.2s	C	25.1s	C	24.6s	C	22.7s	C
OH-20	Linn/W 3rd Street & Gest Street	AM	15.2s	B	17.1s	B	17.2s	B	9.9s	A	15.3s	B
		PM	16.6s	B	17.8s	B	18.0s	B	10.4s	B	16.3s	B
OH-23	8th Street & Dalton Avenue	AM	12.8s	B	19.4s	B	18.4s	B	19.7s	B	16.6s	B
		PM	12.2s	B	21.0s	C	18.2s	B	21.3s	C	19.3s	B
OH-24	8th Street & Freeman Avenue	AM	24.2s	C	21.5s	C	24.7s	C	21.9s	C	23.4s	C
		PM	23.0s	C	23.7s	C	22.4s	C	23.4s	C	23.3s	C
OH-25	8th Street & Linn Street	AM	21.7s	C	19.6s	B	20.8s	C	21.7s	C	21.3s	C
		PM	25.0s	C	25.5s	C	25.9s	C	19.5s	B	24.0s	C
OH-26	WHV & Spring Grove Avenue	AM	25.1s	C	27.2s	C	16.7s	B	27.8s	C	24.9s	C
		PM	23.7s	C	46.6s	D	40.0s	D	45.8s	D	41.0s	D
OH-27	Dalton Avenue & Linn Street	AM	13.5s	B	14.9s	B	14.8s	B	14.2s	B	14.5s	B
		PM	18.3s	B	10.9s	B	18.2s	B	18.2s	B	17.0s	B
OH-29	W Court Street & Central Avenue	AM	16.5s	B	13.6s	B	16.4s	B	N/A	N/A	16.0s	B
		PM	13.0s	B	13.3s	B	13.3s	B	N/A	N/A	13.3s	B
OH-30	W 9th Street & Central Avenue	AM	N/A	N/A	13.0s	B	12.9s	B	12.2s	B	12.9s	B
		PM	N/A	N/A	14.7s	B	14.9s	B	14.7s	B	14.8s	B
OH-31	W 7th Street & Central Avenue	AM	16.2s	B	N/A	N/A	16.2s	B	N/A	N/A	16.2s	B
		PM	13.2s	B	N/A	N/A	13.5s	B	N/A	N/A	13.3s	B
OH-32	W 6th Street & Central Avenue	AM	N/A	N/A	13.8s	B	13.7s	B	N/A	N/A	13.7s	B
		PM	N/A	N/A	14.9s	B	14.6s	B	N/A	N/A	14.8s	B

### Alternative C Traffic Data - Intersections

*Data Corresponds With Level of Service Exhibits*

HCS Results - Signalized Intersections - 2035 Alternative C Volumes												
ID	Intersection	Peak	Eastbound		Westbound		Northbound		Southbound		Overall	
			Delay	LOS	Delay	LOS	Delay	LOS	Delay	LOS	Delay	LOS
OH-33	W 5th Street & Central Avenue	AM	21.5s	C	N/A	N/A	21.7s	C	11.7s	B	21.2s	C
		PM	19.0s	B	N/A	N/A	19.2s	B	9.0s	A	17.9s	B
OH-34	W 4th Street & Central Avenue	AM	N/A	N/A	15.7s	B	15.7s	B	11.5s	B	14.8s	B
		PM	N/A	N/A	230.8s	F	231.5s	F	4.6s	A	212.1s	F
OH-35	W 3rd Street & Central Avenue	AM	43.1s	D	40.3s	D	28.0s	C	43.1s	D	41.0s	D
		PM	85.6s	F	87.1s	F	90.3s	F	67.5s	E	85.3s	F
OH-36	W 4th Street & Plum Street	AM	N/A	N/A	12.8s	B	N/A	N/A	12.6s	B	12.8s	B
		PM	N/A	N/A	14.4s	B	N/A	N/A	14.1s	B	14.4s	B
OH-37	W 3rd Street & Plum Street	AM	N/A	N/A	13.5s	B	N/A	N/A	13.5s	B	13.5s	B
		PM	N/A	N/A	14.2s	B	N/A	N/A	14.2s	B	14.2s	B
OH-38	W 4th Street & Elm Street	AM	N/A	N/A	13.8s	B	13.7s	B	N/A	N/A	13.7s	B
		PM	N/A	N/A	14.9s	B	15.3s	B	N/A	N/A	15.0s	B
OH-39	W 3rd Street & Elm Street	AM	N/A	N/A	14.5s	B	14.5s	B	N/A	N/A	14.5s	B
		PM	N/A	N/A	16.8s	B	17.0s	B	N/A	N/A	16.8s	B
OH-40	W 2nd Street & Elm Street	AM	17.4s	B	N/A	N/A	17.5s	B	N/A	N/A	17.4s	B
		PM	16.0s	B	N/A	N/A	16.1s	B	N/A	N/A	16.0s	B
OH-41	W 3rd Street & Clay Wade Bailey Bridge	AM	34.8s	C	12.1s	B	34.5s	C	N/A	N/A	26.0s	C
		PM	73.1s	E	76.2s	E	75.1s	E	N/A	N/A	75.1s	E
OH-42	WHV & I-75 NB Ramps	AM	24.5s	C	N/A	N/A	23.9s	C	N/A	N/A	24.2s	C
		PM	21.4s	C	N/A	N/A	21.9s	C	N/A	N/A	21.7s	C
OH-43	W McMillan Street & Central Pkwy	AM	26.3s	C	22.1s	C	21.4s	C	25.9s	C	25.1s	C
		PM	17.1s	B	45.5s	D	47.7s	D	46.1s	D	41.2s	D
OH-44	W McMillan Street & W McMicken Avenue	AM	17.4s	B	7.1s	A	16.2s	B	17.3s	B	15.6s	B
		PM	16.7s	B	9.3s	A	15.0s	B	17.0s	B	13.3s	B
OH-47	W McMillan Street/Fairview Avenue/Ravine Street	AM	See Below									
		PM	See Below									
OH-50	I-75 NB Ramps & Central Pkwy	AM	37.5s	D	N/A	N/A	37.2s	D	36.4s	D	37.0s	D
		PM	20.4s	C	N/A	N/A	16.6s	B	20.3s	C	18.3s	B
OH-51	WHV & I-75 SB Ramps	AM	40.2s	D	17.5s	B	N/A	N/A	39.4s	D	37.5s	D
		PM	14.4s	B	21.1s	C	N/A	N/A	20.8s	C	18.9s	B
KY-2	W 4th Street & Philadelphia Street	AM	N/A	N/A	16.1s	B	13.8s	B	15.8s	B	15.4s	B
		PM	N/A	N/A	18.3s	B	15.6s	B	18.2s	B	17.6s	B
KY-3	W 4th Street & Bakewell Street	AM	N/A	N/A	13.9s	B	12.9s	B	13.6s	B	13.8s	B
		PM	N/A	N/A	14.7s	B	14.3s	B	14.3s	B	14.6s	B
KY-4	W 4th Street & Main Street	AM	N/A	N/A	14.1s	B	14.1s	B	10.9s	B	13.2s	B
		PM	N/A	N/A	29.0s	C	6.5s	A	31.5s	C	28.3s	C
KY-7	W 5th Street & Philadelphia Street	AM	18.0s	B	N/A	N/A	17.6s	B	18.0s	B	18.0s	B
		PM	17.8s	B	N/A	N/A	16.6s	B	17.8s	B	17.7s	B
KY-9	W 5th Street & Main Street	AM	16.2s	B	N/A	N/A	16.7s	B	16.4s	B	16.3s	B
		PM	42.2s	D	N/A	N/A	8.2s	A	43.8s	D	40.3s	D
KY-10	Pike Street & Bullock Street	AM	27.3s	C	27.7s	C	N/A	N/A	28.2s	C	27.7s	C
		PM	45.6s	D	43.3s	D	N/A	N/A	44.3s	D	44.1s	D
KY-11	Pike Street & Jillians Way	AM	380.7s	F	6.7s	A	401.5s	F	N/A	N/A	304.5s	F
		PM	110.0s	F	10.0s+	B	112.8s	F	N/A	N/A	69.8s	E
KY-14	Dixie Hwy & Kyles Lane	AM	140.3s	F	157.3s	F	148.5s	F	28.9s	C	145.5s	F
		PM	108.0s	F	102.4s	F	106.5s	F	21.0s	C	103.8s	F
KY-15	I-75 SB Ramps & Kyles Lane	AM	N/A	N/A	23.3s	C	14.6s	B	23.6s	C	20.3s	C
		PM	N/A	N/A	58.1s	E	43.3s	D	51.6s	D	50.9s	D
KY-16	I-75 NB Ramps & Kyles Lane	AM	21.5s	C	N/A	N/A	21.0s	C	20.7s	C	20.9s	C
		PM	24.2s	C	N/A	N/A	23.5s	C	19.1s	B	21.5s	C
KY-17	Higland Avenue & Kyles Lane	AM	27.4s	C	175.9s	F	186.5s	F	20.0s-	B	134.1s	F
		PM	37.3s	D	211.4s	F	88.1s	F	224.8s	F	167.2s	F
KY-18	I-75 SB Ramps & Dixie Hwy	AM	N/A	N/A	18.0s	B	17.6s	B	17.6s	B	17.7s	B
		PM	N/A	N/A	25.1s	C	8.1s	A	24.4s	C	19.9s	B
KY-19	I-75 NB Ramps & Dixie Hwy	AM	27.1s	C	N/A	N/A	26.3s	C	9.2s	A	21.9s	C
		PM	18.7s	B	N/A	N/A	18.7s	B	14.7s	B	16.4s	B
KY-A	W 9th & I-75 NB Ramps	AM	33.7s	C	34.3s	C	34.4s	C	N/A	N/A	34.3s	C
		PM	32.9s	C	33.3s	C	33.1s	C	N/A	N/A	33.2s	C



### Alternative C Traffic Data - Ramp Segments

*Data Corresponds With Level of Service Exhibits*

Alternative C I-75 Ramp Junctions					
Ramp Junction	Direction	Ramp Volumes	Peak	Density	LOS
Dixie Highway Diverge	NB	720	AM	-	F
		1100	PM	-	F
Dixie Highway/Kyles Lane Split	NB	280	AM	14.9 pc/mi/l <sub>n</sub>	B
		380	PM	22.7 pc/mi/l <sub>n</sub>	C
Dixie Highway Merge	NB	1000	AM	31.9 pc/mi/l <sub>n</sub>	D
		380	PM	37.7 pc/mi/l <sub>n</sub>	E
Kyles Lane Merge	NB	1470	AM	29.1 pc/mi/l <sub>n</sub>	D
		710	PM	29.8 pc/mi/l <sub>n</sub>	D
Local/W 12th Diverge	NB	2840	AM	29.5 pc/mi/l <sub>n</sub>	D
		2010	PM	30.9 pc/mi/l <sub>n</sub>	D
I-71 NB/I-75 NB Split	NB	3620	AM	37.7 pc/mi/l <sub>n</sub>	E
		2260	PM	-	F
I-71 SB/Local Merge	NB	3340	AM	23.7 pc/mi/l <sub>n</sub>	C
		4620	PM	-	F
WHV Diverge	NB	1570	AM	29.9 pc/mi/l <sub>n</sub>	D
		950	PM	35.1 pc/mi/l <sub>n</sub>	E
WHV/Central Split	NB	650	AM	32.3 pc/mi/l <sub>n</sub>	D
		190	PM	19.4 pc/mi/l <sub>n</sub>	C
WHV Merge	NB	1570	AM	32.3 pc/mi/l <sub>n</sub>	D
		1220	PM	30.0 pc/mi/l <sub>n</sub>	D
Central Pkwy Merge	NB	510	AM	19.9 pc/mi/l <sub>n</sub>	B
		230	PM	28.8 pc/mi/l <sub>n</sub>	D
WHV Diverge	SB	1110	AM	40.6 pc/mi/l <sub>n</sub>	E
		510	PM	27.9 pc/mi/l <sub>n</sub>	C
Findlay Diverge	SB	270	AM	31.6 pc/mi/l <sub>n</sub>	D
		450	PM	25.8 pc/mi/l <sub>n</sub>	C
I-71 NB Diverge	SB	4480	AM	44.9 pc/mi/l <sub>n</sub>	E
		3540	PM	26.7 pc/mi/l <sub>n</sub>	D
I-71 SB Merge	SB	2310	AM	44.9 pc/mi/l <sub>n</sub>	E
		3170	PM	31.9 pc/mi/l <sub>n</sub>	D
Local Merge	SB	330	AM	30.7 pc/mi/l <sub>n</sub>	D
		3030	PM	-	F
W 12th Merge	SB	780	AM	26.0 pc/mi/l <sub>n</sub>	C
		1460	PM	37.7 pc/mi/l <sub>n</sub>	E
Kyles Lane Diverge	SB	880	AM	33.0 pc/mi/l <sub>n</sub>	D
		1820	PM	-	F
Kyles/Dixie Split	SB	690	AM	18.4 pc/mi/l <sub>n</sub>	C
		1140	PM	38.5 pc/mi/l <sub>n</sub>	E
Kyles/Dixie Merge	SB	350	AM	11.1 pc/mi/l <sub>n</sub>	B
		560	PM	25.3 pc/mi/l <sub>n</sub>	C
Kyles CD/Dixie exit split	SB	190	AM	11.1 pc/mi/l <sub>n</sub>	B
		680	PM	25.3 pc/mi/l <sub>n</sub>	C
Kyles CD merge	SB	350	AM	33.0 pc/mi/l <sub>n</sub>	D
		560	PM	-	F
Dixie Merge	SB	340	AM	23.4 pc/mi/l <sub>n</sub>	C
		630	PM	33.6 pc/mi/l <sub>n</sub>	D

Alternative C I-71 Ramp Junctions					
Ramp Junction	Direction	Ramp Volumes	Peak	Density	LOS
W 9th/Pike Merge	NB	850	AM	-	F
		400	PM	26.3 pc/mi/l <sub>n</sub>	C
US 50/I-75 SB Merge	NB	3010	AM	-	F
		2360	PM	26.0 pc/mi/l <sub>n</sub>	C
US 50 Diverge	NB	2160	AM	-	F
		2510	PM	24.4 pc/mi/l <sub>n</sub>	C

## Alternative C Traffic Data - Ramp Segments

*Data Corresponds With Level of Service Exhibits*

Alternative C I-71 Ramp Junctions					
Ramp Junction	Direction	Ramp Volumes	Peak	Density	LOS
W 2nd Merge	NB	60	AM	-	F
		290	PM	24.2 pc/mi/l <sub>n</sub>	C
W 5th Merge	NB	190	AM	32.6 pc/mi/l <sub>n</sub>	D
		530	PM	21.7 pc/mi/l <sub>n</sub>	C
I-471 Merge	NB	1960	AM	-	F
		1110	PM	29.3 pc/mi/l <sub>n</sub>	D
I-471 Diverge	SB	650	AM	32.3 pc/mi/l <sub>n</sub>	D
		1530	PM	-	F
W 3rd Street Diverge	SB	1460	AM	30.4 pc/mi/l <sub>n</sub>	D
		470	PM	-	F
US 50 Merge	SB	2320	AM	30.2 pc/mi/l <sub>n</sub>	D
		1970	PM	-	F
I-75 NB Diverge	SB	2940	AM	28.2 pc/mi/l <sub>n</sub>	D
		2970	PM	36.6 pc/mi/l <sub>n</sub>	E
SB Local Diverge	SB	190	AM	24.8 pc/mi/l <sub>n</sub>	C
		320	PM	35.4 pc/mi/l <sub>n</sub>	E

Alternative C US 50 Ramp Junctions					
Ramp Junction	Direction	Ramp Volumes	Peak	Density	LOS
Freeman Avenue Diverge	EB	560	AM	27.2 pc/mi/l <sub>n</sub>	D
		140	PM	10.5 pc/mi/l <sub>n</sub>	A
W 2nd Diverge	EB	260	AM	32.3 pc/mi/l <sub>n</sub>	D
		90	PM	21.5 pc/mi/l <sub>n</sub>	C
I-75 Merge	WB	850	AM	16.3 pc/mi/l <sub>n</sub>	B
		830	PM	15.8 pc/mi/l <sub>n</sub>	B
Freeman Avenue Merge	WB	180	AM	7.9 pc/mi/l <sub>n</sub>	A
		490	PM	19.8 pc/mi/l <sub>n</sub>	B

Alternative C I-71/-75 Connector Ramp Junctions					
Ramp Junction	Direction	Ramp Volumes	Peak	Density	LOS
W 12th Diverge	NB	1140	AM	27.6 pc/mi/l <sub>n</sub>	C
		1200	PM	19.4 pc/mi/l <sub>n</sub>	B
W 9th Merge	NB	1740	AM	36.5 pc/mi/l <sub>n</sub>	E
		1200	PM	24.7 pc/mi/l <sub>n</sub>	C
W 2nd Diverge	NB	1200	AM	24.6 pc/mi/l <sub>n</sub>	C
		430	PM	14.5 pc/mi/l <sub>n</sub>	B
W 5th Diverge	NB	580	AM	15.8 pc/mi/l <sub>n</sub>	B
		280	PM	12.3 pc/mi/l <sub>n</sub>	B
US 50 Diverge	NB	850	AM	16.0 pc/mi/l <sub>n</sub>	B
		830	PM	12.5 pc/mi/l <sub>n</sub>	B
W 4th Merge	NB	330	AM	7.7 pc/mi/l <sub>n</sub>	A
		1840	PM	39.2 pc/mi/l <sub>n</sub>	E
I-71 SB/US 50 Diverge	NB	990	AM	42.0 pc/mi/l <sub>n</sub>	E
		1570	PM	30.1 pc/mi/l <sub>n</sub>	D
I-71 SB Merge	NB	1950	AM	42.0 pc/mi/l <sub>n</sub>	E
		1400	PM	26.3 pc/mi/l <sub>n</sub>	D
W 6th/W 9th Merge	NB	250	AM	19.6 pc/mi/l <sub>n</sub>	C
		910	PM	23.5 pc/mi/l <sub>n</sub>	C
W 7th Diverge	SB	1410	AM	34.2 pc/mi/l <sub>n</sub>	D
		190	PM	17.3 pc/mi/l <sub>n</sub>	B
W 2nd Diverge	SB	1560	AM	29.1 pc/mi/l <sub>n</sub>	D
		840	PM	15.7 pc/mi/l <sub>n</sub>	B
W 5th Diverge (OH)	SB	680	AM	25.3 pc/mi/l <sub>n</sub>	C
		170	PM	23.0 pc/mi/l <sub>n</sub>	C
US 50 Merge	SB	1690	AM	32.3 pc/mi/l <sub>n</sub>	D
		1140	PM	23.0 pc/mi/l <sub>n</sub>	C

### Alternative C Traffic Data - Ramp Segments

*Data Corresponds With Level of Service Exhibits*

Alternative C I-71-75 Connector Ramp Junctions					
Ramp Junction	Direction	Ramp Volumes	Peak	Density	LOS
W 2nd to US 50 Merge	SB	260	AM	29.1 pc/mi/ln	D
		90	PM	15.7 pc/mi/ln	B
Freeman Diverge	SB	770	AM	16.9 pc/mi/ln	B
		520	PM	39.0 pc/mi/ln	E
Ezzard Charles Merge	SB	100	AM	3.8 pc/mi/ln	A
		200	PM	29.9 pc/mi/ln	D
W 9th Merge	SB	70	AM	5.1 pc/mi/ln	A
		500	PM	-	F
US 50 Merge (Local CD)	SB	670	AM	18.1 pc/mi/ln	C
		820	PM	-	F
W 3rd Merge	SB	280	AM	9.1 pc/mi/ln	A
		1450	PM	35.4 pc/mi/ln	E
I-71 SB Merge	SB	470	AM	18.1 pc/mi/ln	C
		1770	PM	-	F
W 9th Diverge	SB	1080	AM	22.6 pc/mi/ln	C
		1630	PM	-	F

## Alternative D Traffic Data - Freeway Segments

*Data Corresponds With Level of Service Exhibits*

Alternative D I-75 Freeway Segments								
Freeway Segment		Direction	Number of Lanes	Peak	Volume	Density	LOS	Volume/ Capacity
From	To							
South of Dixie Highway	Dixie Highway Diverge	NB	3	AM	7160	-	F	1.216
				PM	8280	-	F	1.413
Dixie Highway Diverge	Dixie Highway Merge	NB	3	AM	6440	-	F	1.094
				PM	7180	-	F	1.225
Dixie Highway Merge	Kyles Lane Merge	NB	5	AM	7440	29.1 pc/mi/ln	D	0.758
				PM	7560	29.8 pc/mi/ln	D	0.774
Kyles Lane Merge	W 12th/W 5th Diverge	NB	6	AM	8910	29.1 pc/mi/ln	D	0.757
				PM	8270	27.1 pc/mi/ln	D	0.706
W 12th/W 5th Diverge	I-71 Diverge	NB	4	AM	6070	29.5 pc/mi/ln	D	0.766
				PM	6260	30.9 pc/mi/ln	D	0.798
I-71 Diverge	Local NB Merge	NB	2	AM	2450	23.7 pc/mi/ln	C	0.618
				PM	4000	-	F	1.019
Local NB Merge	Central Pkwy Diverge	NB	5	AM	2960	23.1 pc/mi/ln	C	0.300
				PM	4290	35.3 pc/mi/ln	E	0.435
Central Pkwy Diverge	WHV Merge	NB	5	AM	4690	18.2 pc/mi/ln	C	0.476
				PM	7790	30.5 pc/mi/ln	D	0.790
WHV Merge	Central Pkwy Merge	NB	6	AM	5980	19.4 pc/mi/ln	C	0.506
				PM	8790	28.5 pc/mi/ln	D	0.743
North of Central Pkwy Merge		NB	6	AM	6490	21.0 pc/mi/ln	C	0.549
				PM	9020	29.3 pc/mi/ln	D	0.763
North of WHV Diverge	WHV Diverge	SB	5	AM	9840	44.8 pc/mi/ln	E	0.998
				PM	7240	28.2 pc/mi/ln	D	0.735
WHV Diverge	Findlay Diverge	SB	5	AM	8630	34.9 pc/mi/ln	D	0.876
				PM	6680	26.0 pc/mi/ln	C	0.678
Findlay Diverge	I-71 NB/Local Diverge	SB	5	AM	8350	33.3 pc/mi/ln	D	0.847
				PM	6220	24.2 pc/mi/ln	C	0.631
I-71 NB/Local Diverge	I-71 SB Merge	SB	2	AM	3920	44.4 pc/mi/ln	E	0.994
				PM	2730	26.7 pc/mi/ln	D	0.696
I-71 SB Merge	Local Merge	SB	4	AM	6230	30.5 pc/mi/ln	D	0.790
				PM	5900	29.2 pc/mi/ln	D	0.759
Local Merge	W 12th Merge	SB	5	AM	6560	26.0 pc/mi/ln	C	0.678
				PM	8930	37.7 pc/mi/ln	E	0.919
W 12th Merge	Kyles/Dixie Diverge	SB	6	AM	7340	24.5 pc/mi/ln	C	0.638
				PM	10390	36.1 pc/mi/ln	E	0.895
Kyles/Dixie Diverge	Kyles CD Merge	SB	4	AM	6460	33.0 pc/mi/ln	D	0.842
				PM	8570	-	F	1.107
Kyles CD Merge	Dixie Highway Merge	SB	5	AM	6810	27.2 pc/mi/ln	D	0.710
				PM	9130	39.6 pc/mi/ln	E	0.944
South of Dixie Merge		SB	4	AM	7150	38.7 pc/mi/ln	E	0.932
				PM	9760	-	F	1.261

Alternative D I-71 Freeway Segments								
Freeway Segment		Direction	Number of Lanes	Peak	Volume	Density	LOS	Volume/ Capacity
From	To							
I-75 NB Diverge	W 9th/Local Merge	NB	2	AM	3620	37.7 pc/mi/ln	E	0.918
				PM	2260	22.1 pc/mi/ln	C	0.576
W 9th/Local Merge	US 50/I-75 SB Merge	NB	2	AM	4470	-	F	1.134
				PM	2660	26.0 pc/mi/ln	C	0.678
US 50/I-75 SB Merge	US 50 Diverge	NB	4	AM	7480	40.0 pc/mi/ln	E	0.949
				PM	5020	24.4 pc/mi/ln	C	0.637
US 50 Diverge	W 2nd Merge	NB	2	AM	5320	-	F	1.337
				PM	2510	24.2 pc/mi/ln	C	0.631
W 2nd Merge	W 5th Merge	NB	3	AM	5380	36.5 pc/mi/ln	E	0.901
				PM	2800	18.0 pc/mi/ln	B	0.469

\* Indicates Weave Segment



## Alternative D Traffic Data - Freeway Segments

Data Corresponds With Level of Service Exhibits

Alternative D I-71 Freeway Segments								
Freeway Segment		Direction	Number of Lanes	Peak	Volume	Density	LOS	Volume/Capacity
From	To							
W 5th Merge	I-471 Merge	NB	3	AM	5570	38.7 pc/mi/ln	E	0.933
				PM	3330	21.4 pc/mi/ln	C	0.558
I-471 Merge	Gilbert Merge	NB	3	AM	7530	-	F	1.255
				PM	4440	28.4 pc/mi/ln	D	0.740
North of I-471 Diverge		SB	3	AM	5230	34.7 pc/mi/ln	D	0.872
				PM	6490	-	F	1.082
I-471 Diverge	3rd Street Diverge	SB	3	AM	4580	29.5 pc/mi/ln	D	0.767
				PM	4960	32.4 pc/mi/ln	D	0.831
3rd Street Diverge	US 50 Merge	SB	2	AM	3120	30.2 pc/mi/ln	D	0.784
				PM	4490	-	F	1.128
US 50 Merge	I-75 NB/US 50 Diverge	SB	4	AM	5440	26.5 pc/mi/ln	D	0.690
				PM	6460	31.9 pc/mi/ln	D	0.819
I-75 NB/US 50 Diverge	SB Local Diverge	SB	2	AM	2500	24.3 pc/mi/ln	C	0.634
				PM	3490	36.6 pc/mi/ln	E	0.902
SB Local Diverge	I-75 SB Merge	SB	2	AM	2310	22.5 pc/mi/ln	C	0.586
				PM	3170	31.9 pc/mi/ln	D	0.819

Alternative D US 50 Freeway Segments								
Freeway Segment		Direction	Number of Lanes	Peak	Volume	Density	LOS	Volume/Capacity
From	To							
West of Freeman Avenue Diverge		EB	3	AM	3480	22.0 pc/mi/ln	C	0.574
				PM	1220	7.7 pc/mi/ln	A	0.201
Freeman Avenue Diverge	Freeman Avenue Merge	EB	2	AM	2910	27.6 pc/mi/ln	D	0.720
				PM	1080	10.3 pc/mi/ln	A	0.267
Freeman Avenue Merge	W 6th Street Merge	EB	3	AM	2970	21.79 pc/mi/ln*	C	0.611
				PM	1470	10.99 pc/mi/ln*	B	0.336
W 6th Street Merge	I-75 SB Diverge	EB	4	AM	3200	18.26 pc/mi/ln*	B	0.489
				PM	2230	13.13 pc/mi/ln*	B	0.395
I-75 SB Diverge	I-71 NB Diverge	EB	2	AM	2260	21.2 pc/mi/ln	C	0.554
				PM	1320	12.5 pc/mi/ln	B	0.325
I-75 NB Merge	I-71 SB Merge	WB	3	AM	1010	6.4 pc/mi/ln	A	0.167
				PM	1650	10.4 pc/mi/ln	A	0.271
I-71 SB Merge	Gest Street Diverge	WB	4	AM	1980	14.85 pc/mi/ln*	B	0.416
				PM	3180	27.56 pc/mi/ln*	C	0.660
Gest Street Diverge	Linn Street Diverge	WB	3	AM	1460	11.13 pc/mi/ln*	B	0.341
				PM	2750	24.50 pc/mi/ln*	C	0.642
Linn Street Diverge	Freeman Avenue Merge	WB	3	AM	930	5.9 pc/mi/ln	A	0.153
				PM	2490	15.8 pc/mi/ln	B	0.411
West of Freeman Avenue Merge		WB	3	AM	1100	7.0 pc/mi/ln	A	0.182
				PM	2960	18.7 pc/mi/ln	C	0.488

Alternative D I-71/I-75 Connector Freeway Segments								
Freeway Segment		Direction	Number of Lanes	Peak	Volume	Density	LOS	Volume/Capacity
From	To							
I-75 NB Split	W 12th Diverge	NB	3	AM	2840	18.0 pc/mi/ln	B	0.469
				PM	2010	12.7 pc/mi/ln	B	0.332
W 12th Diverge	W 9th Merge	NB	2	AM	1700	16.1 pc/mi/ln	B	0.421
				PM	810	7.7 pc/mi/ln	A	0.200
W 9th Merge	W 2nd Diverge	NB	3	AM	3440	21.8 pc/mi/ln	C	0.568
				PM	2010	12.7 pc/mi/ln	B	0.332
W 2nd Diverge	NB Connector Split	NB	3	AM	2240	14.2 pc/mi/ln	B	0.370
				PM	1340	10.0 pc/mi/ln	A	0.221
NB Connector Split	I-71 SB Merge	NB	1	AM	420	7.9 pc/mi/ln	A	0.207
				PM	240	4.6 pc/mi/ln	A	0.119
I-71 SB Merge	John St Merge	NB	2	AM	2390	22.8 pc/mi/ln	C	0.595
				PM	1680	15.9 pc/mi/ln	B	0.416
John St Merge	NB Connector Converge	NB	3	AM	2780	17.7 pc/mi/ln	B	0.461
				PM	3700	23.4 pc/mi/ln	C	0.611

\* Indicates Weave Segment

## Alternative D Traffic Data - Freeway Segments

*Data Corresponds With Level of Service Exhibits*

Alternative D I-71/I-75 Connector Freeway Segments								
Freeway Segment		Direction	Number of Lanes	Peak	Volume	Density	LOS	Volume/Capacity
From	To							
NB Connector Split	US 50/W 5th Split	NB	2	AM	1820	17.3 pc/mi/ln	B	0.450
				PM	1340	12.7 pc/mi/ln	B	0.332
US 50/W 5th Split	NB Connector Converge	NB	1	AM	510	9.7 pc/mi/ln	A	0.252
				PM	290	5.5 pc/mi/ln	A	0.144
US 50/W 5th Split	W 5th Diverge	NB	1	AM	1310	24.8 pc/mi/ln	C	0.646
				PM	1050	19.7 pc/mi/ln	C	0.515
NB Connector Converge	W 9th/John St Merge	NB	3	AM	2780	20.9 pc/mi/ln	C	0.461
				PM	3700	25.3 pc/mi/ln	C	0.611
W 9th/John St Merge	I-75 NB Merge	NB	4	AM	2980	16.6 pc/mi/ln	B	0.371
				PM	4410	22.2 pc/mi/ln	C	0.543
W 9th/I-71 SB Merge	US 50 Diverge	NB	2	AM	2940	28.2 pc/mi/ln	D	0.735
				PM	2970	28.2 pc/mi/ln	D	0.735
US 50 Diverge	NB Connector Merge	NB	1	AM	1970	42.9 pc/mi/ln	E	0.980
				PM	1440	27.1 pc/mi/ln	D	0.706
NB Connector Merge	US 50 Merge	NB	1	AM	970	18.6 pc/mi/ln	C	0.485
				PM	1530	29.3 pc/mi/ln	D	0.761
I-75 SB Diverge	WHV Merge	SB	3	AM	4430	28.2 pc/mi/ln	D	0.735
				PM	3490	22.1 pc/mi/ln	C	0.576
WHV Merge	Freeman Diverge	SB	4	AM	5950	28.3 pc/mi/ln	D	0.736
				PM	4350	20.6 pc/mi/ln	C	0.538
Freeman Diverge	Ezzard Charles Merge	SB	4	AM	5180	24.6 pc/mi/ln	C	0.641
				PM	3830	18.2 pc/mi/ln	C	0.474
Ezzard Charles Merge	W 5th/W 7th/I-71 SB Diverge	SB	5	AM	5350	23.34 pc/mi/ln*	C	0.602
				PM	4160	22.14 pc/mi/ln*	C	0.678
W 5th/W 7th/I-71 SB Diverge	W 2nd Diverge	SB	2	AM	1430	13.6 pc/mi/ln	B	0.354
				PM	2440	23.1 pc/mi/ln	C	0.604
W 2nd Diverge	W 9th Merge	SB	1	AM	220	4.2 pc/mi/ln	A	0.109
				PM	1720	33.5 pc/mi/ln	D	0.851
W 9th Merge	US 50 Merge	SB	1	AM	270	5.1 pc/mi/ln	A	0.134
				PM	2070	-	F	1.025
US 50 Merge	W 3rd/I-71 SB Merge	SB	1	AM	940	18.1 pc/mi/ln	C	0.472
				PM	2890	-	F	1.431
W 3rd/I-71 SB Merge	W 9th Diverge	SB	2	AM	1410	13.7 pc/mi/ln	B	0.358
				PM	4660	-	F	1.153
W 9th Diverge	I-75 SB Merge	SB	1	AM	330	6.5 pc/mi/ln	A	0.171
				PM	3030	-	F	1.515
W 2nd Diverge	W 7th Diverge	SB	3	AM	3920	24.8 pc/mi/ln	C	0.647
				PM	1720	10.8 pc/mi/ln	A	0.283
W 7th Diverge	W 5th Diverge	SB	2	AM	2470	23.5 pc/mi/ln	C	0.611
				PM	1530	14.4 pc/mi/ln	B	0.377
W 5th Diverge	US 50 Merge	SB	1	AM	1360	25.8 pc/mi/ln	C	0.673
				PM	1250	23.6 pc/mi/ln	C	0.616
US 50 Merge	I-75 NB Merge	SB	2	AM	3010	28.6 pc/mi/ln	D	0.745
				PM	2360	22.3 pc/mi/ln	C	0.582
I-71 SB Diverge	W 3rd Merge	SB	1	AM	190	3.7 pc/mi/ln	A	0.096
				PM	320	6.3 pc/mi/ln	A	0.165
W 3rd Merge	I-71/I-75 SB Connector Merge	SB	1	AM	470	9.2 pc/mi/ln	A	0.240
				PM	1770	35.4 pc/mi/ln	E	0.885

\* Indicates Weave Segment

### Alternative D Traffic Data - Intersections

*Data Corresponds With Level of Service Exhibits*

HCS Results - Signalized Intersections - 2035 Alternative D Volumes												
ID	Intersection	Peak	Eastbound		Westbound		Northbound		Southbound		Overall	
			Delay	LOS	Delay	LOS	Delay	LOS	Delay	LOS	Delay	LOS
OH-1	Bank Street & Dalton Avenue	AM	18.8s	B	20.4s	C	19.1s	B	20.2s	C	19.8s	B
		PM	18.8s	B	23.4s	C	20.9s	C	23.1s	C	22.3s	C
OH-2	Bank Street & Winchell Avenue	AM	11.5s	B	11.0s	B	11.1s	B	N/A	N/A	11.2s	B
		PM	11.8s	B	11.3s	B	11.6s	B	N/A	N/A	11.6s	B
OH-3	Central Pkwy & Linn Street	AM	76.5s	E	9.1s	A	19.1s	B	49.8s	B	57.1s	E
		PM	18.6s	B	89.7s	F	17.6s	B	86.7s	F	66.4s	E
OH-5	Findlay Street & Dalton Avenue	AM	17.5s	B	18.2s	B	18.1s	B	10.7s	B	14.4s	B
		PM	18.7s	B	19.5s	B	19.9s	B	10.8s	B	15.9s	B
OH-6	Findlay Street & Western Avenue	AM	13.5s	B	13.3s	B	N/A	N/A	13.4s	B	13.4s	B
		PM	13.7s	B	13.3s	B	N/A	N/A	13.5s	B	13.5s	B
OH-7	Findlay Street & Winchell Avenue	AM	13.8s	B	13.1s	B	13.6s	B	N/A	N/A	13.6s	B
		PM	14.0s	B	13.2s	B	14.2s	B	N/A	N/A	14.1s	B
OH-8	Liberty Street & Dalton Avenue	AM	11.2s	B	12.0s	B	11.6s	B	12.2s	B	12.0s	B
		PM	12.0s	B	13.5s	B	11.1s	B	13.9s	B	13.0s	B
OH-9	Liberty Street & Western Avenue	AM	11.1s	B	10.6s	B	N/A	N/A	11.2s	B	11.0s	B
		PM	11.2s	B	10.7s	B	N/A	N/A	11.1s	B	11.0s	B
OH-10	Liberty Street & Winchell Avenue	AM	11.6s	B	11.1s	B	11.4s	B	N/A	N/A	11.4s	B
		PM	11.1s	B	11.5s	B	11.8s	B	N/A	N/A	11.6s	B
OH-11	Liberty Street & Linn Street	AM	12.6s	B	12.4s	B	12.6s	B	12.4s	B	12.5s	B
		PM	11.8s	B	13.1s	B	13.5s	B	13.0s	B	13.0s	B
OH-12	Ezzard Charles WB & Western Avenue	AM	N/A	N/A	18.6s	B	N/A	N/A	18.3s	B	18.3s	B
		PM	N/A	N/A	19.2s	B	N/A	N/A	19.4s	B	19.3s	B
OH-13	Ezzard Charles WB & Winchell Avenue	AM	N/A	N/A	10.7s	B	10.9s	B	N/A	N/A	10.8s	B
		PM	N/A	N/A	11.9s	B	11.7s	B	N/A	N/A	11.8s	B
OH-14	Ezzard Charles EB & Western Avenue	AM	18.3s	B	N/A	N/A	N/A	N/A	18.5s	B	18.5s	B
		PM	18.7s	B	N/A	N/A	N/A	N/A	18.9s	B	18.9s	B
OH-15	Ezzard Charles EB & Winchell Avenue	AM	11.3s	B	N/A	N/A	11.2s	B	N/A	N/A	11.2s	B
		PM	11.2s	B	N/A	N/A	11.1s	B	N/A	N/A	11.1s	B
OH-16	Ezzard Charles & Linn Street	AM	13.0s	B	11.6s	B	13.1s	B	12.8s	B	12.8s	B
		PM	12.3s	B	13.2s	B	13.0s	B	13.0s	B	12.9s	B
OH-17	Gest Street & Dalton Avenue	AM	15.2s	B	15.7s	B	15.8s	B	16.0s	B	15.7s	B
		PM	16.8s	B	17.0s	B	13.7s	B	16.7s	B	16.2s	B
OH-18	Gest Street & Western Avenue	AM	14.8s	B	15.0s	B	N/A	N/A	14.8s	B	14.9s	B
		PM	14.9s	B	14.4s	B	N/A	N/A	15.0s	B	14.8s	B
OH-19	Gest Street & Freeman Avenue	AM	16.7s	B	25.6s	C	24.0s	C	25.6s	C	24.1s	C
		PM	16.0s	B	24.4s	C	24.0s	C	24.1s	C	22.2s	C
OH-20	Linn/W 3rd Street & Gest Street	AM	15.1s	B	16.8s	B	17.2s	B	9.8s	A	15.3s	B
		PM	16.4s	B	17.4s	B	17.9s	B	10.2s	B	16.1s	B
OH-23	8th Street & Dalton Avenue	AM	12.8s	B	19.4s	B	18.3s	B	19.4s	B	16.4s	B
		PM	12.2s	B	21.0s	C	18.1s	B	20.8s	C	19.1s	B
OH-24	8th Street & Freeman Avenue	AM	24.4s	C	21.3s	C	24.4s	C	21.3s	C	23.3s	C
		PM	22.9s	C	22.9s	C	22.3s	C	23.3s	C	22.9s	C
OH-25	8th Street & Linn Street	AM	21.6s	C	19.3s	B	20.9s	C	21.6s	C	21.2s	C
		PM	23.3s	C	23.9s	C	24.6s	C	22.3s	C	23.5s	C
OH-26	WHV & Spring Grove Avenue	AM	24.2s	C	22.1s	C	16.9s	B	23.8s	C	22.4s	C
		PM	22.8s	C	40.1s	D	30.6s	C	38.6s	D	33.7s	C
OH-27	Dalton Avenue & Linn Street	AM	13.5s	B	14.7s	B	14.6s	B	14.1s	B	14.4s	B
		PM	17.9s	B	11.1s	B	17.7s	B	17.7s	B	16.7s	B
OH-29	W Court Street & Central Avenue	AM	16.2s	B	13.4s	B	16.6s	B	N/A	N/A	16.0s	B
		PM	13.0s	B	13.2s	B	13.3s	B	N/A	N/A	13.2s	B
OH-30	W 9th Street & Central Avenue	AM	N/A	N/A	12.7s	B	12.7s	B	12.2s	B	12.7s	B
		PM	N/A	N/A	14.2s	B	14.3s	B	13.9s	B	14.2s	B
OH-31	W 7th Street & Central Avenue	AM	16.0s	B	N/A	N/A	16.3s	B	N/A	N/A	16.1s	B
		PM	13.2s	B	N/A	N/A	13.4s	B	N/A	N/A	13.2s	B
OH-32	W 6th Street & Central Avenue	AM	N/A	N/A	13.9s	B	14.0s	B	N/A	N/A	13.9s	B
		PM	N/A	N/A	15.9s	B	16.3s	B	N/A	N/A	15.9s	B
OH-33	W 5th Street & Central Avenue	AM	83.7s	F	N/A	N/A	83.6s	F	11.5s	B	80.7s	F
		PM	36.1s	D	N/A	N/A	37.6s	D	6.4s	A	33.0s	C
OH-34	W 4th Street & Central Avenue	AM	N/A	N/A	19.9s	B	13.9s	B	19.8s	B	17.4s	B
		PM	N/A	N/A	27.7s	C	26.4s	C	27.1s	C	26.9s	C
OH-35	W 3rd Street & Central Avenue	AM	40.9s	D	41.4s	D	36.8s	D	41.4s	D	41.1s	D
		PM	57.7s	E	57.8s	E	55.0s+	E	56.2s	E	56.8s	E

### Alternative D Traffic Data - Intersections

*Data Corresponds With Level of Service Exhibits*

HCS Results - Signalized Intersections - 2035 Alternative D Volumes												
ID	Intersection	Peak	Eastbound		Westbound		Northbound		Southbound		Overall	
			Delay	LOS	Delay	LOS	Delay	LOS	Delay	LOS	Delay	LOS
OH-36	W 4th Street & Plum Street	AM	N/A	N/A	12.5s	B	N/A	N/A	12.6s	B	12.5s	B
		PM	N/A	N/A	13.5s	B	N/A	N/A	13.5s	B	13.5s	B
OH-37	W 3rd Street & Plum Street	AM	N/A	N/A	13.3s	B	N/A	N/A	13.5s	B	13.3s	B
		PM	N/A	N/A	14.1s	B	N/A	N/A	13.9s	B	14.0s	B
OH-38	W 4th Street & Elm Street	AM	N/A	N/A	13.6s	B	13.5s	B	N/A	N/A	13.5s	B
		PM	N/A	N/A	14.6s	B	14.6s	B	N/A	N/A	14.6s	B
OH-39	W 3rd Street & Elm Street	AM	N/A	N/A	14.5s	B	14.5s	B	N/A	N/A	14.5s	B
		PM	N/A	N/A	16.3s	B	16.6s	B	N/A	N/A	16.3s	B
OH-40	W 2nd Street & Elm Street	AM	18.1s	B	N/A	N/A	17.9s	B	N/A	N/A	18.1s	B
		PM	16.1s	B	N/A	N/A	16.2s	B	N/A	N/A	16.1s	B
OH-41	W 3rd Street & Clay Wade Bailey Bridge	AM	15.3s	B	14.9s	B	15.3s	B	N/A	N/A	15.2s	B
		PM	15.4s	B	16.7s	B	16.5s	B	N/A	N/A	16.3s	B
OH-42	WHV & I-75 NB Ramps	AM	19.6s	B	N/A	N/A	19.7s	B	N/A	N/A	19.6s	B
		PM	18.9s	B	N/A	N/A	18.9s	B	N/A	N/A	18.9s	B
OH-43	W McMillan Street & Central Pkwy	AM	26.0s	C	18.5s	B	26.1s	C	25.8s	C	25.5s	C
		PM	16.8s	B	58.4s	E	61.6s	E	57.7s	E	52.4s	D
OH-44	W McMillan Street & W McMicken Avenue	AM	17.1s	B	7.2s	A	16.2s	B	17.2s	B	15.4s	B
		PM	16.6s	B	9.3s	A	15.0s	B	16.9s	B	13.2s	B
OH-47	W McMillan Street/Fairview Avenue/Ravine Street	AM	See Below									
		PM	See Below									
OH-50	I-75 NB Ramps & Central Pkwy	AM	33.4s	C	N/A	N/A	32.9s	C	32.6s	C	32.9s	C
		PM	20.8s	C	N/A	N/A	18.0s	B	20.4s	C	19.2s	B
OH-51	WHV & I-75 SB Ramps	AM	68.0s	E	24.8s	C	N/A	N/A	42.7s	D	56.1s	E
		PM	15.0s	B	22.2s	C	N/A	N/A	22.1s	C	19.9s	B
KY-2	W 4th Street & Philadelphia Street	AM	N/A	N/A	16.1s	B	13.8s	B	15.8s	B	15.4s	B
		PM	N/A	N/A	18.3s	B	15.6s	B	18.2s	B	17.6s	B
KY-3	W 4th Street & Bakewell Street	AM	N/A	N/A	13.9s	B	12.9s	B	13.6s	B	13.8s	B
		PM	N/A	N/A	14.3s	B	14.7s	B	14.7s	B	14.4s	B
KY-4	W 4th Street & Main Street	AM	N/A	N/A	14.1s	B	14.1s	B	10.9s	B	13.2s	B
		PM	N/A	N/A	29.0s	C	6.5s	A	31.5s	C	28.3s	C
KY-7	W 5th Street & Philadelphia Street	AM	18.0s	B	N/A	N/A	17.6s	B	18.0s	B	18.0s	B
		PM	17.8s	B	N/A	N/A	16.6s	B	17.8s	B	17.7s	B
KY-9	W 5th Street & Main Street	AM	16.2s	B	N/A	N/A	16.7s	B	16.4s	B	16.3s	B
		PM	42.2s	D	N/A	N/A	8.2s	A	43.8s	D	40.3s	D
KY-10	Pike Street & Bullock Street	AM	23.6s	C	16.4s	B	N/A	N/A	23.3s	C	21.8s	C
		PM	35.5s	D	36.6s	D	N/A	N/A	35.6s	D	36.0s	D
KY-11	Pike Street & Jillians Way	AM	44.4s	D	14.8s	B	44.7s	D	N/A	N/A	37.6s	D
		PM	15.4s	B	24.5s	C	24.2s	C	N/A	N/A	23.4s	C
KY-14	Dixie Hwy & Kyles Lane	AM	140.3s	F	157.3s	F	148.8s	F	28.5s	C	145.5s	F
		PM	108.0s	F	102.4s	F	106.5s	F	21.0s	C	103.8s	F
KY-15	I-75 SB Ramps & Kyles Lane	AM	N/A	N/A	23.3s	C	14.6s	B	23.6s	C	20.3s	C
		PM	N/A	N/A	53.7s	D	44.2s	D	59.5s	E	52.1s	D
KY-16	I-75 NB Ramps & Kyles Lane	AM	24.5s	C	N/A	N/A	15.8s	B	25.1s	C	22.5s	C
		PM	24.2s	C	N/A	N/A	23.5s	C	19.1s	B	21.5s	C
KY-17	Higland Avenue & Kyles Lane	AM	27.4s	C	175.9s	F	186.5s	F	20.0s	B	134.1s	F
		PM	37.3s	D	211.4s	F	88.1s	F	224.8s	F	167.2s	F
KY-18	I-75 SB Ramps & Dixie Hwy	AM	N/A	N/A	18.0s	B	17.6s	B	17.6s	B	17.7s	B
		PM	N/A	N/A	25.1s	C	8.1s	A	24.4s	C	19.9s	B
KY-19	I-75 NB Ramps & Dixie Hwy	AM	27.1s	C	N/A	N/A	26.3s	C	9.2s	A	21.9s	C
		PM	18.7s	B	N/A	N/A	18.7s	B	14.7s	B	16.4s	B
KY-A	W 9th & I-75 NB Ramps	AM	260.9s	F	252.7s	F	264.2s	F	N/A	N/A	261.6s	F
		PM	151.7s	F	156.1s	F	153.3s	F	N/A	N/A	153.4s	F



## Alternative D Traffic Data - Ramp Segments

*Data Corresponds With Level of Service Exhibits*

Alternative D I-75 Ramp Junctions					
Ramp Junction	Direction	Ramp Volumes	Peak	Density	LOS
Dixie Highway Diverge	NB	720	AM	-	F
		1100	PM	-	F
Dixie Highway/Kyles Lane Split	NB	280	AM	14.9 pc/mi/ln	B
		380	PM	22.7 pc/mi/ln	C
Dixie Highway Merge	NB	1000	AM	31.9 pc/mi/ln	D
		380	PM	37.7 pc/mi/ln	E
Kyles Lane Merge	NB	1470	AM	29.1 pc/mi/ln	D
		710	PM	29.8 pc/mi/ln	D
Local/W 12th Diverge	NB	2840	AM	29.5 pc/mi/ln	D
		2010	PM	30.9 pc/mi/ln	D
I-71 NB/I-75 NB Split	NB	3620	AM	37.7 pc/mi/ln	E
		2260	PM	-	F
Local Merge	NB	2980	AM	23.7 pc/mi/ln	C
		4410	PM	-	F
Central Pkwy/WHV diverge	NB	1250	AM	28.7 pc/mi/ln	D
		910	PM	35.1 pc/mi/ln	E
WHV/Central Ramps Split	NB	540	AM	25.8 pc/mi/ln	C
		160	PM	18.6 pc/mi/ln	C
Bank/WHV Ramps Merge	NB	270	AM	14.6 pc/mi/ln	B
		540	PM	15.3 pc/mi/ln	B
WHV Merge	NB	1290	AM	26.6 pc/mi/ln	D
		1000	PM	30.5 pc/mi/ln	D
Central Pkwy Merge	NB	510	AM	17.9 pc/mi/ln	B
		230	PM	20.6 pc/mi/ln	C
WHV Diverge	SB	1210	AM	40.9 pc/mi/ln	E
		560	PM	27.7 pc/mi/ln	C
Findlay Diverge	SB	280	AM	31.5 pc/mi/ln	D
		460	PM	25.8 pc/mi/ln	C
Local/I-71 NB Diverge	SB	4430	AM	44.4 pc/mi/ln	E
		3490	PM	26.7 pc/mi/ln	D
I-71 SB Merge	SB	2310	AM	43.9 pc/mi/ln	E
		3170	PM	31.9 pc/mi/ln	D
Local Merge	SB	330	AM	30.5 pc/mi/ln	D
		3030	PM	-	F
W 12th Merge	SB	780	AM	26.0 pc/mi/ln	C
		1460	PM	37.7 pc/mi/ln	E
Kyles Lane Diverge	SB	880	AM	33.0 pc/mi/ln	D
		1820	PM	-	F
Kyles/Dixie Split	SB	690	AM	18.4 pc/mi/ln	C
		1140	PM	38.5 pc/mi/ln	E
Kyles/Dixie Merge	SB	350	AM	11.1 pc/mi/ln	B
		560	PM	25.3 pc/mi/ln	C
Kyles CD/Dixie exit split	SB	190	AM	11.1 pc/mi/ln	B
		680	PM	25.3 pc/mi/ln	C
Kyles CD merge	SB	350	AM	33.0 pc/mi/ln	D
		560	PM	-	F
Dixie Merge	SB	340	AM	21.2 pc/mi/ln	C
		630	PM	31.4 pc/mi/ln	D

Alternative D I-71 Ramp Junctions					
Ramp Junction	Direction	Ramp Volumes	Peak	Density	LOS
W 9th Merge	NB	850	AM	-	F
		400	PM	26.3 pc/mi/ln	C
US 50/I-75 SB Merge	NB	3010	AM	-	F
		2360	PM	26.0 pc/mi/ln	C

## Alternative D Traffic Data - Ramp Segments

*Data Corresponds With Level of Service Exhibits*

Alternative D I-71 Ramp Junctions					
Ramp Junction	Direction	Ramp Volumes	Peak	Density	LOS
US 50 Diverge	NB	2160	AM	-	F
		2510	PM	24.4 pc/mi/l <sub>n</sub>	C
W 2nd Merge	NB	60	AM	-	F
		290	PM	24.2 pc/mi/l <sub>n</sub>	C
W 5th Merge	NB	190	AM	32.6 pc/mi/l <sub>n</sub>	D
		530	PM	21.7 pc/mi/l <sub>n</sub>	C
I-471 Merge	NB	1960	AM	-	F
		1110	PM	29.3 pc/mi/l <sub>n</sub>	D
I-471 Diverge	SB	650	AM	32.3 pc/mi/l <sub>n</sub>	D
		1530	PM	-	F
W 3rd Street Diverge	SB	1460	AM	30.4 pc/mi/l <sub>n</sub>	D
		470	PM	-	F
US 50 Merge	SB	2320	AM	30.2 pc/mi/l <sub>n</sub>	D
		1970	PM	-	F
US 50 WB/I-75 NB diverge	SB	2940	AM	28.2 pc/mi/l <sub>n</sub>	D
		2970	PM	36.6 pc/mi/l <sub>n</sub>	E
Local SB Diverge	SB	190	AM	24.8 pc/mi/l <sub>n</sub>	C
		320	PM	35.4 pc/mi/l <sub>n</sub>	E

Alternative D US 50 Ramp Junctions					
Ramp Junction	Direction	Ramp Volumes	Peak	Density	LOS
Freeman Avenue Diverge	EB	570	AM	27.6 pc/mi/l <sub>n</sub>	D
		140	PM	10.3 pc/mi/l <sub>n</sub>	A
W 5th Diverge	EB	940	AM	21.2 pc/mi/l <sub>n</sub>	C
		910	PM	12.5 pc/mi/l <sub>n</sub>	B
W 2nd Diverge	EB	610	AM	33.9 pc/mi/l <sub>n</sub>	D
		210	PM	22.9 pc/mi/l <sub>n</sub>	C
I-75 Merge	WB	850	AM	17.5 pc/mi/l <sub>n</sub>	B
		830	PM	17.0 pc/mi/l <sub>n</sub>	B
Freeman Avenue Merge	WB	170	AM	7.0 pc/mi/l <sub>n</sub>	A
		470	PM	17.7 pc/mi/l <sub>n</sub>	B

Alternative D I-71/I-75 Connector Ramp Junctions					
Ramp Junction	Direction	Ramp Volumes	Peak	Density	LOS
W 12th Diverge	NB	1140	AM	23.6 pc/mi/l <sub>n</sub>	C
		1200	PM	24.9 pc/mi/l <sub>n</sub>	C
W 9th Merge (KY)	NB	1740	AM	36.5 pc/mi/l <sub>n</sub>	E
		1200	PM	24.7 pc/mi/l <sub>n</sub>	C
W 2nd Diverge	NB	1200	AM	24.6 pc/mi/l <sub>n</sub>	C
		430	PM	14.5 pc/mi/l <sub>n</sub>	B
Local CD Split	NB	420	AM	17.3 pc/mi/l <sub>n</sub>	B
		240	PM	12.7 pc/mi/l <sub>n</sub>	B
US 50 W 5th Diverge	NB	1310	AM	24.8 pc/mi/l <sub>n</sub>	C
		1050	PM	19.7 pc/mi/l <sub>n</sub>	C
W 5th Diverge (OH)	NB	460	AM	24.8 pc/mi/l <sub>n</sub>	C
		220	PM	19.7 pc/mi/l <sub>n</sub>	C
I-71 SB/US 50/I-75 NB Diverge	NB	970	AM	42.9 pc/mi/l <sub>n</sub>	E
		1530	PM	29.3 pc/mi/l <sub>n</sub>	D
Local/I-71 SB Merge	NB	1970	AM	42.9 pc/mi/l <sub>n</sub>	E
		1440	PM	27.1 pc/mi/l <sub>n</sub>	D
W 3rd/W 4th/W 6th St Merge	NB	390	AM	22.8 pc/mi/l <sub>n</sub>	C
		2020	PM	-	F
Local CD Converge	NB	2780	AM	17.7 pc/mi/l <sub>n</sub>	B
		3700	PM	23.4 pc/mi/l <sub>n</sub>	C
John St/W 9th Merge	NB	200	AM	20.9 pc/mi/l <sub>n</sub>	C
		710	PM	25.3 pc/mi/l <sub>n</sub>	C

## Alternative D Traffic Data - Ramp Segments

*Data Corresponds With Level of Service Exhibits*

Alternative D I-71-75 Connector Ramp Junctions					
Ramp Junction	Direction	Ramp Volumes	Peak	Density	LOS
WHV Merge	SB	1520	AM	31.2 pc/mi/l <sub>n</sub>	D
		860	PM	22.1 pc/mi/l <sub>n</sub>	C
Freeman Diverge	SB	770	AM	29.6 pc/mi/l <sub>n</sub>	D
		520	PM	21.3 pc/mi/l <sub>n</sub>	C
W 7th Diverge	SB	1450	AM	30.3 pc/mi/l <sub>n</sub>	D
		190	PM	14.4 pc/mi/l <sub>n</sub>	B
W 5th Diverge	SB	1110	AM	25.8 pc/mi/l <sub>n</sub>	C
		280	PM	23.6 pc/mi/l <sub>n</sub>	C
US 50/I-71 NB Merge	SB	1650	AM	31.4 pc/mi/l <sub>n</sub>	D
		1110	PM	23.6 pc/mi/l <sub>n</sub>	C
W 2nd Diverge	SB	1210	AM	22.5 pc/mi/l <sub>n</sub>	C
		720	PM	33.5 pc/mi/l <sub>n</sub>	D
US 50/W 2nd Merge	SB	610	AM	22.5 pc/mi/l <sub>n</sub>	C
		210	PM	13.5 pc/mi/l <sub>n</sub>	B
W 9th Merge	SB	50	AM	5.1 pc/mi/l <sub>n</sub>	A
		350	PM	-	F
US 50 Merge	SB	670	AM	18.1 pc/mi/l <sub>n</sub>	C
		820	PM	-	F
W 3rd Merge w/ I-71 SB merge	SB	280	AM	9.2 pc/mi/l <sub>n</sub>	A
		1450	PM	35.4 pc/mi/l <sub>n</sub>	E
W 3rd Merge	SB	470	AM	18.1 pc/mi/l <sub>n</sub>	C
		1770	PM	-	F
W 9th Diverge	SB	1080	AM	22.6 pc/mi/l <sub>n</sub>	C
		1630	PM	-	F



## Alternative E Traffic Data - Freeway Segments

*Data Corresponds With Level of Service Exhibits*

Alternative E I-75 Freeway Segments								
Freeway Segment		Direction	Number of Lanes	Peak	Volume	Density	LOS	Volume/ Capacity
From	To							
South of Dixie Highway	Dixie Highway Diverge	NB	3	AM	7160	-	F	1.216
				PM	8280	-	F	1.413
Dixie Highway Diverge	Dixie Highway Merge	NB	3	AM	6440	-	F	1.094
				PM	7180	-	F	1.225
Dixie Highway Merge	Kyles Lane Merge	NB	5	AM	7440	29.1 pc/mi/ln	D	0.758
				PM	7560	29.8 pc/mi/ln	D	0.774
Kyles Lane Merge	W 12th/W 5th Diverge	NB	6	AM	8910	29.1 pc/mi/ln	D	0.757
				PM	8270	27.1 pc/mi/ln	D	0.706
W 12th/W 5th Diverge	I-71 NB Diverge	NB	5	AM	6740	26.1 pc/mi/ln	D	0.680
				PM	6730	26.3 pc/mi/ln	D	0.686
I-71 NB Diverge	W 9th Merge	NB	3	AM	3070	19.8 pc/mi/ln	C	0.517
				PM	4490	29.3 pc/mi/ln	D	0.763
W 9th Merge	US 50/ W 6th Diverge	NB	3	AM	3620	23.4 pc/mi/ln	C	0.609
				PM	4830	31.9 pc/mi/ln	D	0.821
US 50/ W 6th Diverge	I-71 SB Merge	NB	3	AM	2870	18.5 pc/mi/ln	C	0.483
				PM	4100	26.7 pc/mi/ln	D	0.697
I-71 SB Merge	Local CD NB Merge	NB	4	AM	4770	23.1 pc/mi/ln	C	0.602
				PM	5500	26.9 pc/mi/ln	D	0.701
Local CD NB Merge	Freeman Merge	NB	6	AM	5470	17.7 pc/mi/ln	B	0.463
				PM	7930	25.7 pc/mi/ln	C	0.671
Freeman Merge	WHV/Central Pkwy Diverge	NB	6	AM	5980	19.4 pc/mi/ln	C	0.506
				PM	8680	28.2 pc/mi/ln	D	0.734
WHV/Central Pkwy Diverge	WHV Merge	NB	5	AM	4290	16.7 pc/mi/ln	B	0.435
				PM	7290	28.4 pc/mi/ln	D	0.740
WHV Merge	Central Pkwy Merge	NB	6	AM	5720	18.5 pc/mi/ln	C	0.484
				PM	8400	27.2 pc/mi/ln	D	0.710
North of Central Pkwy Merge		NB	6	AM	6220	20.1 pc/mi/ln	C	0.526
				PM	8630	28.0 pc/mi/ln	D	0.730
North of WHV Diverge	WHV Diverge	SB	5	AM	9480	41.2 pc/mi/ln	E	0.962
				PM	7140	27.8 pc/mi/ln	D	0.725
WHV Diverge	Findlay Diverge	SB	5	AM	8190	32.4 pc/mi/ln	D	0.831
				PM	6540	25.4 pc/mi/ln	C	0.664
Findlay Diverge	WHV Merge	SB	5	AM	7540	29.4 pc/mi/ln	D	0.765
				PM	5470	21.3 pc/mi/ln	C	0.555
WHV Merge	Local CD Diverge	SB	6	AM	8900	28.9 pc/mi/ln	D	0.753
				PM	6330	20.5 pc/mi/ln	C	0.535
Local CD Diverge	I-71 NB Diverge	SB	4	AM	4490	21.8 pc/mi/ln	C	0.570
				PM	3710	18.0 pc/mi/ln	C	0.471
I-71 NB Diverge	US 50 EB Merge	SB	3	AM	3420	22.2 pc/mi/ln	C	0.578
				PM	2730	17.7 pc/mi/ln	B	0.462
US 50 EB Merge	W 9th Diverge	SB	3	AM	4060	26.3 pc/mi/ln	D	0.687
				PM	3520	22.8 pc/mi/ln	C	0.595
W 9th Diverge	I-71 SB Merge	SB	3	AM	3600	23.8 pc/mi/ln	C	0.620
				PM	2940	19.3 pc/mi/ln	C	0.504
I-71 SB Merge	W 12th Merge	SB	6	AM	6870	22.7 pc/mi/ln	C	0.592
				PM	9600	32.2 pc/mi/ln	D	0.827
W 12th Merge	Kyles/Dixie Diverge	SB	6	AM	7340	24.5 pc/mi/ln	C	0.638
				PM	10390	36.1 pc/mi/ln	E	0.895
Kyles/Dixie Diverge	Kyles CD Merge	SB	4	AM	6460	33.0 pc/mi/ln	D	0.842
				PM	8570	-	F	1.107
Kyles CD Merge	Dixie Highway Merge	SB	5	AM	6810	27.2 pc/mi/ln	D	0.710
				PM	9130	39.6 pc/mi/ln	E	0.944
South of Dixie Merge		SB	4	AM	7150	38.7 pc/mi/ln	E	0.932
				PM	9760	-	F	1.261

\* Indicates Weave Segment

## Alternative E Traffic Data - Freeway Segments

*Data Corresponds With Level of Service Exhibits*

Alternative E I-71 Freeway Segments								
Freeway Segment		Direction	Number of Lanes	Peak	Volume	Density	LOS	Volume/ Capacity
From	To							
I-75 NB Diverge	W 5th Merge	NB	2	AM	3670	38.6 pc/mi/ln	E	0.931
				PM	2240	21.9 pc/mi/ln	C	0.571
W 5th Merge	US 50/I-75 SB Merge	NB	2	AM	4470	-	F	1.134
				PM	2660	26.0 pc/mi/ln	C	0.678
US 50/I-75 SB Merge	US 50 Diverge	NB	4	AM	7480	40.0 pc/mi/ln	E	0.949
				PM	5020	24.4 pc/mi/ln	C	0.637
US 50 Diverge	W 2nd Merge	NB	2	AM	5320	-	F	1.337
				PM	2510	24.2 pc/mi/ln	C	0.631
W 2nd Merge	W 5th Merge	NB	3	AM	5380	36.5 pc/mi/ln	E	0.901
				PM	2800	18.0 pc/mi/ln	B	0.469
W 5th Merge	I-471 Merge	NB	3	AM	5570	38.7 pc/mi/ln	E	0.933
				PM	3330	21.4 pc/mi/ln	C	0.558
I-471 Merge	Gilbert Merge	NB	3	AM	7530	-	F	1.255
				PM	4440	28.4 pc/mi/ln	D	0.740
North of I-471 Diverge		SB	3	AM	5230	34.7 pc/mi/ln	D	0.872
				PM	6490	-	F	1.082
I-471 Diverge	3rd Street Diverge	SB	3	AM	4580	29.5 pc/mi/ln	D	0.767
				PM	4960	32.4 pc/mi/ln	D	0.831
3rd Street Diverge	US 50 Merge	SB	2	AM	3120	30.2 pc/mi/ln	D	0.784
				PM	4490	-	F	1.128
US 50 Merge	I-75 NB/US 50 Diverge	SB	4	AM	5440	26.5 pc/mi/ln	D	0.690
				PM	6460	31.9 pc/mi/ln	D	0.819
I-75 NB/US 50 Diverge	W 3rd Merge	SB	2	AM	2500	24.3 pc/mi/ln	C	0.634
				PM	3490	36.6 pc/mi/ln	E	0.902
W 3rd Merge	W 9th Diverge	SB	3	AM	2780	18.0 pc/mi/ln	C	0.470
				PM	4940	32.9 pc/mi/ln	D	0.839
W 9th Diverge	W 5th Merge	SB	3	AM	2660	17.6 pc/mi/ln	B	0.458
				PM	4810	32.1 pc/mi/ln	D	0.825
W 5th Merge	I-75 SB Merge	SB	4	AM	3270	16.2 pc/mi/ln	B	0.422
				PM	6660	33.8 pc/mi/ln	D	0.856

Alternative E US 50 Freeway Segments								
Freeway Segment		Direction	Number of Lanes	Peak	Volume	Density	LOS	Volume/ Capacity
From	To							
West of Freeman Avenue Diverge		EB	3	AM	3350	21.2 pc/mi/ln	C	0.553
				PM	1300	8.2 pc/mi/ln	A	0.215
Freeman Avenue Diverge	Freeman Avenue Merge	EB	2	AM	2650	25.1 pc/mi/ln	C	0.656
				PM	1130	10.7 pc/mi/ln	A	0.280
Freeman Avenue Merge	W 6th Street Merge	EB	3	AM	2720	18.89 pc/mi/ln*	B	0.520
				PM	1540	11.39 pc/mi/ln*	B	0.345
W 6th Street Merge	I-75 SB Diverge	EB	4	AM	2940	15.72 pc/mi/ln*	B	0.438
				PM	2290	13.32 pc/mi/ln*	B	0.397
I-75 NB/I-71 SB Merge	Gest Street Diverge	WB	3	AM	1980	12.5 pc/mi/ln	B	0.327
				PM	2960	18.7 pc/mi/ln	C	0.488
Gest Street Diverge	Linn Street Diverge	WB	3	AM	1460	9.2 pc/mi/ln	A	0.241
				PM	2610	16.5 pc/mi/ln	B	0.431
Linn Street Diverge	Freeman Avenue Merge	WB	3	AM	940	5.9 pc/mi/ln	A	0.155
				PM	2360	14.9 pc/mi/ln	B	0.389
West of Freeman Avenue Merge		WB	3	AM	1060	6.7 pc/mi/ln	A	0.175
				PM	2800	17.7 pc/mi/ln	B	0.462

\* Indicates Weave Segment

## Alternative E Traffic Data - Freeway Segments

*Data Corresponds With Level of Service Exhibits*

Alternative E I-71/I-75 Connector Freeway Segments								
Freeway Segment		Direction	Number of Lanes	Peak	Volume	Density	LOS	Volume/Capacity
From	To							
I-75 NB Split	W 12th Diverge	NB	2	AM	2170	20.6 pc/mi/ln	C	0.537
				PM	1540	14.6 pc/mi/ln	B	0.381
W 12th Diverge	W 5th Diverge (KY)	NB	2	AM	1920	18.2 pc/mi/ln	C	0.475
				PM	990	9.4 pc/mi/ln	A	0.245
W 5th Diverge (KY)	W 4th Merge	NB	2	AM	1030	9.8 pc/mi/ln	A	0.255
				PM	340	3.2 pc/mi/ln	A	0.084
W 4th Merge	W 2nd Diverge	NB	2	AM	2270	21.5 pc/mi/ln	C	0.562
				PM	1180	11.2 pc/mi/ln	B	0.292
W 2nd Diverge	W 5th Diverge (OH)	NB	2	AM	1070	10.1 pc/mi/ln	A	0.265
				PM	750	7.1 pc/mi/ln	A	0.186
W 5th Diverge (OH)	W 4th Merge (OH)	NB	1	AM	470	9.0 pc/mi/ln	A	0.235
				PM	460	8.7 pc/mi/ln	A	0.228
W 4th Merge (OH)	W 9th Diverge	NB	2	AM	720	6.9 pc/mi/ln	A	0.180
				PM	2250	21.4 pc/mi/ln	C	0.557
W 9th Diverge	W 6th Merge	NB	2	AM	640	6.1 pc/mi/ln	A	0.160
				PM	2150	20.4 pc/mi/ln	C	0.532
W 6th Merge	Winchell Diverge	NB	3	AM	710	5.63 pc/mi/ln*	A	0.186
				PM	2440	15.67 pc/mi/ln*	B	0.409
Winchell Diverge	I-75 NB Merge	NB	2	AM	700	6.8 pc/mi/ln	A	0.178
				PM	2430	23.0 pc/mi/ln	C	0.599
I-75 SB Diverge	US 50/I-75 NB Split	NB	2	AM	2940	28.2 pc/mi/ln	D	0.735
				PM	2970	28.2 pc/mi/ln	D	0.735
US 50/I-75 NB Split	I-75 NB Merge	NB	1	AM	1900	40.1 pc/mi/ln	E	0.950
				PM	1400	26.3 pc/mi/ln	D	0.687
US 50/I-75 NB Split	US 50 Merge	NB	1	AM	1040	19.9 pc/mi/ln	C	0.520
				PM	1570	30.1 pc/mi/ln	D	0.781
I-75 SB Diverge	Ezzard Charles Merge	SB	3	AM	4410	28.0 pc/mi/ln	D	0.731
				PM	2620	16.6 pc/mi/ln	B	0.432
Ezzard Charles Merge	I-71 NB Diverge	SB	3	AM	4560	29.1 pc/mi/ln	D	0.756
				PM	2880	18.2 pc/mi/ln	C	0.475
I-71 NB Diverge	W 7th Intersection	SB	3	AM	4460	28.4 pc/mi/ln	D	0.740
				PM	2780	17.6 pc/mi/ln	B	0.459
W 7th Intersection	W 5th Diverge	SB	3	AM	3130	19.9 pc/mi/ln	C	0.519
				PM	2790	17.6 pc/mi/ln	B	0.460
W 5th Diverge	W 2nd Diverge	SB	3	AM	1940	12.3 pc/mi/ln	B	0.322
				PM	2450	15.5 pc/mi/ln	B	0.404
W 2nd Diverge	W 4th Merge	SB	2	AM	690	6.6 pc/mi/ln	A	0.172
				PM	1810	17.2 pc/mi/ln	B	0.448
W 4th Merge	W 5th Street intersection	SB	2	AM	800	7.6 pc/mi/ln	A	0.199
				PM	2100	19.9 pc/mi/ln	C	0.520
SB CD Diverge	I-75 SB Merge	SB	1	AM	100	1.9 pc/mi/ln	A	0.050
				PM	100	1.9 pc/mi/ln	A	0.049
I-75 SB Merge	US 50 Merge	SB	1	AM	1170	22.4 pc/mi/ln	C	0.585
				PM	1080	20.4 pc/mi/ln	C	0.532
US 50 Merge	I-71 NB Merge	SB	2	AM	3010	28.6 pc/mi/ln	D	0.745
				PM	2360	22.3 pc/mi/ln	C	0.582

\* Indicates Weave Segment

### Alternative E Traffic Data - Intersections

*Data Corresponds With Level of Service Exhibits*

HCS Results - Signalized Intersections - 2035 Alternative E Volumes												
ID	Intersection	Peak	Eastbound		Westbound		Northbound		Southbound		Overall	
			Delay	LOS	Delay	LOS	Delay	LOS	Delay	LOS	Delay	LOS
OH-1	Bank Street & Dalton Avenue	AM	18.9s	B	20.6s	C	19.3s	B	20.8s	C	20.2s	C
		PM	19.7s	B	24.8s	C	20.7s	C	24.7s	C	23.2s	C
OH-2	Bank Street & Winchell Avenue	AM	11.3s	B	10.9s	B	11.0s	B	N/A	N/A	11.0s	B
		PM	11.6s	B	11.0s	B	11.4s	B	N/A	N/A	11.4s	B
OH-3	Central Pkwy & Linn Street	AM	77.3s	E	8.7s	A	20.5s	C	67.7s	E	57.4s	E
		PM	11.9s	B	164.6s	F	33.1s	C	161.0s	F	111.5s	F
OH-5	Findlay Street & Dalton Avenue	AM	17.5s	B	18.2s	B	18.1s	B	10.7s	B	14.4s	B
		PM	19.2s	B	19.6s	B	19.8s	B	10.6s	B	15.8s	B
OH-6	Findlay Street & Western Avenue	AM	13.7s	B	13.5s	B	N/A	N/A	14.1s	B	13.9s	B
		PM	13.9s	B	13.6s	B	N/A	N/A	14.2s	B	14.1s	B
OH-7	Findlay Street & Winchell Avenue	AM	13.5s	B	13.1s	B	13.6s	B	N/A	N/A	13.6s	B
		PM	13.9s	B	13.5s	B	13.8s	B	N/A	N/A	13.8s	B
OH-8	Liberty Street & Dalton Avenue	AM	11.5s	B	12.1s	B	11.4s	B	11.9s	B	11.7s	B
		PM	12.3s	B	13.6s	B	11.0s	B	13.5s	B	12.7s	B
OH-9	Liberty Street & Western Avenue	AM	11.4s	B	11.0s	B	N/A	N/A	11.5s	B	11.4s	B
		PM	11.6s	B	11.2s	B	N/A	N/A	11.8s	B	11.6s	B
OH-10	Liberty Street & Winchell Avenue	AM	11.2s	B	10.8s	B	11.4s	B	N/A	N/A	11.2s	B
		PM	11.3s	B	11.7s	B	11.4s	B	N/A	N/A	11.4s	B
OH-11	Liberty Street & Linn Street	AM	12.6s	B	12.5s	B	12.4s	B	12.4s	B	12.5s	B
		PM	12.2s	B	13.4s	B	13.0s	B	12.7s	B	13.0s	B
OH-12	Ezzard Charles WB & Western Avenue	AM	N/A	N/A	19.2s	B	N/A	N/A	19.1s	B	19.1s	B
		PM	N/A	N/A	19.5s	B	N/A	N/A	19.8s	B	19.8s	B
OH-13	Ezzard Charles WB & Winchell Avenue	AM	N/A	N/A	11.0s	B	10.8s	B	N/A	N/A	10.8s	B
		PM	N/A	N/A	11.7s	B	11.4s	B	N/A	N/A	11.5s	B
OH-14	Ezzard Charles EB & Western Avenue	AM	18.9s	B	N/A	N/A	N/A	N/A	19.0s	B	19.0s	B
		PM	19.9s	B	N/A	N/A	N/A	N/A	20.1s	C	20.1s	C
OH-15	Ezzard Charles EB & Winchell Avenue	AM	11.4s	B	N/A	N/A	11.4s	B	N/A	N/A	11.4s	B
		PM	11.0s	B	N/A	N/A	10.9s	B	N/A	N/A	10.9s	B
OH-16	Ezzard Charles & Linn Street	AM	13.0s	B	11.4s	B	13.1s	B	12.9s	B	12.8s	B
		PM	12.6s	B	13.4s	B	13.0s	B	12.9s	B	13.0s	B
OH-17	Gest Street & Dalton Avenue	AM	15.3s	B	15.5s	B	15.4s	B	15.7s	B	15.5s	B
		PM	16.8s	B	16.7s	B	13.7s	B	16.7s	B	16.1s	B
OH-18	Gest Street & Western Avenue	AM	15.5s	B	15.1s	B	N/A	N/A	15.4s	B	15.3s	B
		PM	16.0s	B	15.0s	B	N/A	N/A	16.2s	B	16.0s	B
OH-19	Gest Street & Freeman Avenue	AM	13.1s	B	20.2s	C	20.3s	C	N/A	N/A	17.7s	B
		PM	14.9s	B	19.7s	B	19.3s	B	N/A	N/A	17.2s	B
OH-20	Linn/W 3rd Street & Gest Street	AM	15.5s	B	16.9s	B	16.6s	B	9.3s	A	15.2s	B
		PM	16.5s	B	17.4s	B	17.1s	B	9.5s	A	16.0s	B
OH-23	8th Street & Dalton Avenue	AM	12.8s	B	19.6s	B	18.2s	B	19.9s	B	16.7s	B
		PM	12.4s	B	21.2s	C	17.5s	B	21.2s	C	19.4s	B
OH-24	8th Street & Freeman Avenue	AM	24.2s	C	21.5s	C	24.7s	C	21.9s	C	23.4s	C
		PM	22.8s	C	22.7s	C	21.9s	C	23.0s	C	22.7s	C
OH-25	8th Street & Linn Street	AM	22.7s	C	20.0s	B	23.2s	C	20.4s	C	22.1s	C
		PM	24.1s	C	26.4s	C	26.6s	C	18.8s	B	24.5s	C
OH-26	WHV & Spring Grove Avenue	AM	18.7s	B	26.6s	C	16.0s	B	26.2s	C	22.4s	C
		PM	11.7s	B	65.8s	E	68.1s	E	68.9s	E	61.7s	E
OH-27	Dalton Avenue & Linn Street	AM	13.7s	B	14.9s	B	14.5s	B	13.7s	B	14.4s	B
		PM	17.9s	B	11.1s	B	18.2s	B	17.3s	B	16.9s	B
OH-29	W Court Street & Central Avenue	AM	16.2s	B	13.8s	B	16.3s	B	N/A	N/A	15.9s	B
		PM	13.2s	B	13.3s	B	13.2s	B	N/A	N/A	13.2s	B
OH-30	W 9th Street & Central Avenue	AM	N/A	N/A	12.7s	B	12.7s	B	12.1s	B	12.7s	B
		PM	N/A	N/A	13.6s	B	13.4s	B	13.0s	B	13.5s	B
OH-31	W 7th Street & Central Avenue	AM	19.0s	B	N/A	N/A	19.2s	B	N/A	N/A	19.0s	B
		PM	13.6s	B	N/A	N/A	13.6s	B	N/A	N/A	13.6s	B
OH-32	W 6th Street & Central Avenue	AM	24.9s	C	25.2s	C	24.8s	C	N/A	N/A	25.0s	C
		PM	23.9s	C	24.3s	C	24.3s	C	N/A	N/A	24.2s	C
OH-33	W 5th Street & Central Avenue	AM	33.9s	C	N/A	N/A	32.7s	C	31.4s	C	33.2s	C
		PM	26.0s	C	N/A	N/A	25.7s	C	9.2s	A	23.2s	C
OH-34	W 4th Street & Central Avenue	AM	N/A	N/A	18.1s	B	15.2s	B	17.7s	B	17.2s	B
		PM	N/A	N/A	46.5s	D	42.6s	D	40.3s	D	44.4s	D
OH-35	W 3rd Street & Central Avenue	AM	42.8s	D	43.3s	D	30.4s	C	43.6s	D	42.5s	D
		PM	38.5s	D	38.4s	D	35.7s	D	39.0s	D	37.3s	D
OH-36	W 4th Street & Plum Street	AM	N/A	N/A	13.0s	B	N/A	N/A	12.9s	B	13.0s	B
		PM	N/A	N/A	15.6s	B	N/A	N/A	15.7s	B	15.6s	B
OH-37	W 3rd Street & Plum Street	AM	N/A	N/A	13.1s	B	N/A	N/A	13.4s	B	13.2s	B
		PM	N/A	N/A	13.2s	B	N/A	N/A	13.2s	B	13.2s	B
OH-38	W 4th Street & Elm Street	AM	N/A	N/A	14.1s	B	13.9s	B	N/A	N/A	14.0s	B
		PM	N/A	N/A	15.8s	B	16.2s	B	N/A	N/A	15.9s	B

### Alternative E Traffic Data - Intersections

*Data Corresponds With Level of Service Exhibits*

HCS Results - Signalized Intersections - 2035 Alternative E Volumes												
ID	Intersection	Peak	Eastbound		Westbound		Northbound		Southbound		Overall	
			Delay	LOS	Delay	LOS	Delay	LOS	Delay	LOS	Delay	LOS
OH-39	W 3rd Street & Elm Street	AM	N/A	N/A	14.4s	B	14.1s	B	N/A	N/A	14.3s	B
		PM	N/A	N/A	15.3s	B	15.0s	B	N/A	N/A	15.3s	B
OH-40	W 2nd Street & Elm Street	AM	16.3s	B	N/A	N/A	16.3s	B	N/A	N/A	16.3s	B
		PM	15.1s	B	N/A	N/A	14.7s	B	N/A	N/A	15.0s	B
OH-41	W 3rd Street & Clay Wade Bailey Bridge	AM	17.6s	B	18.0s	B	17.5s	B	N/A	N/A	17.6s	B
		PM	24.9s	C	23.4s	C	24.6s	C	N/A	N/A	24.1s	C
OH-42	WHV & I-75 NB Ramps	AM	19.6s	B	N/A	N/A	20.1s	C	N/A	N/A	19.9s	B
		PM	19.8s	B	N/A	N/A	19.7s	B	N/A	N/A	19.8s	B
OH-43	W McMillan Street & Central Pkwy	AM	26.0s	C	21.8s	C	24.0s	C	25.5s	C	25.3s	C
		PM	19.1s	B	76.0s	E	76.4s	E	75.2s	E	65.4s	E
OH-44	W McMillan Street & W McMicken Avenue	AM	17.5s	B	7.1s	A	16.2s	B	17.3s	B	15.7s	B
		PM	17.4s	B	9.4s	A	15.0s	B	17.0s	B	13.5s	B
OH-47	W McMillan Street/Fairview Avenue/Ravine Street	AM	See Below									
		PM	See Below									
OH-50	I-75 NB Ramps & Central Pkwy	AM	32.3s	C	N/A	N/A	32.4s	C	32.6s	C	32.5s	C
		PM	20.5s	C	N/A	N/A	18.5s	B	20.8s	C	19.5s	B
OH-51	WHV & I-75 SB Ramps	AM	11.1s	B	36.6s	D	N/A	N/A	40.9s	D	23.2s	C
		PM	9.3s	A	21.8s	C	N/A	N/A	22.7s	C	18.4s	B
OH-55	US 50/W 6th & I-71/I-75 Ramp	AM	14.5s	B	20.1s	C	19.1s	B	N/A	N/A	18.3s	B
		PM	15.5s	B	25.9s	C	25.7s	C	N/A	N/A	24.8s	C
OH-56	W 7th/8th Street & I-71/I-75 SB Connector	AM	215.5s	F	N/A	N/A	N/A	N/A	212.4s	F	215.1s	F
		PM	52.2s	D	N/A	N/A	N/A	N/A	50.6s	D	52.1s	D
KY-2	W 4th Street & Philadelphia Street	AM	N/A	N/A	77.9s	E	10.2s	B	71.7s	E	69.0s	E
		PM	N/A	N/A	19.2s	B	13.7s	B	18.6s	B	18.3s	B
KY-3	W 4th Street & Bakewell Street	AM	N/A	N/A	15.8s	B	14.6s	B	15.5s	B	15.8s	B
		PM	N/A	N/A	14.8s	B	14.9s	B	15.0s	B	14.8s	B
KY-4	W 4th Street & Main Street	AM	N/A	N/A	17.9s	B	17.6s	B	12.9s	B	17.0s	B
		PM	N/A	N/A	31.6s	C	8.5s	A	31.0s	C	29.1s	C
KY-7	W 5th Street & Philadelphia Street	AM	18.0s	B	N/A	N/A	17.2s	B	18.3s	B	18.0s	B
		PM	18.4s	B	N/A	N/A	14.2s	B	18.2s	B	17.8s	B
KY-9	W 5th Street & Main Street	AM	20.1s	C	N/A	N/A	20.5s	C	15.8s	B	19.9s	B
		PM	49.3s	D	N/A	N/A	9.5s	A	44.6s	D	43.2s	D
KY-10	Pike Street & Bullock Street	AM	24.1s	C	13.9s	B	N/A	N/A	23.7s	C	21.4s	C
		PM	23.8s	C	25.0s	C	N/A	N/A	25.7s	C	25.4s	C
KY-11	Pike Street & Jillians Way	AM	20.1s	C	15.8s	B	20.1s	C	N/A	N/A	19.2s	B
		PM	15.9s	B	19.0s	B	18.6s	B	N/A	N/A	18.3s	B
KY-14	Dixie Hwy & Kyles Lane	AM	140.3s	F	157.3s	F	148.8s	F	28.5s	C	145.5s	F
		PM	108.0s	F	102.4s	F	106.5s	F	21.0s	C	103.8s	F
KY-15	I-75 SB Ramps & Kyles Lane	AM	N/A	N/A	23.3s	C	14.6s	B	23.6s	C	20.3s	C
		PM	N/A	N/A	62.8s	E	35.1s	D	59.5s	E	52.0s	D
KY-16	I-75 NB Ramps & Kyles Lane	AM	141.0s	F	N/A	N/A	143.5s	F	5.8s	A	95.3s	F
		PM	29.8s	C	N/A	N/A	31.1s	C	15.5s	B	24.3s	C
KY-17	Highland Avenue & Kyles Lane	AM	186.5s	F	20.0s (-)	B	175.9s	F	27.4s	C	134.1s	F
		PM	88.1s	F	224.8s	F	211.4s	F	37.3s	D	167.2s	F
KY-18	I-75 SB Ramps & Dixie Hwy	AM	N/A	N/A	18.0s	B	17.6s	B	17.6s	B	17.7s	B
		PM	N/A	N/A	25.1s	C	8.1s	A	24.4s	C	19.9s	B
KY-19	I-75 NB Ramps & Dixie Hwy	AM	27.1s	C	N/A	N/A	26.3s	C	9.2s	A	21.9s	C
		PM	18.7s	B	N/A	N/A	18.7s	B	14.7s	B	16.4s	B
KY-A	W 9th & I-75 NB Ramps	AM	31.9s	C	31.0s	C	31.1s	C	N/A	N/A	31.3s	C
		PM	33.0s	C	32.5s	C	33.1s	C	N/A	N/A	32.8s	C
KY-B	W 9th & I-75 SB Ramps	AM	30.9s	C	30.7s	C	N/A	N/A	30.2s	C	30.5s	C
		PM	40.0s	D	38.4s	D	N/A	N/A	39.3s	D	39.2s	D
KY-C	W 5h & I-75 NB Ramps	AM	25.6s	C	N/A	N/A	27.1s	C	N/A	N/A	26.3s	C
		PM	17.8s	B	N/A	N/A	18.2s	B	N/A	N/A	18.0s	B
KY-D	W 5th & Local CD SB	AM	18.5s	B	9.2s	A	N/A	N/A	18.9s	B	18.4s	B
		PM	28.2s	C	14.0s	B	N/A	N/A	27.7s	C	27.4s	C
KY-E	W 4th & I-75 NB Ramps	AM	N/A	N/A	14.8s	B	14.5s	B	N/A	N/A	14.8s	B
		PM	N/A	N/A	14.3s	B	14.3s	B	N/A	N/A	14.3s	B

ID	Intersection	Peak	Eastbound		Westbound		Northbound		Southbound		Northeastbound	
			Delay	LOS	Delay	LOS	Delay	LOS	Delay	LOS	Delay	LOS
OH-47	W McMillan Street/Fairview Avenue/Ravine Street	AM	19.0s	B	12.5s	B	33.4s	C	25.8s	C	37.7s	D
		PM	23.2s	C	28.0s	C	26.8s	C	17.7s	B	36.0s	D
			Southwestbound		Overall							
			Delay	LOS	Delay	LOS						
			35.4s	D	21.0s	C						
			43.5s	D	28.7s	C						

### Alternative E Traffic Data - Intersections

*Data Corresponds With Level of Service Exhibits*

HCS Results - Unsignalized Intersections - 2035 Alternative E Volumes												
ID	Intersection	Peak	Eastbound		Westbound		Northbound		Southbound		Overall	
			Delay	LOS	Delay	LOS	Delay	LOS	Delay	LOS	Delay	LOS
OH-4	Bank Street & Linn Street	AM	12.7s	B	N/A	N/A	7.8s [L]	A	N/A	N/A	N/A	N/A
		PM	21.4s	C	N/A	N/A	8.5s [L]	A	N/A	N/A	N/A	N/A
OH-21	Court Street & Linn Street	AM	12.2s	B	14.7s	B	7.8s [L]	A	8.2s [L]	A	N/A	N/A
		PM	15.5s	C	24.6s	C	8.6s [L]	A	8.5s [L]	A	N/A	N/A
OH-28	W 6th Street & Linn Street	AM	N/A	N/A	N/A	N/A	N/A	N/A	8.9s [L]	A	N/A	N/A
		PM	N/A	N/A	N/A	N/A	N/A	N/A	28.7s	D	N/A	N/A
OH-45	Clemmer Avenue & W McMillan Street	AM	N/A	N/A	14.1s	B	N/A	N/A	7.8s [L]	A	N/A	N/A
		PM	N/A	N/A	20.7s	C	N/A	N/A	9.4s [L]	A	N/A	N/A
OH-46	W McMillan Street & Scenic Drive	AM	N/A	N/A	N/A	N/A	9.8s [L]	A	N/A	N/A	N/A	N/A
		PM	N/A	N/A	N/A	N/A	8.3s [L]	A	N/A	N/A	N/A	N/A
OH-48	W McMillan Street & Flora Avenue	AM	N/A	N/A	9.5s [L]	A	10.9s	B	N/A	N/A	N/A	N/A
		PM	N/A	N/A	8.5s [L]	A	9.9s	A	N/A	N/A	N/A	N/A
OH-49	W McMillan Street & Victor Avenue	AM	N/A	N/A	9.5s [L]	A	15.4s	C	N/A	N/A	N/A	N/A
		PM	N/A	N/A	8.5s [L]	A	13.7s	B	N/A	N/A	N/A	N/A
KY-1	W 4th Street & Crescent Avenue	AM	N/A	N/A	615.4s	F	N/A	N/A	N/A	N/A	N/A	N/A
		PM	N/A	N/A	559.9s	F	N/A	N/A	N/A	N/A	N/A	N/A
KY-6	W 5th Street & Crescent Avenue	AM	N/A	N/A	4867s	F	N/A	N/A	33.2s [L]	D	N/A	N/A
		PM	N/A	N/A	1233s	F	N/A	N/A	15.8s [L]	C	N/A	N/A
KY-8	W 5th Street & Bakewell Street	AM	7.3s [L]	A	N/A	N/A	35.1s	E	72.0s	F	N/A	N/A
		PM	7.3s [L]	A	N/A	N/A	234.0s	F	-	F	N/A	N/A
KY-12	W 12th Street & Bullock Street	AM	14.76s	B	15.79s	C	N/A	N/A	17.58s	C	16.60s	C
		PM	11.27s	B	19.50s	C	N/A	N/A	36.38s	E	30.73s	D
KY-13	W 12th Street & Jillians Way	AM	104.24s	F	109.55s	F	16.80s	C	N/A	N/A	92.29s	F
		PM	112.90s	F	155.76s	F	82.97s	F	N/A	N/A	118.45s	F

## Alternative E Traffic Data - Ramp Segments

*Data Corresponds With Level of Service Exhibits*

Alternative E I-75 Ramp Junctions					
Ramp Junction	Direction	Ramp Volumes	Peak	Density	LOS
Dixie Highway Diverge	NB	720	AM	-	F
		1100	PM	-	F
Dixie Highway/Kyles Lane Split	NB	280	AM	14.9 pc/mi/ln	B
		380	PM	22.7 pc/mi/ln	C
Dixie Highway Merge	NB	1000	AM	-	F
		380	PM	-	F
Kyles Lane Merge	NB	1470	AM	29.1 pc/mi/ln	C
		710	PM	29.8 pc/mi/ln	D
W 12th Diverge	NB	2170	AM	29.1 pc/mi/ln	D
		1540	PM	27.1 pc/mi/ln	D
I-71 NB/I-75 NB Split	NB	3670	AM	38.6 pc/mi/ln	E
		2240	PM	29.3 pc/mi/ln	D
W 9th Merge	NB	550	AM	23.7 pc/mi/ln	C
		340	PM	29.7 pc/mi/ln	D
US 50/6th Diverge	NB	750	AM	26.8 pc/mi/ln	C
		730	PM	33.0 pc/mi/ln	D
I-71 SB Merge	NB	1900	AM	39.7 pc/mi/ln	E
		1400	PM	26.9 pc/mi/ln	D
Local CD Merge	NB	700	AM	23.1 pc/mi/ln	C
		2430	PM	26.9 pc/mi/ln	D
Freeman Merge	NB	510	AM	21.8 pc/mi/ln	C
		750	PM	27.8 pc/mi/ln	C
Central Pkwy/WHV diverge	NB	1690	AM	35.0 pc/mi/ln	D
		1390	PM	28.4 pc/mi/ln	D
Central Pkwy/WHV Ramp Split	NB	540	AM	35.0 pc/mi/ln	D
		160	PM	28.4 pc/mi/ln	D
WHV/Bank Ramps Merge	NB	220	AM	23.7 pc/mi/ln	C
		440	PM	25.1 pc/mi/ln	C
Bank/WHV Merge	NB	1430	AM	29.5 pc/mi/ln	D
		1110	PM	28.4 pc/mi/ln	D
Central Pkwy Merge	NB	500	AM	17.2 pc/mi/ln	B
		230	PM	19.9 pc/mi/ln	B
WHV Diverge	SB	1290	AM	34.6 pc/mi/ln	D
		600	PM	24.7 pc/mi/ln	C
Findlay Diverge	SB	650	AM	32.0 pc/mi/ln	D
		800	PM	27.2 pc/mi/ln	C
WHV Merge	SB	1360	AM	29.4 pc/mi/ln	D
		590	PM	21.3 pc/mi/ln	C
Local CD Diverge	SB	4410	AM	28.9 pc/mi/ln	D
		2620	PM	20.5 pc/mi/ln	C
I-71 NB Diverge	SB	1070	AM	22.2 pc/mi/ln	C
		980	PM	18.5 pc/mi/ln	C
US 50 Merge	SB	640	AM	26.2 pc/mi/ln	C
		790	PM	23.6 pc/mi/ln	C
W 9th Diverge	SB	460	AM	26.0 pc/mi/ln	C
		580	PM	23.4 pc/mi/ln	C
I-71 SB Merge	SB	3270	AM	23.8 pc/mi/ln	C
		6660	PM	33.8 pc/mi/ln	D
W 12th Merge	SB	470	AM	21.1 pc/mi/ln	C
		790	PM	30.1 pc/mi/ln	D
Kyles Lane Diverge	SB	880	AM	33.0 pc/mi/ln	D
		1820	PM	-	F
Kyles/Dixie Split	SB	690	AM	18.4 pc/mi/ln	C
		1140	PM	38.5 pc/mi/ln	E
Kyles/Dixie Merge	SB	350	AM	11.1 pc/mi/ln	B
		560	PM	25.3 pc/mi/ln	C

## Alternative E Traffic Data - Ramp Segments

*Data Corresponds With Level of Service Exhibits*

Alternative E I-75 Ramp Junctions					
Ramp Junction	Direction	Ramp Volumes	Peak	Density	LOS
Kyles CD/Dixie exit split	SB	190	AM	11.1 pc/mi/ln	B
		680	PM	25.3 pc/mi/ln	C
Kyles CD merge	SB	350	AM	33.0 pc/mi/ln	D
		560	PM	-	F
Dixie Merge	SB	340	AM	21.2 pc/mi/ln	C
		630	PM	31.4 pc/mi/ln	D

Alternative E I-71 Ramp Junctions					
Ramp Junction	Direction	Ramp Volumes	Peak	Density	LOS
W 5th Merge (KY)	NB	800	AM	-	F
		420	PM	24.7 pc/mi/ln	C
US 50/I-75 SB Merge	NB	3010	AM	-	F
		2360	PM	26.0 pc/mi/ln	C
US 50 Diverge	NB	2160	AM	-	F
		2510	PM	24.4 pc/mi/ln	C
W 2nd Merge	NB	60	AM	-	F
		290	PM	24.2 pc/mi/ln	C
W 5th Merge	NB	190	AM	32.6 pc/mi/ln	D
		530	PM	21.7 pc/mi/ln	C
I-471 Merge	NB	1960	AM	-	F
		1110	PM	29.3 pc/mi/ln	D
I-471 Diverge	SB	650	AM	32.3 pc/mi/ln	D
		1530	PM	-	F
W 3rd Street Diverge	SB	1460	AM	30.4 pc/mi/ln	D
		470	PM	-	F
US 50 Merge	SB	2320	AM	30.2 pc/mi/ln	D
		1970	PM	-	F
US 50 WB/I-75 NB diverge	SB	2940	AM	28.2 pc/mi/ln	D
		2970	PM	36.6 pc/mi/ln	E
3rd Merge	SB	280	AM	24.3 pc/mi/ln	C
		1450	PM	36.6 pc/mi/ln	E
W 9th Diverge	SB	120	AM	18.4 pc/mi/ln	B
		130	PM	30.1 pc/mi/ln	D
W 5th Merge (KY)	SB	610	AM	17.6 pc/mi/ln	B
		1850	PM	38.9 pc/mi/ln	E

Alternative E US 50 Ramp Junctions					
Ramp Junction	Direction	Ramp Volumes	Peak	Density	LOS
Freeman Avenue Diverge	EB	700	AM	25.1 pc/mi/ln	C
		170	PM	10.7 pc/mi/ln	A
Gest Diverge	WB	520	AM	18.1 pc/mi/ln	B
		350	PM	23.7 pc/mi/ln	C
Linn Diverge	WB	520	AM	13.0 pc/mi/ln	B
		250	PM	19.6 pc/mi/ln	B
Freeman Avenue Merge	WB	120	AM	6.6 pc/mi/ln	A
		440	PM	16.7 pc/mi/ln	B

Alternative E I-71/I-75 Connector Ramp Junctions					
Ramp Junction	Direction	Ramp Volumes	Peak	Density	LOS
W 12th Diverge	NB	250	AM	23.7 pc/mi/ln	C
		550	PM	17.5 pc/mi/ln	B
W 5th Diverge (KY)	NB	890	AM	18.6 pc/mi/ln	B
		650	PM	9.5 pc/mi/ln	A
W 4th Merge (KY)	NB	1240	AM	22.0 pc/mi/ln	C
		840	PM	12.5 pc/mi/ln	B



## Alternative E Traffic Data - Ramp Segments

*Data Corresponds With Level of Service Exhibits*

Alternative E I-71/I-75 Connector Ramp Junctions					
Ramp Junction	Direction	Ramp Volumes	Peak	Density	LOS
W 2nd Diverge (OH)	NB	1200	AM	22.0 pc/mi/ln	C
		430	PM	11.3 pc/mi/ln	B
W 5th Diverge (OH)	NB	600	AM	12.2 pc/mi/ln	B
		290	PM	8.7 pc/mi/ln	A
W 4th Merge (OH)	NB	250	AM	9.0 pc/mi/ln	A
		1790	PM	37.6 pc/mi/ln	E
W 9th Diverge (OH)	NB	80	AM	7.3 pc/mi/ln	A
		100	PM	22.2 pc/mi/ln	C
US 50/I-75 NB from I-71 SB split	NB	1040	AM	39.7 pc/mi/ln	E
		1570	PM	30.1 pc/mi/ln	D
I-71 SB/I-75 NB to US 50 merge	NB	750	AM	19.9 pc/mi/ln	C
		730	PM	30.1 pc/mi/ln	D
Ezzard Charles Merge	SB	150	AM	28.5 pc/mi/ln	D
		260	PM	20.0 pc/mi/ln	C
I-71 NB Diverge	SB	100	AM	28.1 pc/mi/ln	D
		100	PM	19.1 pc/mi/ln	B
I-75 SB to I-71 NB ramps Merge	SB	1070	AM	22.4 pc/mi/ln	C
		980	PM	20.4 pc/mi/ln	C
I-71 NB/US 50 EB ramp Merge	SB	1840	AM	36.6 pc/mi/ln	E
		1280	PM	24.2 pc/mi/ln	C
W 5th Diverge (OH)	SB	1190	AM	26.9 pc/mi/ln	C
		340	PM	22.6 pc/mi/ln	C
W 2nd Diverge (OH)	SB	1250	AM	12.7 pc/mi/ln	B
		640	PM	17.2 pc/mi/ln	B
W 4th Merge (OH)	SB	110	AM	10.7 pc/mi/ln	B
		290	PM	22.1 pc/mi/ln	C

## Alternative G Traffic Data - Freeway Segments

*Data Corresponds With Level of Service Exhibits*

Alternative G I-75 Freeway Segments								
Freeway Segment		Direction	Number of Lanes	Peak	Volume	Density	LOS	Volume/Capacity
From	To							
South of Dixie Highway	Dixie Highway Diverge	NB	3	AM	7160	-	F	1.216
				PM	8280	-	F	1.413
Dixie Highway Diverge	Dixie Highway Merge	NB	3	AM	6440	-	F	1.094
				PM	7180	-	F	1.225
Dixie Highway Merge	Kyles Lane Merge	NB	5	AM	7440	29.1 pc/mi/ln	D	0.758
				PM	7560	29.8 pc/mi/ln	D	0.774
Kyles Lane Merge	W 12th/W 5th Diverge	NB	6	AM	8910	29.1 pc/mi/ln	D	0.757
				PM	8270	27.1 pc/mi/ln	D	0.706
W 12th/W 5th Diverge	I-71 Diverge	NB	4	AM	5640	27.3 pc/mi/ln	D	0.712
				PM	6240	30.7 pc/mi/ln	D	0.795
I-71 Diverge	Local NB Merge	NB	2	AM	2450	23.7 pc/mi/ln	C	0.618
				PM	4000	-	F	1.019
Local NB Merge	Ezzard Charles Merge	NB	5	AM	4180	16.3 pc/mi/ln	B	0.424
				PM	6580	25.6 pc/mi/ln	C	0.668
Ezzard Charles Merge	Bank/WHV Merge	NB	5	AM	4770	18.5 pc/mi/ln	C	0.484
				PM	8230	32.6 pc/mi/ln	D	0.835
Bank/WHV Merge	Central Pkwy Merge	NB	6	AM	6130	19.9 pc/mi/ln	C	0.518
				PM	9100	29.6 pc/mi/ln	D	0.769
North of Central Pkwy Merge		NB	6	AM	6520	21.1 pc/mi/ln	C	0.551
				PM	9280	30.2 pc/mi/ln	D	0.785
North of WHV Diverge	WHV Diverge	SB	5	AM	9820	44.6 pc/mi/ln	E	0.996
				PM	7290	28.4 pc/mi/ln	D	0.740
WHV Diverge	I-71 NB/Local Diverge	SB	5	AM	8710	35.4 pc/mi/ln	E	0.884
				PM	6780	26.4 pc/mi/ln	D	0.688
I-71 NB/Local Diverge	I-71 SB Merge	SB	2	AM	3920	44.4 pc/mi/ln	E	0.994
				PM	2730	26.7 pc/mi/ln	D	0.696
I-71 SB Merge	Local CD Merge	SB	4	AM	6230	30.5 pc/mi/ln	D	0.790
				PM	5900	29.2 pc/mi/ln	D	0.759
Local CD Merge	W 12th Merge	SB	5	AM	6560	26.0 pc/mi/ln	C	0.678
				PM	8930	37.7 pc/mi/ln	E	0.919
W 12th Merge	Kyles/Dixie Diverge	SB	6	AM	7340	24.5 pc/mi/ln	C	0.638
				PM	10390	36.1 pc/mi/ln	E	0.895
Kyles/Dixie Diverge	Kyles Merge	SB	4	AM	6460	33.0 pc/mi/ln	D	0.842
				PM	8570	-	F	1.107
Kyles Merge	Dixie Merge	SB	5	AM	6810	27.2 pc/mi/ln	D	0.710
				PM	9130	39.6 pc/mi/ln	E	0.944
South of Dixie/Kyles Merge		SB	4	AM	7150	38.7 pc/mi/ln	E	0.932
				PM	9760	-	F	1.261

Alternative G I-71 Freeway Segments								
Freeway Segment		Direction	Number of Lanes	Peak	Volume	Density	LOS	Volume/Capacity
From	To							
I-75 NB Diverge	W 9th/Local Merge	NB	2	AM	3190	31.4 pc/mi/ln	D	0.809
				PM	2240	21.9 pc/mi/ln	C	0.571
W 9th/Local Merge	US 50/I-75 SB Merge	NB	2	AM	3690	39.0 pc/mi/ln	E	0.936
				PM	2380	23.3 pc/mi/ln	C	0.607
US 50/I-75 SB Merge	NB Local Ramps Merge	NB	4	AM	6700	33.4 pc/mi/ln	D	0.850
				PM	4740	23.0 pc/mi/ln	C	0.601
NB Local Ramps Merge	US 50 Diverge	NB	4	AM	7480	40.0 pc/mi/ln	E	0.949
				PM	5020	24.2 pc/mi/ln	C	0.631
US 50 Diverge	W 2nd Merge	NB	2	AM	5320	-	F	1.337
				PM	2510	24.2 pc/mi/ln	C	0.631
W 2nd Merge	W 5th Merge	NB	3	AM	5380	36.5 pc/mi/ln	E	0.901
				PM	2800	18.0 pc/mi/ln	B	0.469

\* Indicates Weave Segment

## Alternative G Traffic Data - Freeway Segments

*Data Corresponds With Level of Service Exhibits*

Alternative G I-71 Freeway Segments								
Freeway Segment		Direction	Number of Lanes	Peak	Volume	Density	LOS	Volume/Capacity
From	To							
W 5th Merge	I-471 Merge	NB	3	AM	5570	38.7 pc/mi/ln	E	0.933
				PM	3330	21.4 pc/mi/ln	C	0.558
I-471 Merge	Gilbert Merge	NB	3	AM	7530	-	F	1.255
				PM	4440	28.4 pc/mi/ln	D	0.740
North of I-471 Diverge		SB	3	AM	5230	34.7 pc/mi/ln	D	0.872
				PM	6490	-	F	1.082
I-471 Diverge	3rd Street Diverge	SB	2	AM	4580	-	F	1.151
				PM	4960	-	F	1.246
3rd Street Diverge	US 50 Merge	SB	2	AM	3120	30.2 pc/mi/ln	D	0.784
				PM	4490	-	F	1.128
US 50 Merge	I-75 NB Diverge	SB	4	AM	5440	26.5 pc/mi/ln	D	0.690
				PM	6460	31.5 pc/mi/ln	D	0.812
I-75 NB Diverge	SR Local Diverge	SB	2	AM	2500	24.3 pc/mi/ln	C	0.634
				PM	3490	36.6 pc/mi/ln	E	0.902
SB Local Diverge	I-75 SB Merge	SB	2	AM	2310	22.5 pc/mi/ln	C	0.586
				PM	3170	31.9 pc/mi/ln	D	0.819

Alternative G US 50 Freeway Segments								
Freeway Segment		Direction	Number of Lanes	Peak	Volume	Density	LOS	Volume/Capacity
From	To							
West of Freeman Avenue Diverge		EB	3	AM	3830	24.1 pc/mi/ln	C	0.629
				PM	1250	7.9 pc/mi/ln	A	0.205
Freeman Avenue Diverge	Freeman Avenue Merge	EB	2	AM	3080	29.2 pc/mi/ln	D	0.759
				PM	1070	10.1 pc/mi/ln	A	0.264
Freeman Avenue Merge	W 6th Street Merge	EB	3	AM	3140	21.98 pc/mi/ln*	C	0.584
				PM	1520	11.30 pc/mi/ln*	B	0.344
W 6th Street Merge	SB CD/local ramps/I-71 NB Diverge	EB	4	AM	3360	17.98 pc/mi/ln*	B	0.488
				PM	2280	13.26 pc/mi/ln*	B	0.396
East of I-75 NB Merge		WB	2	AM	170	1.7 pc/mi/ln	A	0.044
				PM	790	7.5 pc/mi/ln	A	0.195
I-75 NB Merge	Linn Street Diverge	WB	4	AM	1330	6.61 pc/mi/ln*	A	0.204
				PM	2650	13.38 pc/mi/ln*	B	0.371
Linn Street Diverge	Freeman Avenue Merge	WB	3	AM	800	5.1 pc/mi/ln	A	0.133
				PM	2440	15.4 pc/mi/ln	B	0.401
West of Freeman Avenue Merge		WB	3	AM	980	6.3 pc/mi/ln	A	0.163
				PM	3010	19.0 pc/mi/ln	C	0.494

Alternative G I-71/I-75 Connector Freeway Segments								
Freeway Segment		Direction	Number of Lanes	Peak	Volume	Density	LOS	Volume/Capacity
From	To							
I-75 NB Split	W 12th Diverge	NB	2	AM	3270	31.4 pc/mi/ln	D	0.809
				PM	2030	19.3 pc/mi/ln	C	0.502
W 12th Diverge	W 5th Diverge	NB	2	AM	3070	29.2 pc/mi/ln	D	0.760
				PM	1590	15.1 pc/mi/ln	B	0.394
W 5th Diverge	Pike Street Merge	NB	1	AM	2130	-	F	1.054
				PM	830	15.8 pc/mi/ln	B	0.411
Pike Street Merge	W 4th Street Merge	NB	2	AM	3070	29.2 pc/mi/ln	D	0.760
				PM	1240	11.8 pc/mi/ln	B	0.307
W 4th Street Merge	I-71 NB Diverge	NB	3	AM	4220	26.7 pc/mi/ln	D	0.696
				PM	2290	14.5 pc/mi/ln	B	0.378
I-71 NB Diverge	W 5th Diverge	NB	2	AM	2240	21.3 pc/mi/ln	C	0.554
				PM	1580	15.0 pc/mi/ln	B	0.391
W 5th Diverge	US 50 Diverge	NB	2	AM	1660	15.8 pc/mi/ln	B	0.411
				PM	1300	12.3 pc/mi/ln	B	0.322
US 50 Diverge	I-71 NB Merge	NB	1	AM	810	15.4 pc/mi/ln	B	0.401
				PM	490	9.3 pc/mi/ln	A	0.243
I-71 NB Merge	Winchell Diverge	NB	2	AM	2940	28.0 pc/mi/ln	D	0.731
				PM	2170	20.6 pc/mi/ln	C	0.537

\* Indicates Weave Segment

## Alternative G Traffic Data - Freeway Segments

*Data Corresponds With Level of Service Exhibits*

Alternative G I-71/I-75 Connector Freeway Segments								
Freeway Segment		Direction	Number of Lanes	Peak	Volume	Density	LOS	Volume/Capacity
From	To							
Winchell Diverge	Local Merge	NB	2	AM	2760	26.3 pc/mi/ln	D	0.687
				PM	1890	17.9 pc/mi/ln	B	0.468
Local Merge	Central Pkwy Diverge	NB	4	AM	3240	15.4 pc/mi/ln	B	0.403
				PM	4020	19.1 pc/mi/ln	C	0.498
Central Pkwy Diverge	I-75 NB Merge	NB	3	AM	1730	11.0 pc/mi/ln	A	0.287
				PM	2580	16.2 pc/mi/ln	B	0.422
I-71 SB Split	I-75 NB Connector Split	NB	2	AM	2940	28.2 pc/mi/ln	D	0.735
				PM	2970	27.9 pc/mi/ln	D	0.728
I-75 NB Connector Split	I-75 NB Connector Merge	NB	1	AM	2130	-	F	1.054
				PM	1680	32.1 pc/mi/ln	D	0.824
I-75 SB Diverge	WHV Merge	SB	3	AM	4790	30.7 pc/mi/ln	D	0.794
				PM	4050	25.6 pc/mi/ln	C	0.668
WHV Merge	Findlay Diverge	SB	4	AM	6350	30.3 pc/mi/ln	D	0.786
				PM	4910	23.3 pc/mi/ln	C	0.608
Findlay Diverge	Freeman Diverge	SB	4	AM	5730	27.2 pc/mi/ln	D	0.709
				PM	4240	20.1 pc/mi/ln	C	0.525
Freeman Diverge	Ezzard Charles Merge	SB	4	AM	4920	23.6 pc/mi/ln	C	0.615
				PM	3660	17.4 pc/mi/ln	B	0.453
Ezzard Charles Merge	W 7th Diverge	SB	5	AM	5100	22.19 pc/mi/ln*	B	0.571
				PM	4050	15.60 pc/mi/ln*	B	0.409
W 7th Diverge	W 2nd/I-71 SB Diverge	SB	4	AM	3730	17.7 pc/mi/ln	B	0.462
				PM	3870	18.4 pc/mi/ln	C	0.479
W 2nd/I-71 SB Diverge	W 3rd/W 5th Diverge	SB	2	AM	850	8.1 pc/mi/ln	A	0.210
				PM	1810	17.2 pc/mi/ln	B	0.448
W 3rd/W 5th Diverge	US 50 Merge	SB	1	AM	180	3.4 pc/mi/ln	A	0.089
				PM	1570	29.9 pc/mi/ln	D	0.777
US 50 Merge	I-71 SB Merge	SB	2	AM	940	9.1 pc/mi/ln	A	0.236
				PM	2890	27.4 pc/mi/ln	D	0.715
I-71 SB Merge	W 5th Diverge	SB	2	AM	1410	13.6 pc/mi/ln	B	0.356
				PM	4660	-	F	1.165
W 5th Diverge	W 9th Diverge	SB	2	AM	760	7.4 pc/mi/ln	A	0.194
				PM	3970	44.2 pc/mi/ln	E	0.993
W 9th Diverge	I-75 SB Merge	SB	1	AM	330	6.5 pc/mi/ln	A	0.171
				PM	3030	-	F	1.559
W 3rd Diverge	CW Bailey Diverge	SB	3	AM	1410	12.41 pc/mi/ln*	B	0.369
				PM	470	3.29 pc/mi/ln*	A	0.120
I-75 SB Connector Split	US 50 Merge	SB	3	AM	2880	18.2 pc/mi/ln	C	0.475
				PM	2060	13.0 pc/mi/ln	B	0.338
US 50 Merge	W 2nd Diverge	SB	3	AM	3400	21.5 pc/mi/ln	C	0.561
				PM	2150	13.5 pc/mi/ln	B	0.353
W 2nd Diverge	US 50 Merge	SB	1	AM	1320	25.3 pc/mi/ln	C	0.660
				PM	1220	23.0 pc/mi/ln	C	0.601
US 50 Merge	I-75 NB Merge	SB	2	AM	3010	28.9 pc/mi/ln	D	0.753
				PM	2360	22.3 pc/mi/ln	C	0.582

\* Indicates Weave Segment

## Alternative G Traffic Data - Intersections

*Data Corresponds With Level of Service Exhibits*

HCS Results - Signalized Intersections - 2035 Alternative G Volumes												
ID	Intersection	Peak	Eastbound		Westbound		Northbound		Southbound		Overall	
			Delay	LOS	Delay	LOS	Delay	LOS	Delay	LOS	Delay	LOS
OH-1	Bank Street & Dalton Avenue	AM	18.9s	B	20.3s	C	19.1s	B	20.4s	C	19.9s	B
		PM	19.2s	B	23.3s	C	20.7s	C	23.1s	C	22.2s	C
OH-2	Bank Street & Winchell Avenue	AM	11.2s	B	10.9s	B	10.8s	B	N/A	N/A	10.9s	B
		PM	11.3s	B	11.1s	B	11.1s	B	N/A	N/A	11.1s	B
OH-3	Central Pkwy & Linn Street	AM	58.2s	E	9.3s	A	18.9s	B	59.9s	E	44.9s	D
		PM	12.5s	B	117.5s	F	20.5s	C	115.7s	F	81.3s	F
OH-5	Findlay Street & Dalton Avenue	AM	17.0s	B	18.1s	B	18.2s	B	10.9s	B	14.6s	B
		PM	18.7s	B	19.1s	B	19.4s	B	10.5s	B	15.6s	B
OH-6	Findlay Street & Western Avenue	AM	13.7s	B	13.6s	B	N/A	N/A	13.6s	B	13.6s	B
		PM	13.7s	B	13.5s	B	N/A	N/A	13.7s	B	13.7s	B
OH-7	Findlay Street & Winchell Avenue	AM	13.5s	B	12.8s	B	13.5s	B	N/A	N/A	13.4s	B
		PM	13.6s	B	13.2s	B	13.6s	B	N/A	N/A	13.6s	B
OH-8	Liberty Street & Dalton Avenue	AM	11.2s	B	12.0s	B	11.7s	B	12.0s	B	11.9s	B
		PM	12.2s	B	13.7s	B	11.0s	B	13.5s	B	12.8s	B
OH-9	Liberty Street & Western Avenue	AM	11.2s	B	10.7s	B	N/A	N/A	11.1s	B	11.0s	B
		PM	11.2s	B	11.0s	B	N/A	N/A	11.1s	B	11.1s	B
OH-10	Liberty Street & Winchell Avenue	AM	11.4s	B	11.2s	B	11.2s	B	N/A	N/A	11.3s	B
		PM	10.7s	B	11.8s	B	11.6s	B	N/A	N/A	11.5s	B
OH-11	Liberty Street & Linn Street	AM	12.8s	B	12.4s	B	12.6s	B	12.5s	B	12.6s	B
		PM	11.8s	B	13.2s	B	13.5s	B	13.1s	B	13.1s	B
OH-12	Ezzard Charles WB & Western Avenue	AM	N/A	N/A	18.7s	B	N/A	N/A	18.7s	B	18.7s	B
		PM	N/A	N/A	18.8s	B	N/A	N/A	18.5s	B	18.5s	B
OH-13	Ezzard Charles WB & Winchell Avenue	AM	N/A	N/A	11.4s	B	11.5s	B	N/A	N/A	11.5s	B
		PM	N/A	N/A	13.8s	B	14.2s	B	N/A	N/A	14.2s	B
OH-14	Ezzard Charles EB & Western Avenue	AM	18.6s	B	N/A	N/A	N/A	N/A	18.6s	B	18.6s	B
		PM	18.7s	B	N/A	N/A	N/A	N/A	18.7s	B	18.7s	B
OH-15	Ezzard Charles EB & Winchell Avenue	AM	11.7s	B	N/A	N/A	11.9s	B	N/A	N/A	11.8s	B
		PM	12.6s	B	N/A	N/A	12.3s	B	N/A	N/A	12.4s	B
OH-16	Ezzard Charles & Linn Street	AM	13.2s	B	12.4s	B	13.2s	B	12.7s	B	13.0s	B
		PM	12.4s	B	13.2s	B	13.3s	B	13.4s	B	13.2s	B
OH-17	Gest Street & Dalton Avenue	AM	15.3s	B	16.0s	B	15.6s	B	15.8s	B	15.7s	B
		PM	16.8s	B	17.0s	B	13.9s	B	17.2s	B	16.5s	B
OH-18	Gest Street & Western Avenue	AM	14.8s	B	15.1s	B	N/A	N/A	15.1s	B	15.0s	B
		PM	15.2s	B	14.3s	B	N/A	N/A	15.0s	B	14.9s	B
OH-19	Gest Street & Freeman Avenue	AM	17.1s	B	25.9s	C	25.5s	C	26.4s	C	24.9s	C
		PM	16.7s	B	24.0s	C	24.1s	C	23.8s	C	22.0s	C
OH-20	Linn/W 3rd Street & Gest Street	AM	15.2s	B	16.6s	B	16.8s	B	9.6s	A	14.9s	B
		PM	16.5s	B	17.3s	B	17.1s	B	9.6s	A	15.9s	B
OH-23	8th Street & Dalton Avenue	AM	12.8s	B	19.7s	B	18.4s	B	19.7s	B	16.8s	B
		PM	12.4s	B	21.2s	C	17.7s	B	21.6s	C	19.6s	B
OH-24	8th Street & Freeman Avenue	AM	24.2s	C	21.7s	C	24.4s	C	21.7s	C	23.4s	C
		PM	23.8s	C	22.9s	C	21.9s	C	23.7s	C	23.2s	C
OH-25	8th Street & Linn Street	AM	21.6s	C	19.2s	B	20.7s	C	21.7s	C	21.2s	C
		PM	23.5s	C	24.0s	C	24.4s	C	21.2s	C	23.2s	C
OH-26	WHV & Spring Grove Avenue	AM	20.0s	B	27.2s	C	18.0s	B	27.9s	C	23.6s	C
		PM	18.3s	B	51.3s	D	29.2s	C	49.8s	D	39.8s	D
OH-27	Dalton Avenue & Linn Street	AM	13.4s	B	14.5s	B	14.7s	B	14.2s	B	14.3s	B
		PM	17.8s	B	10.5s	B	18.1s	B	18.1s	B	17.1s	B
OH-29	W Court Street & Central Avenue	AM	16.1s	B	13.9s	B	16.4s	B	N/A	N/A	16.0s	B
		PM	12.9s	B	13.5s	B	13.5s	B	N/A	N/A	13.4s	B
OH-30	W 9th Street & Central Avenue	AM	N/A	N/A	12.8s	B	12.8s	B	12.2s	B	12.8s	B
		PM	N/A	N/A	15.2s	B	14.8s	B	14.5s	B	15.0s	B
OH-31	W 7th Street & Central Avenue	AM	16.4s	B	N/A	N/A	16.7s	B	N/A	N/A	16.5s	B
		PM	13.6s	B	N/A	N/A	13.5s	B	N/A	N/A	13.5s	B
OH-32	W 6th Street & Central Avenue	AM	N/A	N/A	13.7s	B	13.7s	B	N/A	N/A	13.7s	B
		PM	N/A	N/A	14.9s	B	15.0s	B	N/A	N/A	14.9s	B

### Alternative G Traffic Data - Intersections

*Data Corresponds With Level of Service Exhibits*

HCS Results - Signalized Intersections - 2035 Alternative G Volumes												
ID	Intersection	Peak	Eastbound		Westbound		Northbound		Southbound		Overall	
			Delay	LOS	Delay	LOS	Delay	LOS	Delay	LOS	Delay	LOS
OH-33	W 5th Street & Central Avenue	AM	23.8s	C	N/A	N/A	23.5s	C	18.2s	B	23.5s	C
		PM	19.4s	B	N/A	N/A	19.1s	B	13.3s	B	18.3s	B
OH-34	W 4th Street & Central Avenue	AM	N/A	N/A	17.2s	B	11.6s	B	17.4s	B	16.3s	B
		PM	N/A	N/A	20.2s	C	13.6s	B	20.0s	C	18.6s	B
OH-35	W 3rd Street & Central Avenue	AM	44.1s	D	44.9s	D	43.0s	D	45.0s	D	44.6s	D
		PM	45.4s	D	46.1s	D	45.1s	D	45.3s	D	45.6s	D
OH-36	W 4th Street & Plum Street	AM	N/A	N/A	12.6s	B	N/A	N/A	12.9s	B	12.7s	B
		PM	N/A	N/A	13.9s	B	N/A	N/A	13.8s	B	13.9s	B
OH-37	W 3rd Street & Plum Street	AM	N/A	N/A	13.2s	B	N/A	N/A	13.4s	B	13.2s	B
		PM	N/A	N/A	13.3s	B	N/A	N/A	13.2s	B	13.3s	B
OH-38	W 4th Street & Elm Street	AM	N/A	N/A	13.6s	B	13.4s	B	N/A	N/A	13.5s	B
		PM	N/A	N/A	15.2s	B	15.0s	B	N/A	N/A	15.1s	B
OH-39	W 3rd Street & Elm Street	AM	N/A	N/A	14.4s	B	14.3s	B	N/A	N/A	14.4s	B
		PM	N/A	N/A	15.4s	B	15.1s	B	N/A	N/A	15.4s	B
OH-40	W 2nd Street & Elm Street	AM	15.7s	B	N/A	N/A	16.1s	B	N/A	N/A	15.7s	B
		PM	15.0s	B	N/A	N/A	14.8s	B	N/A	N/A	15.0s	B
OH-41	W 3rd Street & Clay Wade Bailey Bridge	AM	29.4s	C	32.3s	C	32.0s	C	31.8s	C	31.7s	C
		PM	44.4s	D	44.7s	D	44.0s	D	45.1s	D	44.6s	D
OH-42	WHV & I-75 NB Ramps	AM	24.0s	C	N/A	N/A	23.5s	C	N/A	N/A	23.7s	C
		PM	27.1s	C	N/A	N/A	28.2s	C	N/A	N/A	27.9s	C
OH-43	W McMillan Street & Central Pkwy	AM	23.9s	C	22.2s	C	21.9s	C	24.3s	C	23.6s	C
		PM	16.4s	B	44.4s	D	43.1s	D	46.8s	D	38.9s	D
OH-44	W McMillan Street & W McMicken Avenue	AM	17.5s	B	7.1s	A	16.2s	B	17.3s	B	15.5s	B
		PM	16.7s	B	9.4s	A	15.1s	B	17.0s	B	13.3s	B
OH-47	W McMillan Street/Fairview Avenue/Ravine Street	AM	See Below									
		PM										
OH-50	I-75 NB Ramps & Central Pkwy	AM	28.7s	C	N/A	N/A	26.9s	C	28.2s	C	28.0s	C
		PM	20.1s	C	N/A	N/A	15.0s	B	20.0s	C	17.3s	B
OH-51	WHV & I-75 SB Ramps	AM	15.6s	B	42.5s	D	N/A	N/A	42.1s	D	26.1s	C
		PM	5.7s	A	22.8s	C	N/A	N/A	22.2s	C	17.0s	B
KY-2	W 4th Street & Philadelphia Street	AM	N/A	N/A	21.9s	C	10.6s	B	21.6s	C	18.5s	B
		PM	N/A	N/A	22.5s	C	16.2s	B	22.7s	C	20.8s	C
KY-3	W 4th Street & Bakewell Street	AM	N/A	N/A	13.9s	B	13.5s	B	14.2s	B	13.9s	B
		PM	N/A	N/A	14.9s	B	14.7s	B	14.7s	B	14.9s	B
KY-4	W 4th Street & Main Street	AM	N/A	N/A	15.1s	B	15.1s	B	11.6s	B	14.4s	B
		PM	N/A	N/A	37.1s	D	6.7s	A	34.4s	C	33.4s	C
KY-7	W 5th Street & Philadelphia Street	AM	23.4s	C	N/A	N/A	21.9s	C	23.4s	C	23.3s	C
		PM	21.7s	C	N/A	N/A	19.3s	B	22.5s	C	21.6s	C
KY-9	W 5th Street & Main Street	AM	18.2s	B	N/A	N/A	18.6s	B	18.7s	B	18.4s	B
		PM	56.0s	E	N/A	N/A	8.7s	A	51.2s	D	50.0s	D
KY-10	Pike Street & Bullock Street	AM	23.2s	C	16.0s	B	N/A	N/A	23.1s	C	21.5s	C
		PM	33.4s	C	34.9s	C	N/A	N/A	33.3s	C	33.9s	C
KY-11	Pike Street & Jillians Way	AM	21.8s	C	14.7s	B	21.6s	C	N/A	N/A	19.7s	B
		PM	13.9s	B	19.0s	B	19.8s	B	N/A	N/A	18.7s	B
KY-14	Dixie Hwy & Kyles Lane	AM	140.3s	F	157.3s	F	148.8s	F	28.5s	C	145.5s	F
		PM	108.0s	F	102.4s	F	106.5s	F	21.0s	C	103.8s	F
KY-15	I-75 SB Ramps & Kyles Lane	AM	N/A	N/A	23.3s	C	14.6s	B	23.6s	C	20.3s	C
		PM	N/A	N/A	53.7s	D	44.2s	D	59.5s	E	52.1s	D
KY-16	I-75 NB Ramps & Kyles Lane	AM	141.0s	F	N/A	N/A	143.5s	F	5.8s	A	95.3s	F
		PM	29.8s	C	N/A	N/A	31.1s	C	15.5s	B	24.3s	C
KY-17	Highland Avenue & Kyles Lane	AM	186.5s	F	20.0s (-)	B	175.9s	F	27.4s	C	134.1s	F
		PM	88.1s	F	224.8s	F	211.4s	F	37.3s	D	167.2s	F
KY-18	I-75 SB Ramps & Dixie Hwy	AM	N/A	N/A	18.0s	B	17.6s	B	17.6s	B	17.7s	B
		PM	N/A	N/A	25.1s	C	8.1s	A	24.4s	C	19.9s	B
KY-19	I-75 NB Ramps & Dixie Hwy	AM	27.1s	C	N/A	N/A	26.3s	C	9.2s	A	21.9s	C
		PM	18.7s	B	N/A	N/A	18.7s	B	14.7s	B	16.4s	B
KY-A	W 9th & I-75 NB Ramps	AM	118.4s	F	112.5s	F	117.6s	F	N/A	N/A	116.6s	F
		PM	33.7s	C	34.5s	C	35.1s	D	N/A	N/A	34.4s	C

## Alternative G Traffic Data - Intersections

*Data Corresponds With Level of Service Exhibits*

HCS Results - Signalized Intersections - 2035 Alternative G Volumes												
ID	Intersection	Peak	Eastbound		Westbound		Northbound		Southbound		Overall	
			Delay	LOS	Delay	LOS	Delay	LOS	Delay	LOS	Delay	LOS
KY-B	W 9th & I-75 SB Ramps	AM	50.2s	D	51.6s	D	N/A	N/A	53.5s	D	51.8s	D
		PM	44.3s	D	42.9s	D	N/A	N/A	42.4s	D	42.8s	D

ID	Intersection	Peak	Eastbound		Westbound		Northbound		Southbound		Northeastbound	
			Delay	LOS	Delay	LOS	Delay	LOS	Delay	LOS	Delay	LOS
OH-47	W McMillan Street/Fairview Avenue/Ravine Street	AM	18.9s	B	12.4s	B	33.4s	C	25.8s	C	37.7s	D
		PM	22.9s	C	25.9s	C	27.6s	C	19.0s	B	34.2s	C
			Southwestbound		Overall							
			Delay	LOS	Delay	LOS						
			35.4s	D	20.9s	C						
			40.0s	D	27.3s	C						

HCS Results - Unsignalized Intersections - 2035 Alternative G Volumes												
ID	Intersection	Peak	Eastbound		Westbound		Northbound		Southbound		Overall	
			Delay	LOS	Delay	LOS	Delay	LOS	Delay	LOS	Delay	LOS
OH-4	Bank Street & Linn Street	AM	12.0s	B	N/A	N/A	7.7s [L]	A	N/A	N/A	N/A	N/A
		PM	18.8s	C	N/A	N/A	8.2s [L]	A	N/A	N/A	N/A	N/A
OH-21	Court Street & Linn Street	AM	13.9s	B	17.2s	C	8.1s [L]	A	8.6s [L]	A	N/A	N/A
		PM	21.6s	C	42.3s	E	9.1s [L]	A	8.7s [L]	A	N/A	N/A
OH-28	W 6th Street & Linn Street	AM	N/A	N/A	N/A	N/A	N/A	N/A	14.5s [L]	B	N/A	N/A
		PM	N/A	N/A	N/A	N/A	N/A	N/A	14.5s [L]	B	N/A	N/A
OH-45	Clemmer Avenue & W McMillan Street	AM	N/A	N/A	14.4s	B	N/A	N/A	7.9s [L]	A	N/A	N/A
		PM	N/A	N/A	20.9s	C	N/A	N/A	9.4s [L]	A	N/A	N/A
OH-46	W McMillan Street & Scenic Drive	AM	N/A	N/A	N/A	N/A	9.8s [L]	A	N/A	N/A	N/A	N/A
		PM	N/A	N/A	N/A	N/A	8.3s [L]	A	N/A	N/A	N/A	N/A
OH-48	W McMillan Street & Flora Avenue	AM	N/A	N/A	9.5s [L]	A	10.9s	B	N/A	N/A	N/A	N/A
		PM	N/A	N/A	8.5s [L]	A	9.9s	A	N/A	N/A	N/A	N/A
OH-49	W McMillan Street & Victor Avenue	AM	N/A	N/A	9.5s [L]	A	15.3s	C	N/A	N/A	N/A	N/A
		PM	N/A	N/A	8.5s [L]	A	13.7s	B	N/A	N/A	N/A	N/A
KY-1	W 4th Street & Crescent Avenue	AM	N/A	N/A	10.1s	B	N/A	N/A	N/A	N/A	N/A	N/A
		PM	N/A	N/A	11.9s	B	N/A	N/A	N/A	N/A	N/A	N/A
KY-6	W 5th Street & Crescent Avenue	AM	N/A	N/A	N/A	N/A	N/A	N/A	7.5s [L]	A	N/A	N/A
		PM	N/A	N/A	N/A	N/A	N/A	N/A	7.3s [L]	A	N/A	N/A
KY-8	W 5th Street & Bakewell Street	AM	7.3s [L]	A	N/A	N/A	39.4s	E	101.1s	F	N/A	N/A
		PM	7.3s [L]	A	N/A	N/A	33.9s	D	42.0s	E	N/A	N/A
KY-12	W 12th Street & Bullock Street	AM	15.45s	C	25.03s	D	N/A	N/A	49.58s	E	38.86s	E
		PM	11.48s	B	39.98s	E	N/A	N/A	352.48s	F	270.36s	F
KY-13	W 12th Street & Jillians Way	AM	64.27s	F	131.09s	F	14.30s	B	N/A	N/A	90.17s	F
		PM	92.92s	F	218.69s	F	35.63s	E	N/A	N/A	130.85s	F

## Alternative G Traffic Data - Ramp Segments

*Data Corresponds With Level of Service Exhibits*

Alternative G I-75 Ramp Junctions					
Ramp Junction	Direction	Ramp Volumes	Peak	Density	LOS
Dixie Highway Diverge	NB	720	AM	-	F
		1100	PM	-	F
Dixie Highway/Kyles Lane Split	NB	280	AM	14.9 pc/mi/ln	B
		380	PM	22.7 pc/mi/ln	C
Dixie Highway Merge	NB	1000	AM	-	F
		380	PM	-	F
Kyles Lane Merge	NB	1470	AM	29.1 pc/mi/ln	D
		710	PM	29.8 pc/mi/ln	D
Local Lanes Diverge	NB	3270	AM	33.9 pc/mi/ln	D
		2030	PM	30.7 pc/mi/ln	D
Local/W 12th Split	NB	200	AM	34.5 pc/mi/ln	D
		440	PM	22.3 pc/mi/ln	C
I-71 NB/I75 NB Split	NB	3190	AM	31.4 pc/mi/ln	D
		2240	PM	-	F
I-71 NB/Local Merge	NB	1730	AM	23.7 pc/mi/ln	C
		2580	PM	-	F
Ezzard Charles Merge	NB	590	AM	17.0 pc/mi/ln	B
		1650	PM	30.9 pc/mi/ln	D
Bank/WHV Merge	NB	1360	AM	28.0 pc/mi/ln	D
		870	PM	32.6 pc/mi/ln	D
Central Pkwy Merge	NB	390	AM	17.2 pc/mi/ln	B
		180	PM	21.1 pc/mi/ln	C
WHV Diverge	SB	1110	AM	40.3 pc/mi/ln	E
		510	PM	27.6 pc/mi/ln	C
I-71 Diverge	SB	4790	AM	44.4 pc/mi/ln	E
		4050	PM	26.7 pc/mi/ln	D
I-71 Merge	SB	2310	AM	44.4 pc/mi/ln	E
		3170	PM	31.9 pc/mi/ln	D
Local Merge	SB	330	AM	30.5 pc/mi/ln	D
		3030	PM	-	F
W 12th Merge	SB	780	AM	26.0 pc/mi/ln	C
		1460	PM	37.7 pc/mi/ln	E
Kyles Lane Diverge	SB	880	AM	33.0 pc/mi/ln	D
		1820	PM	-	F
Kyles/Dixie Split	SB	690	AM	18.4 pc/mi/ln	C
		1140	PM	38.5 pc/mi/ln	E
Kyles/Dixie Merge	SB	350	AM	11.1 pc/mi/ln	B
		560	PM	25.3 pc/mi/ln	C
Kyles CD/Dixie exit split	SB	190	AM	11.1 pc/mi/ln	B
		680	PM	25.3 pc/mi/ln	C
Kyles CD merge	SB	350	AM	33.0 pc/mi/ln	D
		560	PM	-	F
Dixie Merge	SB	340	AM	21.2 pc/mi/ln	C
		630	PM	31.4 pc/mi/ln	D

Alternative G I-71 Ramp Junctions					
Ramp Junction	Direction	Ramp Volumes	Peak	Density	LOS
W 9th/Pike Merge	NB	500	AM	35.5 pc/mi/ln	E
		140	PM	24.0 pc/mi/ln	C
US 50/I-75 SB Merge	NB	3010	AM	39.0 pc/mi/ln	E
		2360	PM	23.3 pc/mi/ln	C
W 4th/Local Merge	NB	780	AM	33.4 pc/mi/ln	D
		280	PM	21.9 pc/mi/ln	C
US 50 Diverge	NB	2160	AM	-	F
		2510	PM	24.4 pc/mi/ln	C



## Alternative G Traffic Data - Ramp Segments

*Data Corresponds With Level of Service Exhibits*

Alternative G I-71 Ramp Junctions					
Ramp Junction	Direction	Ramp Volumes	Peak	Density	LOS
W 2nd Merge	NB	60	AM	-	F
		290	PM	24.2 pc/mi/l <sub>n</sub>	C
W 5th Merge	NB	190	AM	32.6 pc/mi/l <sub>n</sub>	D
		530	PM	21.7 pc/mi/l <sub>n</sub>	C
I-471 Merge	NB	1960	AM	-	F
		1110	PM	29.3 pc/mi/l <sub>n</sub>	D
I-471 Diverge	SB	650	AM	32.3 pc/mi/l <sub>n</sub>	D
		1530	PM	-	F
W 3rd Street Diverge	SB	1460	AM	30.4 pc/mi/l <sub>n</sub>	D
		470	PM	-	F
US 50 Merge	SB	2320	AM	30.2 pc/mi/l <sub>n</sub>	D
		1970	PM	-	F
Local SB Diverge	SB	190	AM	24.6 pc/mi/l <sub>n</sub>	C
		320	PM	29.6 pc/mi/l <sub>n</sub>	D
I-75 NB Diverge	SB	2940	AM	28.2 pc/mi/l <sub>n</sub>	D
		2970	PM	31.9 pc/mi/l <sub>n</sub>	D

Alternative G US 50 Ramp Junctions					
Ramp Junction	Direction	Ramp Volumes	Peak	Density	LOS
Freeman Avenue Diverge	EB	750	AM	29.2 pc/mi/l <sub>n</sub>	D
		180	PM	10.1 pc/mi/l <sub>n</sub>	A
W 5th Diverge	EB	740	AM	42.9 pc/mi/l <sub>n</sub>	E
		230	PM	25.3 pc/mi/l <sub>n</sub>	C
Gest Street Diverge	WB	500	AM	16.1 pc/mi/l <sub>n</sub>	B
		240	PM	20.3 pc/mi/l <sub>n</sub>	C
Freeman Avenue Merge	WB	180	AM	6.4 pc/mi/l <sub>n</sub>	A
		570	PM	18.2 pc/mi/l <sub>n</sub>	B

Alternative G I-71/I-75 Connector Ramp Junctions					
Ramp Junction	Direction	Ramp Volumes	Peak	Density	LOS
W 5th Diverge	NB	940	AM	-	F
		760	PM	20.4 pc/mi/l <sub>n</sub>	D
W 12th/Pike Merge	NB	940	AM	-	F
		410	PM	15.8 pc/mi/l <sub>n</sub>	B
W 4th Merge	NB	1150	AM	29.2 pc/mi/l <sub>n</sub>	D
		1050	PM	21.6 pc/mi/l <sub>n</sub>	C
I-71 NB Diverge	NB	1980	AM	42.9 pc/mi/l <sub>n</sub>	E
		710	PM	15.0 pc/mi/l <sub>n</sub>	B
W 5th Diverge	NB	580	AM	16.0 pc/mi/l <sub>n</sub>	B
		280	PM	15.2 pc/mi/l <sub>n</sub>	B
W 2nd Diverge	NB	1200	AM	42.9 pc/mi/l <sub>n</sub>	E
		430	PM	13.5 pc/mi/l <sub>n</sub>	B
W 3rd/W 4th Merge	NB	170	AM	5.6 pc/mi/l <sub>n</sub>	A
		960	PM	30.4 pc/mi/l <sub>n</sub>	D
W 6th Merge	NB	190	AM	5.6 pc/mi/l <sub>n</sub>	A
		530	PM	30.4 pc/mi/l <sub>n</sub>	D
Local/I-71 SB Merge	NB	2130	AM	-	F
		1680	PM	32.1 pc/mi/l <sub>n</sub>	D
Winchell Diverge	NB	180	AM	28.7 pc/mi/l <sub>n</sub>	D
		280	PM	21.0 pc/mi/l <sub>n</sub>	C
W 2nd/W 4th/W 6th Merge	NB	480	AM	26.3 pc/mi/l <sub>n</sub>	D
		2130	PM	20.1 pc/mi/l <sub>n</sub>	C
I-75 NB/WHV Diverge	NB	1510	AM	31.1 pc/mi/l <sub>n</sub>	D
		1440	PM	29.4 pc/mi/l <sub>n</sub>	D
Central Pkwy/WHV Diverge	NB	540	AM	31.1 pc/mi/l <sub>n</sub>	D
		160	PM	29.4 pc/mi/l <sub>n</sub>	D

## Alternative G Traffic Data - Ramp Segments

*Data Corresponds With Level of Service Exhibits*

Alternative G I-71/I-75 Connector Ramp Junctions					
Ramp Junction	Direction	Ramp Volumes	Peak	Density	LOS
Bank/WHV Merge	NB	230	AM	20.0 pc/mi/l <sub>n</sub>	C
		400	PM	26.1 pc/mi/l <sub>n</sub>	D
US 50 WB Diverge	NB	850	AM	17.5 pc/mi/l <sub>n</sub>	B
		810	PM	16.6 pc/mi/l <sub>n</sub>	B
WHV Merge	SB	1560	AM	32.3 pc/mi/l <sub>n</sub>	D
		860	PM	23.9 pc/mi/l <sub>n</sub>	C
Findlay Diverge	SB	620	AM	30.5 pc/mi/l <sub>n</sub>	D
		670	PM	24.5 pc/mi/l <sub>n</sub>	C
Freeman Diverge	SB	810	AM	28.9 pc/mi/l <sub>n</sub>	D
		580	PM	21.1 pc/mi/l <sub>n</sub>	C
I-71 NB/local ramp Diverge	SB	2880	AM	18.2 pc/mi/l <sub>n</sub>	C
		2060	PM	18.4 pc/mi/l <sub>n</sub>	D
W 3rd/W 5th Diverge	SB	670	AM	12.6 pc/mi/l <sub>n</sub>	B
		240	PM	29.9 pc/mi/l <sub>n</sub>	D
US 50/W 9th Merge	SB	670	AM	14.7 pc/mi/l <sub>n</sub>	B
		820	PM	24.9 pc/mi/l <sub>n</sub>	C
US 50 Merge	SB	760	AM	13.6 pc/mi/l <sub>n</sub>	B
		1320	PM	29.9 pc/mi/l <sub>n</sub>	C
W 3rd Merge	SB	470	AM	18.1 pc/mi/l <sub>n</sub>	C
		1770	PM	-	F
W 5th Diverge (KY)	SB	650	AM	13.8 pc/mi/l <sub>n</sub>	B
		690	PM	-	F
W 9th/Pike Diverge	SB	430	AM	8.2 pc/mi/l <sub>n</sub>	A
		940	PM	-	F
US 50 to W 2nd Merge	SB	260	AM	19.6 pc/mi/l <sub>n</sub>	B
		90	PM	13.9 pc/mi/l <sub>n</sub>	B
US 50 to I-71 NB Merge	SB	1690	AM	32.3 pc/mi/l <sub>n</sub>	D
		1140	PM	23.0 pc/mi/l <sub>n</sub>	C
I-71 NB/W 2nd Split	SB	1820	AM	25.3 pc/mi/l <sub>n</sub>	C
		930	PM	23.0 pc/mi/l <sub>n</sub>	C

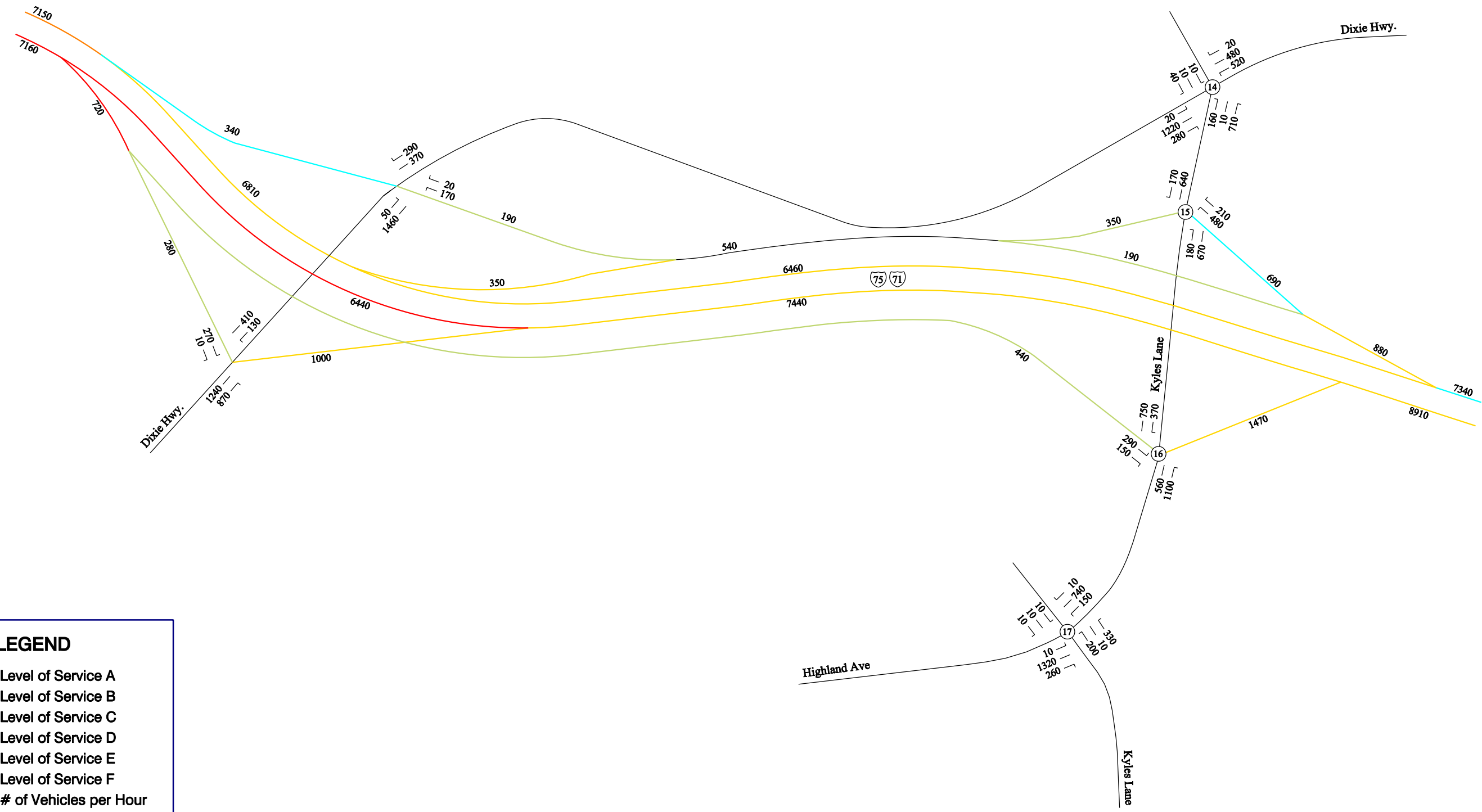

**LEGEND**

- Level of Service A
- Level of Service B
- Level of Service C
- Level of Service D
- Level of Service E
- Level of Service F
- 2569 # of Vehicles per Hour
- (12) Intersection ID #

NOT TO SCALE



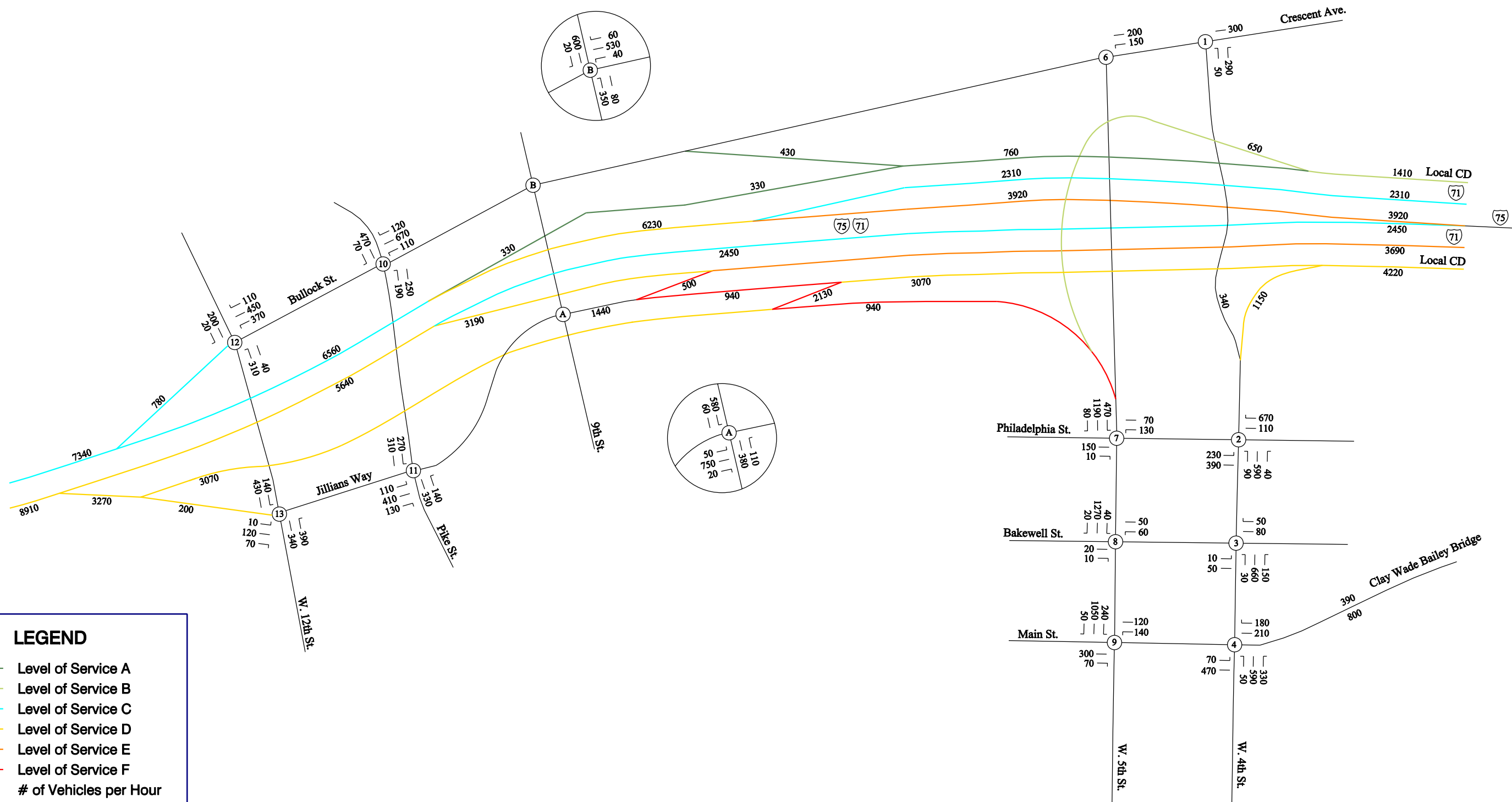

**LEGEND**

- Level of Service A
- Level of Service B
- Level of Service C
- Level of Service D
- Level of Service E
- Level of Service F
- 2569 # of Vehicles per Hour
- ⑫ Intersection ID #

NOT TO SCALE



**2035 AM LEVEL OF SERVICE  
ALTERNATIVE G  
(KENTUCKY)**

SHEET  
(2 OF 9)

**EXHIBIT  
A11-B**

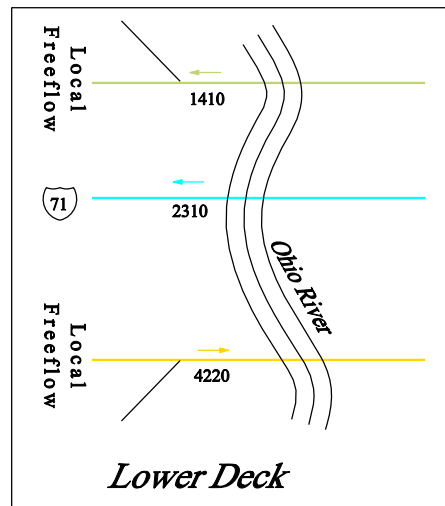
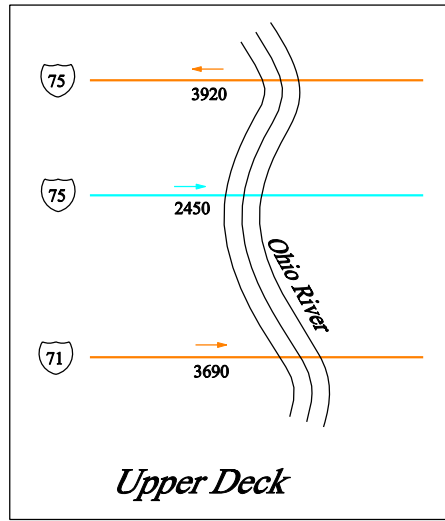

**LEGEND**

- Level of Service A
  - Level of Service B
  - Level of Service C
  - Level of Service D
  - Level of Service E
  - Level of Service F
- 2569 # of Vehicles per Hour  
 (12) Intersection ID #

NOT TO SCALE

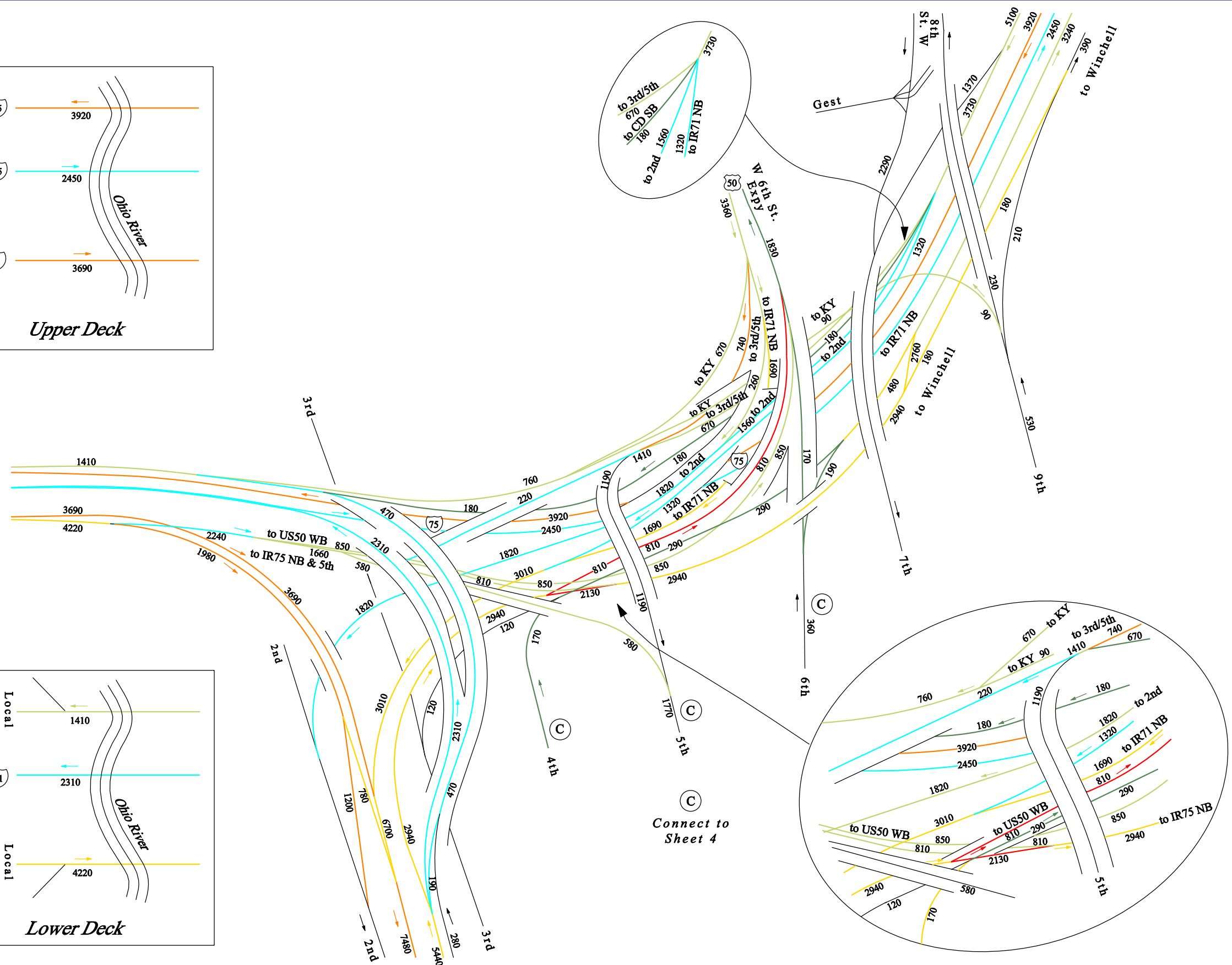

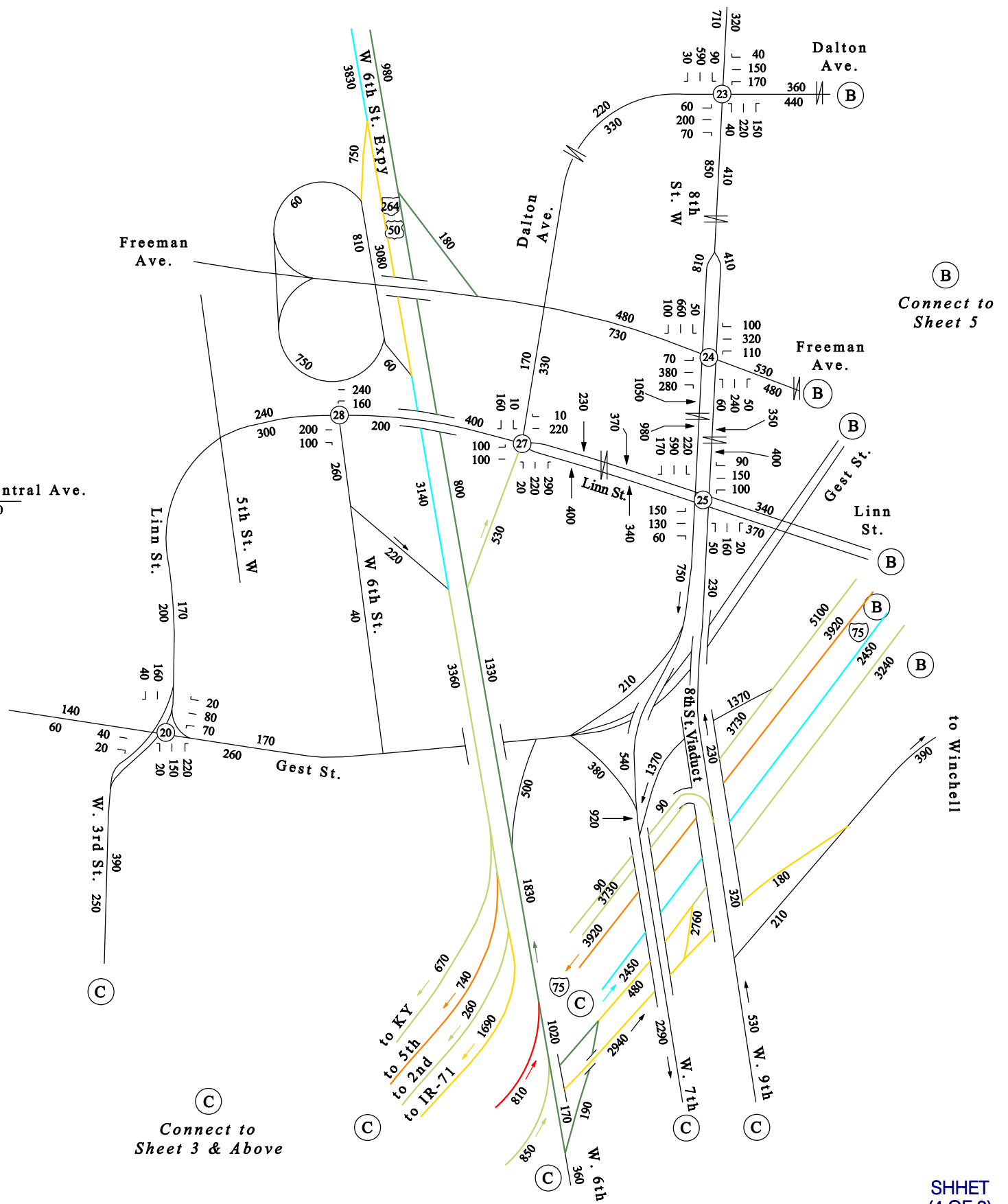
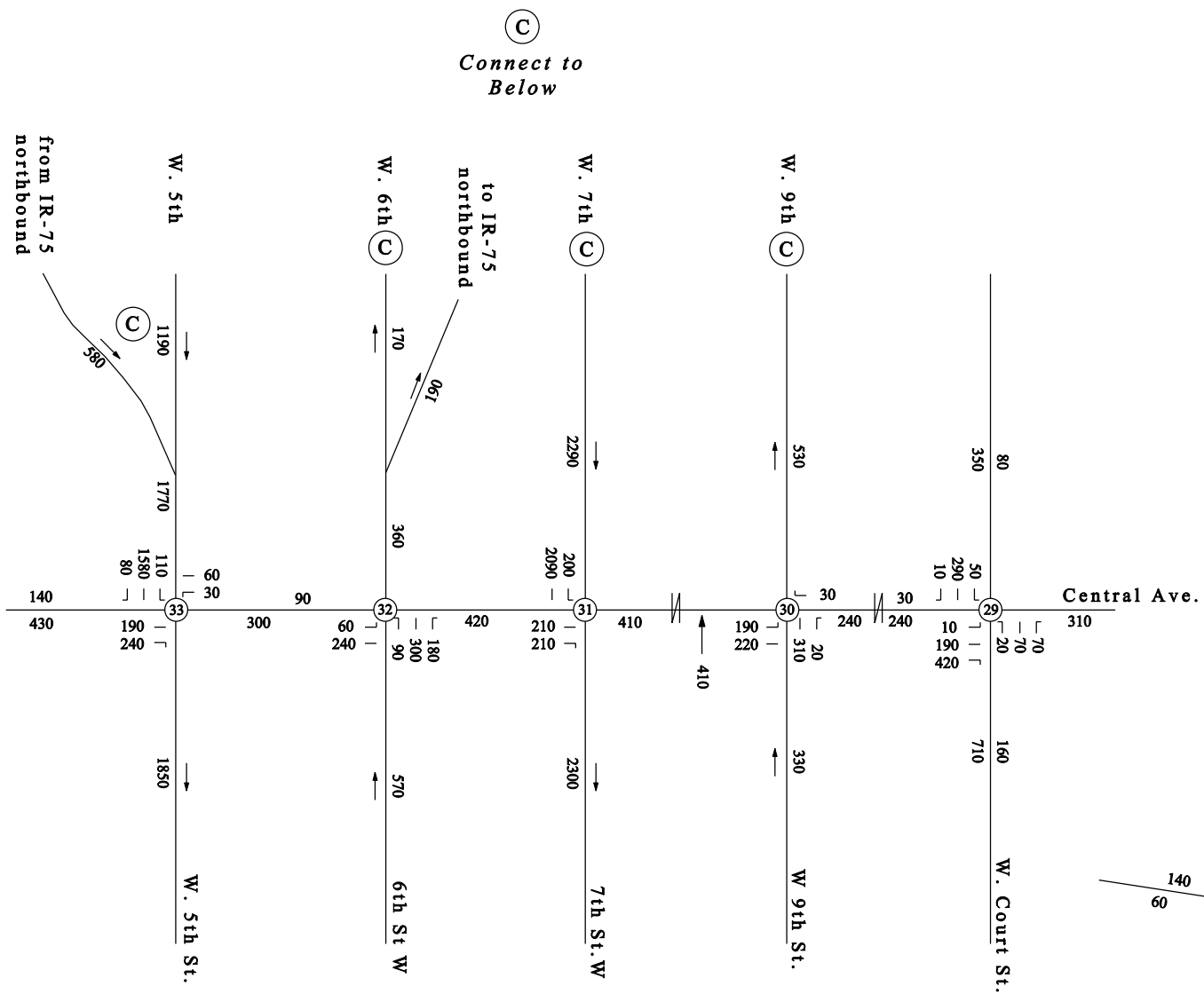

**LEGEND**

- Level of Service A
- Level of Service B
- Level of Service C
- Level of Service D
- Level of Service E
- Level of Service F
- 2569 # of Vehicles per Hour
- (12) Intersection ID #

NOT TO SCALE



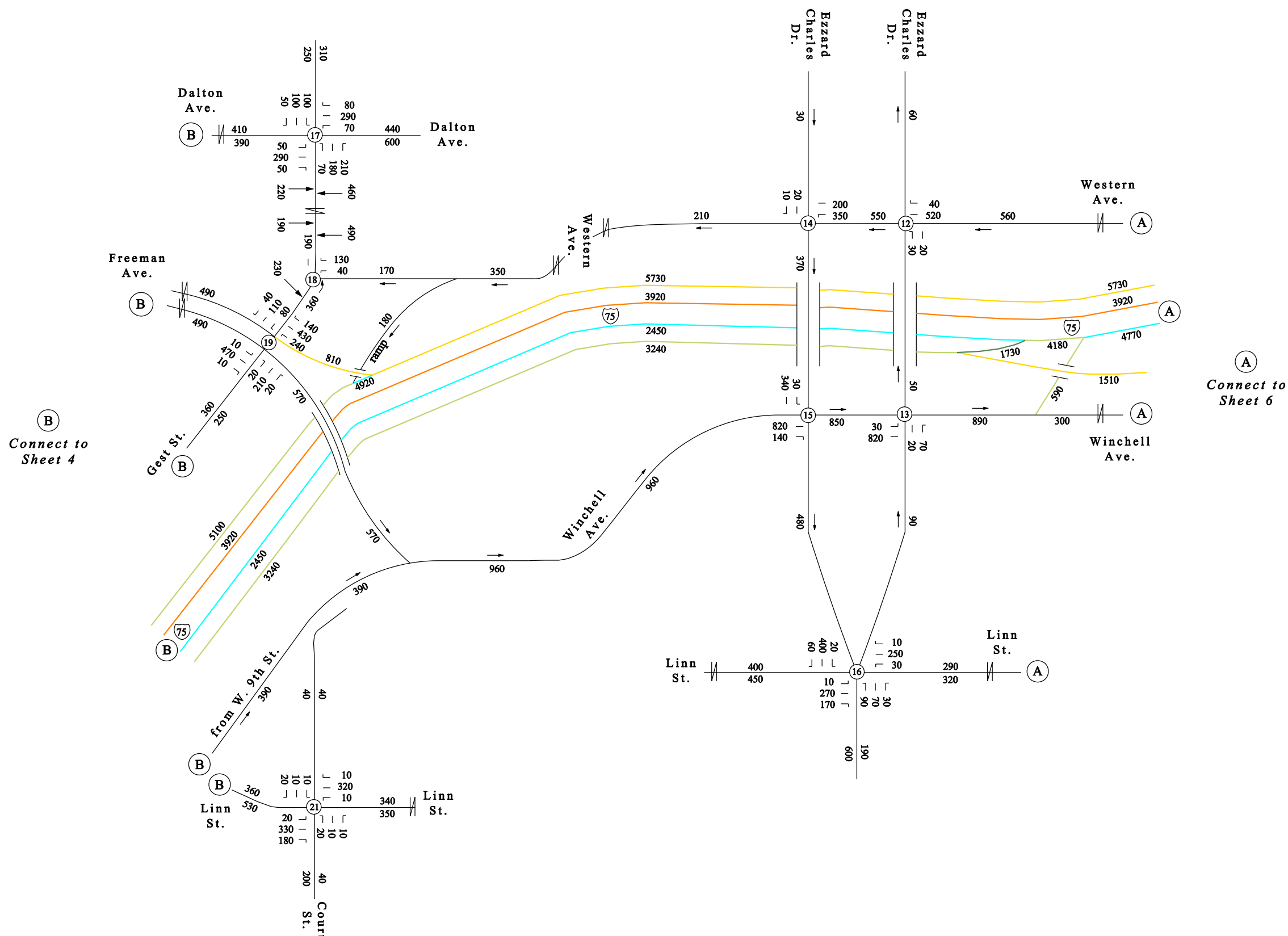

**LEGEND**

- Level of Service A
- Level of Service B
- Level of Service C
- Level of Service D
- Level of Service E
- Level of Service F
- 2569 # of Vehicles per Hour
- (12) Intersection ID #

NOT TO SCALE



**2035 AM LEVEL OF SERVICE  
ALTERNATIVE G  
(OHIO)**

SHEET  
(5 OF 9)

**EXHIBIT  
A11-E**

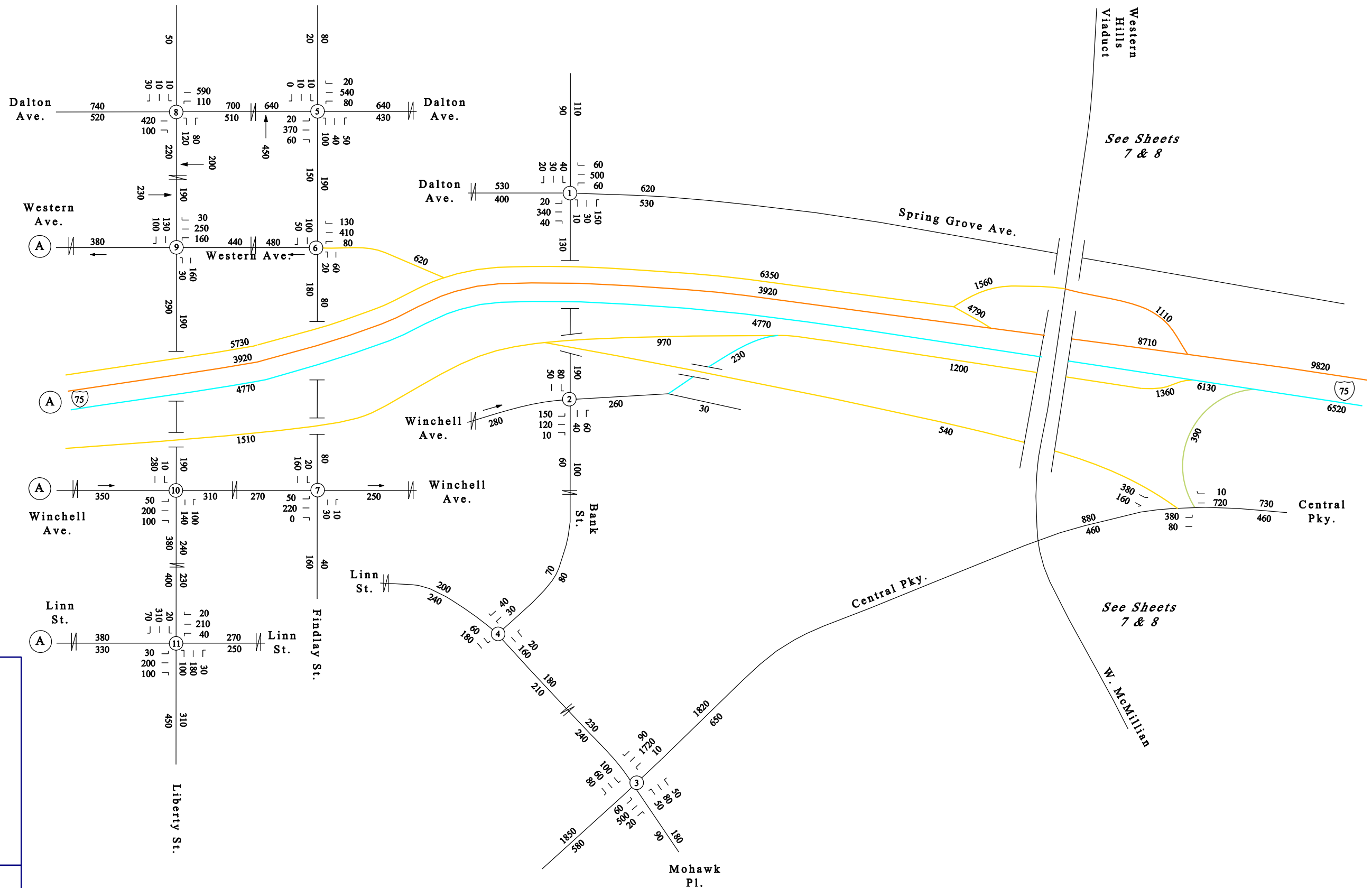

Ⓐ  
Connect to  
Sheet 5

See Sheets  
7 & 8

See Sheets  
7 & 8

**LEGEND**

- Level of Service A
- Level of Service B
- Level of Service C
- Level of Service D
- Level of Service E
- Level of Service F
- 2569 # of Vehicles per Hour
- Ⓐ Intersection ID #

NOT TO SCALE

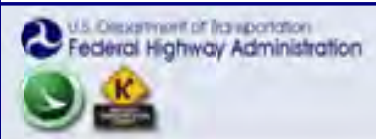

**2035 AM LEVEL OF SERVICE  
ALTERNATIVE G  
(OHIO)**

SHEET  
(6 OF 9)

**EXHIBIT  
A11-F**



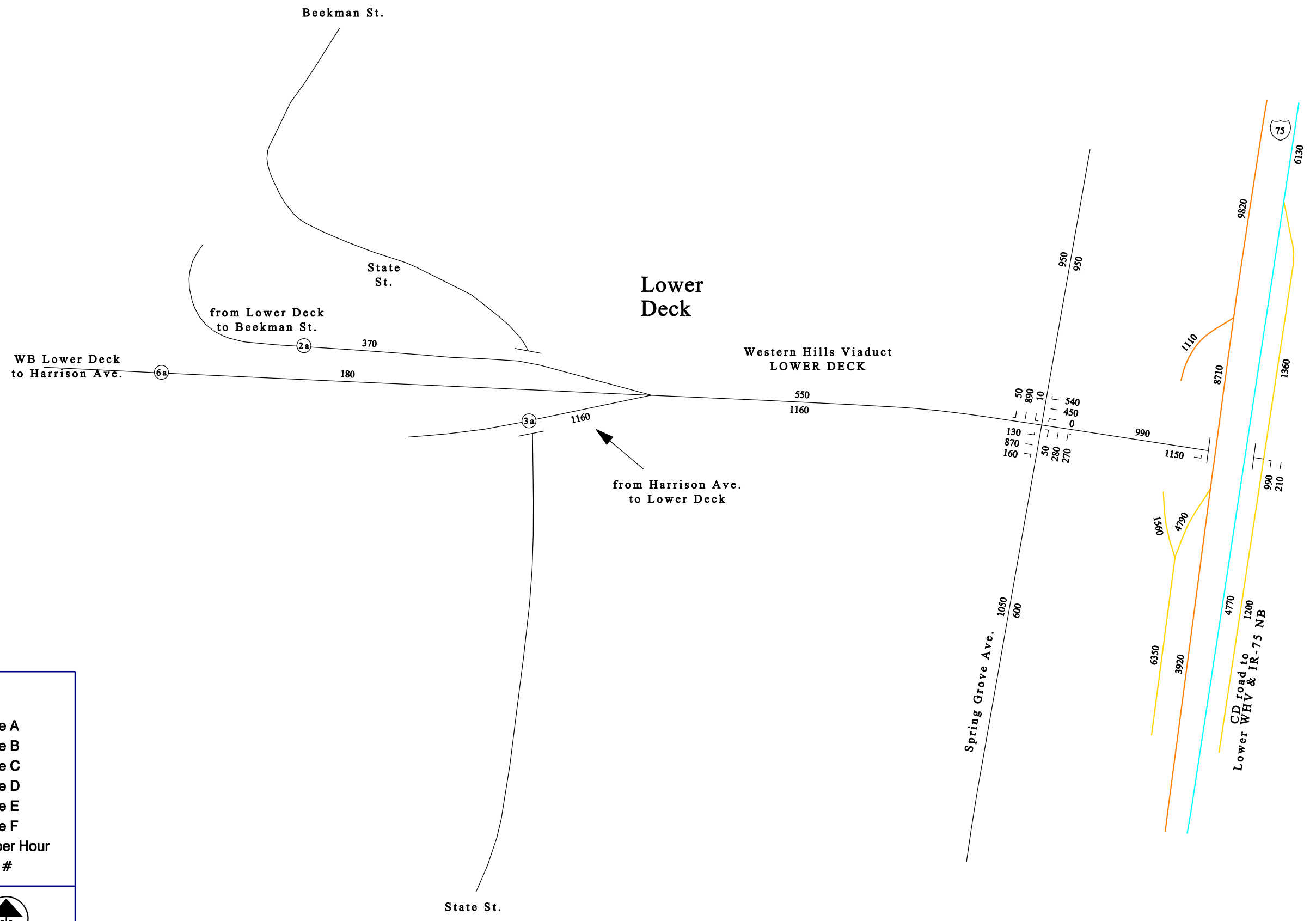

**LEGEND**

- Level of Service A
- Level of Service B
- Level of Service C
- Level of Service D
- Level of Service E
- Level of Service F
- 2569 # of Vehicles per Hour
- (12) Intersection ID #

NOT TO SCALE



**2035 AM LEVEL OF SERVICE  
ALTERNATIVE G  
(OHIO)**

SHEET  
(7 OF 9)

**EXHIBIT  
A11-G**

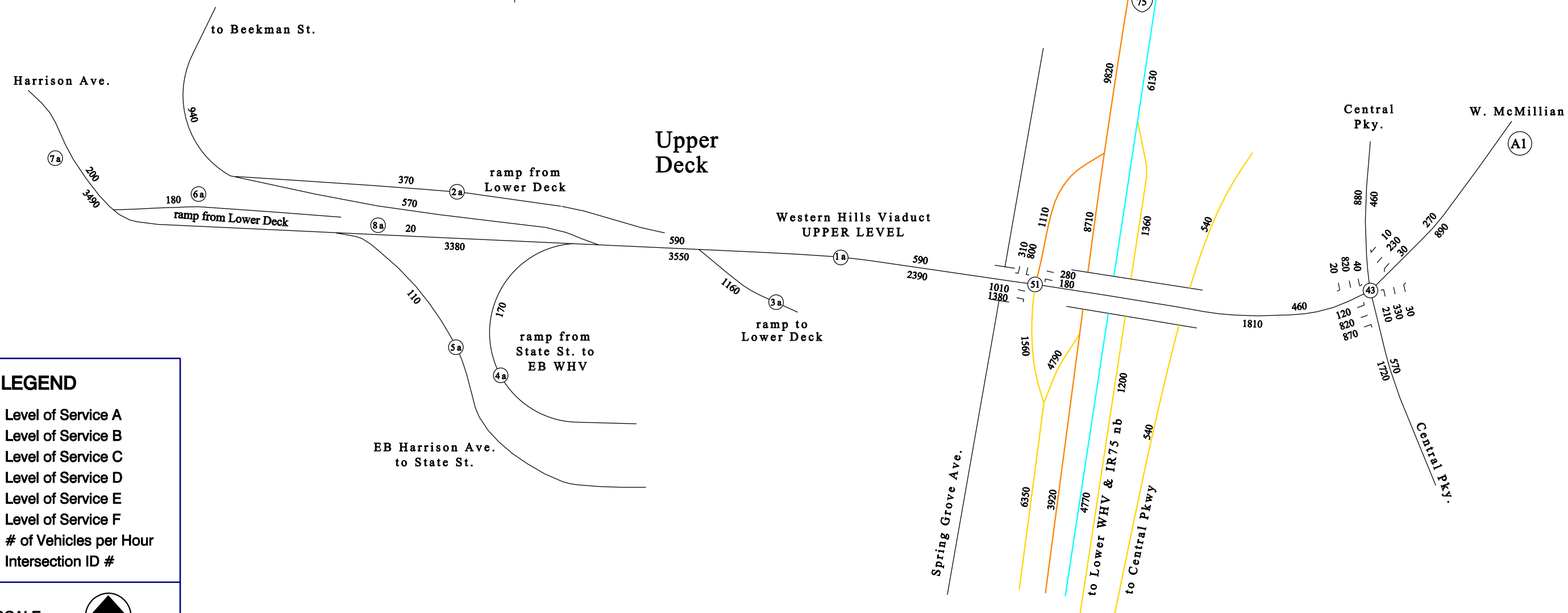
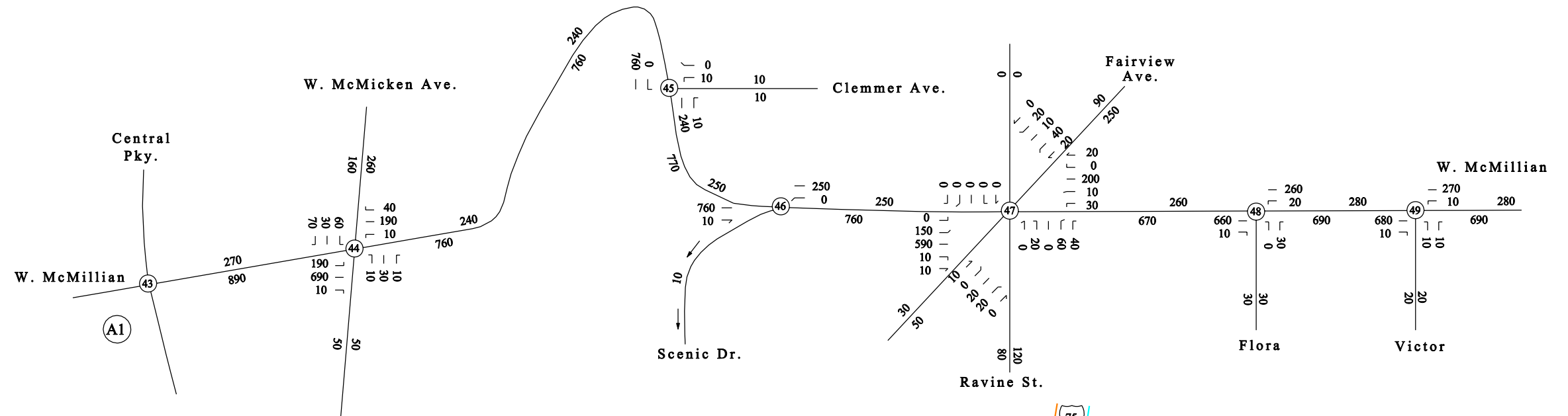

**LEGEND**

- Level of Service A
- Level of Service B
- Level of Service C
- Level of Service D
- Level of Service E
- Level of Service F
- 2569 # of Vehicles per Hour
- (12) Intersection ID #

NOT TO SCALE



**2035 AM LEVEL OF SERVICE  
ALTERNATIVE G  
(OHIO)**

SHEET  
(8 OF 9)

**EXHIBIT  
A11-H**

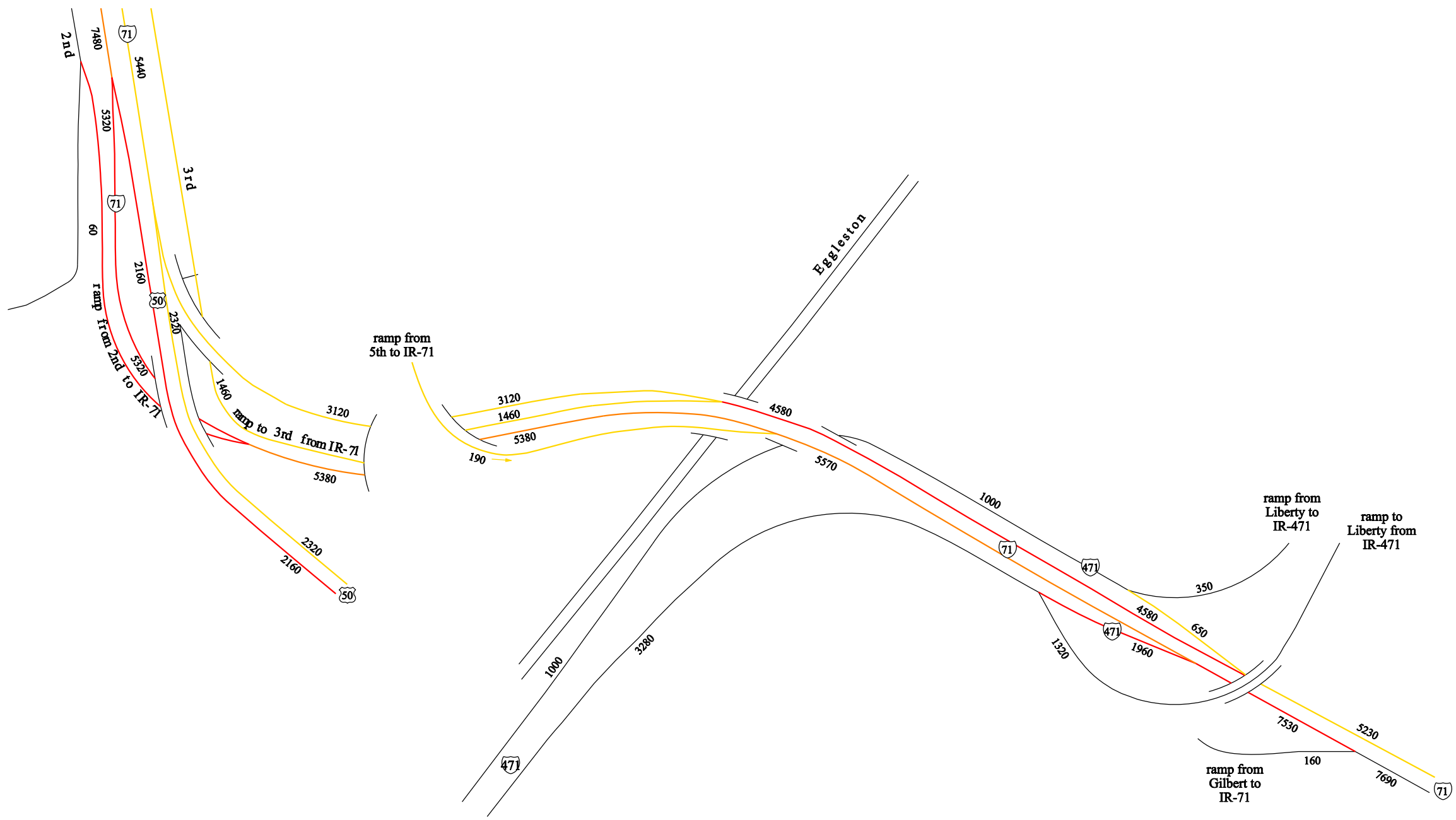

**LEGEND**

- Level of Service A
- Level of Service B
- Level of Service C
- Level of Service D
- Level of Service E
- Level of Service F
- 2569 # of Vehicles per Hour
- (12) Intersection ID #

NOT TO SCALE



**2035 AM LEVEL OF SERVICE  
ALTERNATIVE G  
(OHIO)**

SHEET  
(9 OF 9)

**EXHIBIT  
A11-I**

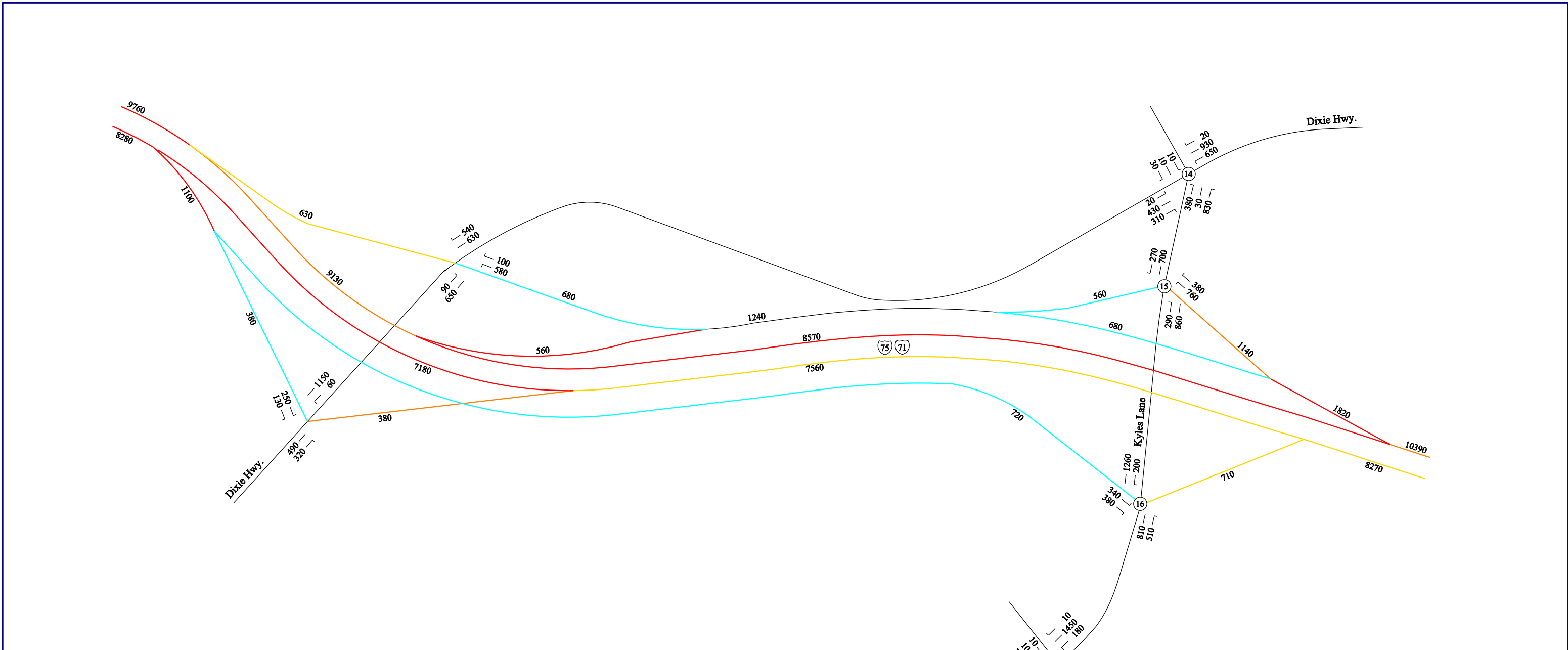

**LEGEND**

- Level of Service A
- Level of Service B
- Level of Service C
- Level of Service D
- Level of Service E
- Level of Service F
- 2569 # of Vehicles per Hour
- (12) Intersection ID #

NOT TO SCALE



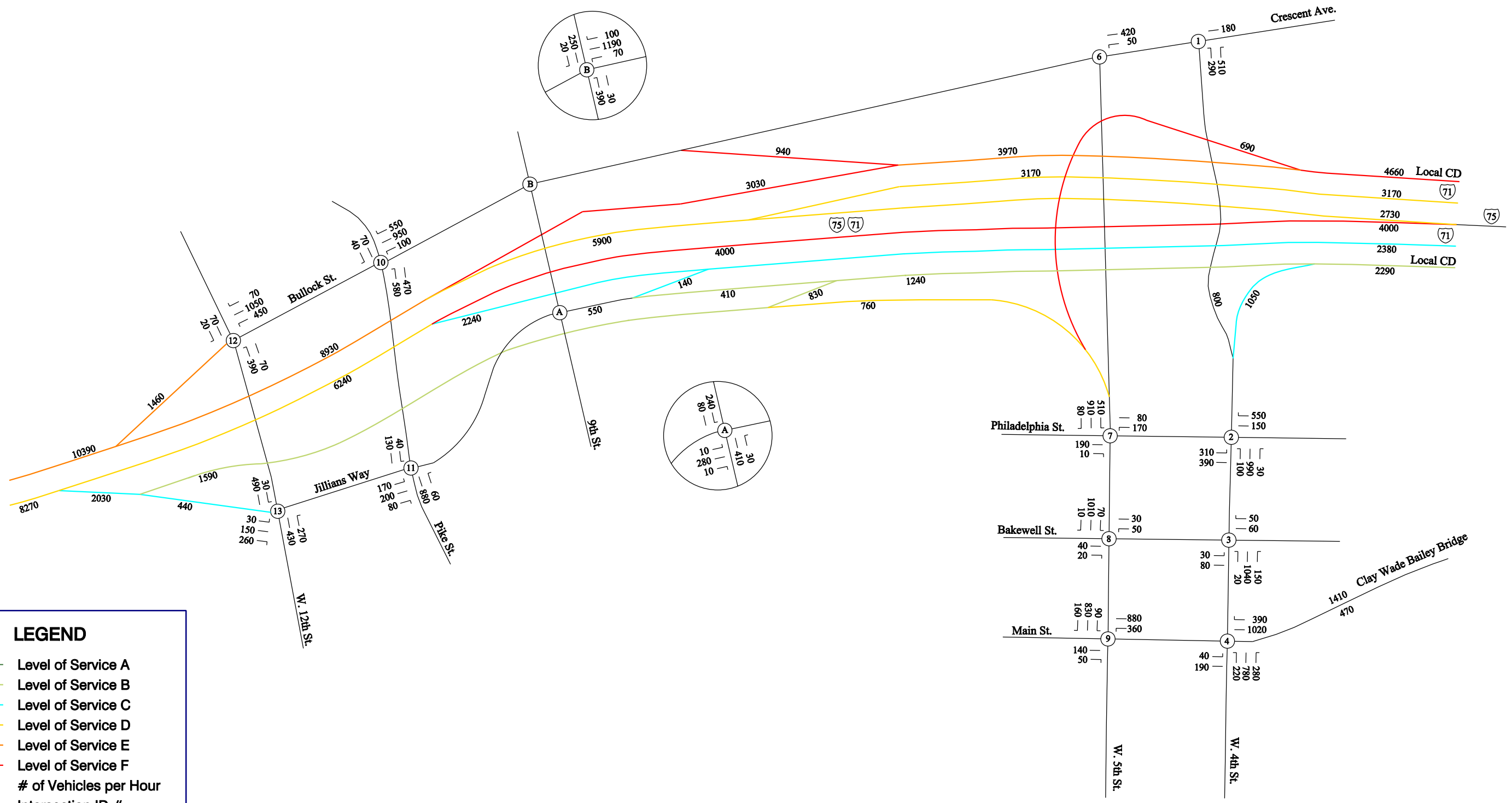

**LEGEND**

- Level of Service A
- Level of Service B
- Level of Service C
- Level of Service D
- Level of Service E
- Level of Service F
- 2569 # of Vehicles per Hour
- ⑫ Intersection ID #

NOT TO SCALE

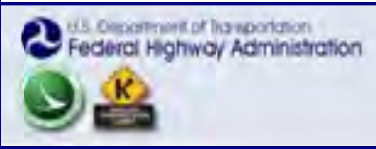

**2035 PM LEVEL OF SERVICE  
ALTERNATIVE G  
(KENTUCKY)**

SHEET  
(2 OF 9)

**EXHIBIT  
A12-B**

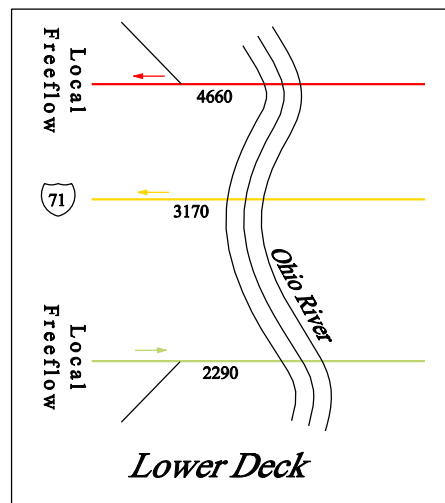
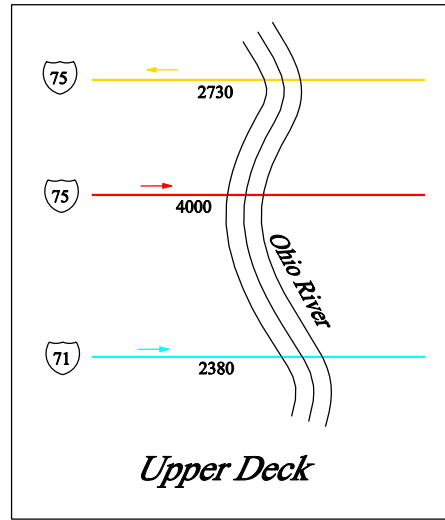

- LEGEND**
- Level of Service A
  - Level of Service B
  - Level of Service C
  - Level of Service D
  - Level of Service E
  - Level of Service F
- 2569 # of Vehicles per Hour  
 (12) Intersection ID #

NOT TO SCALE

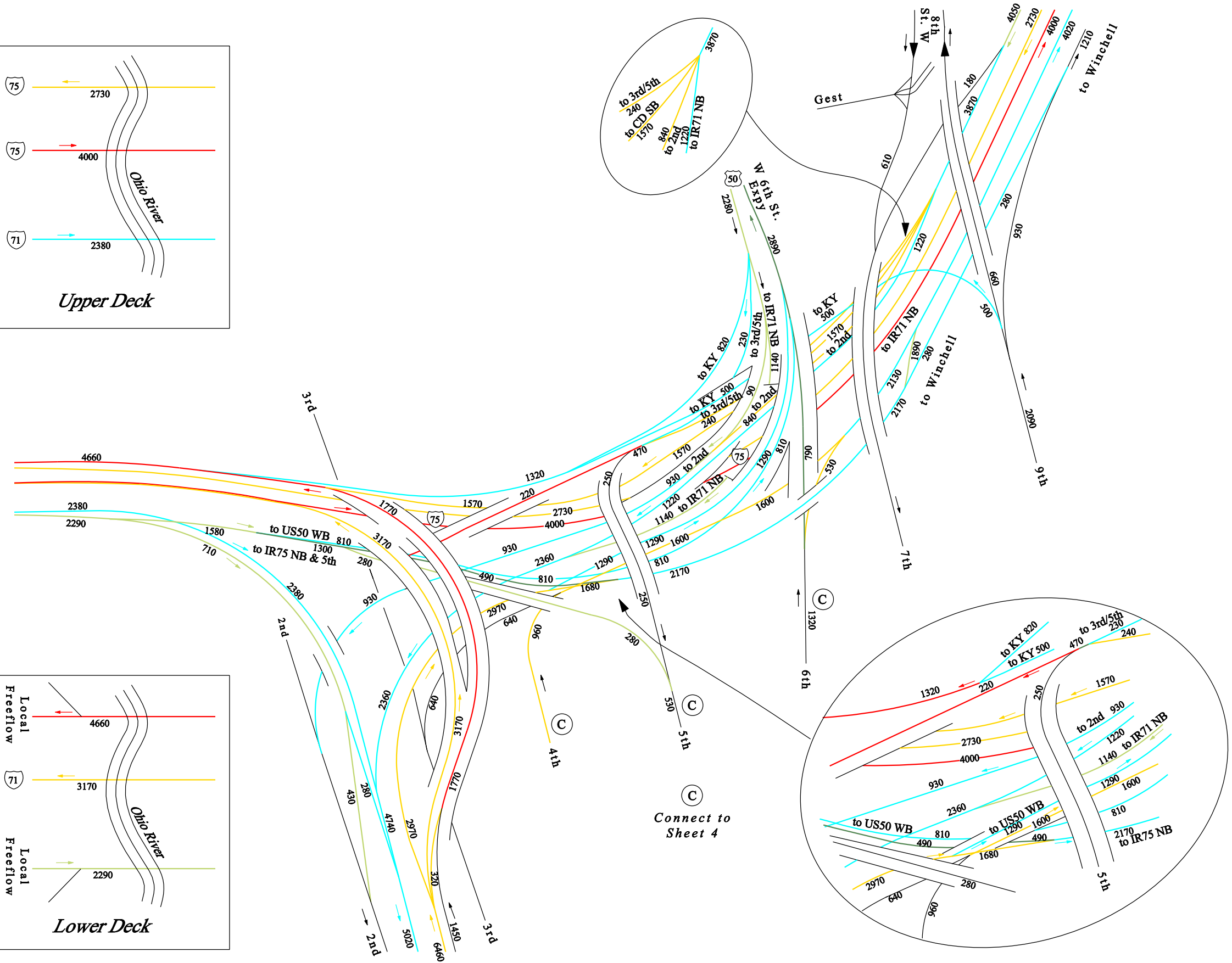

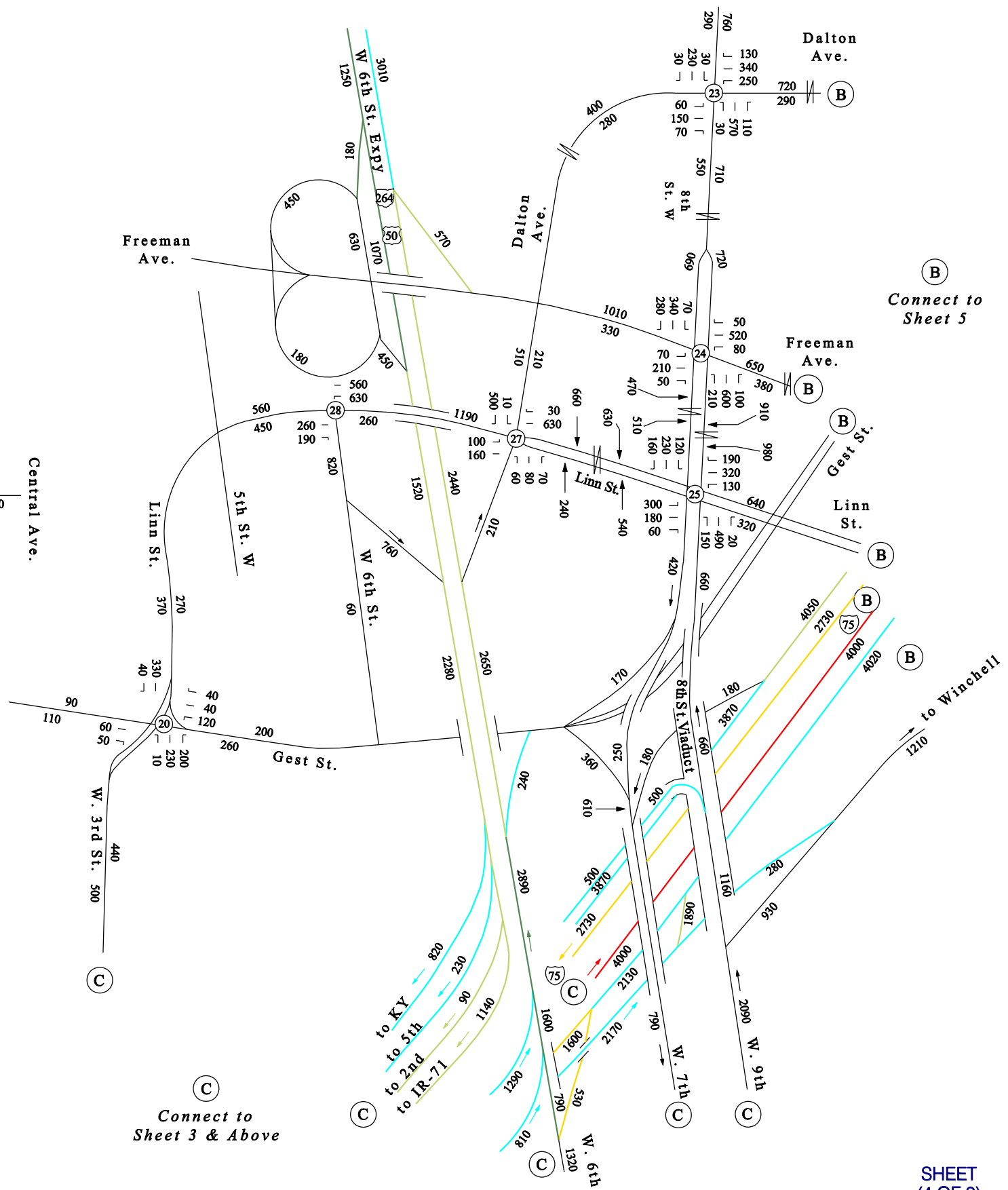
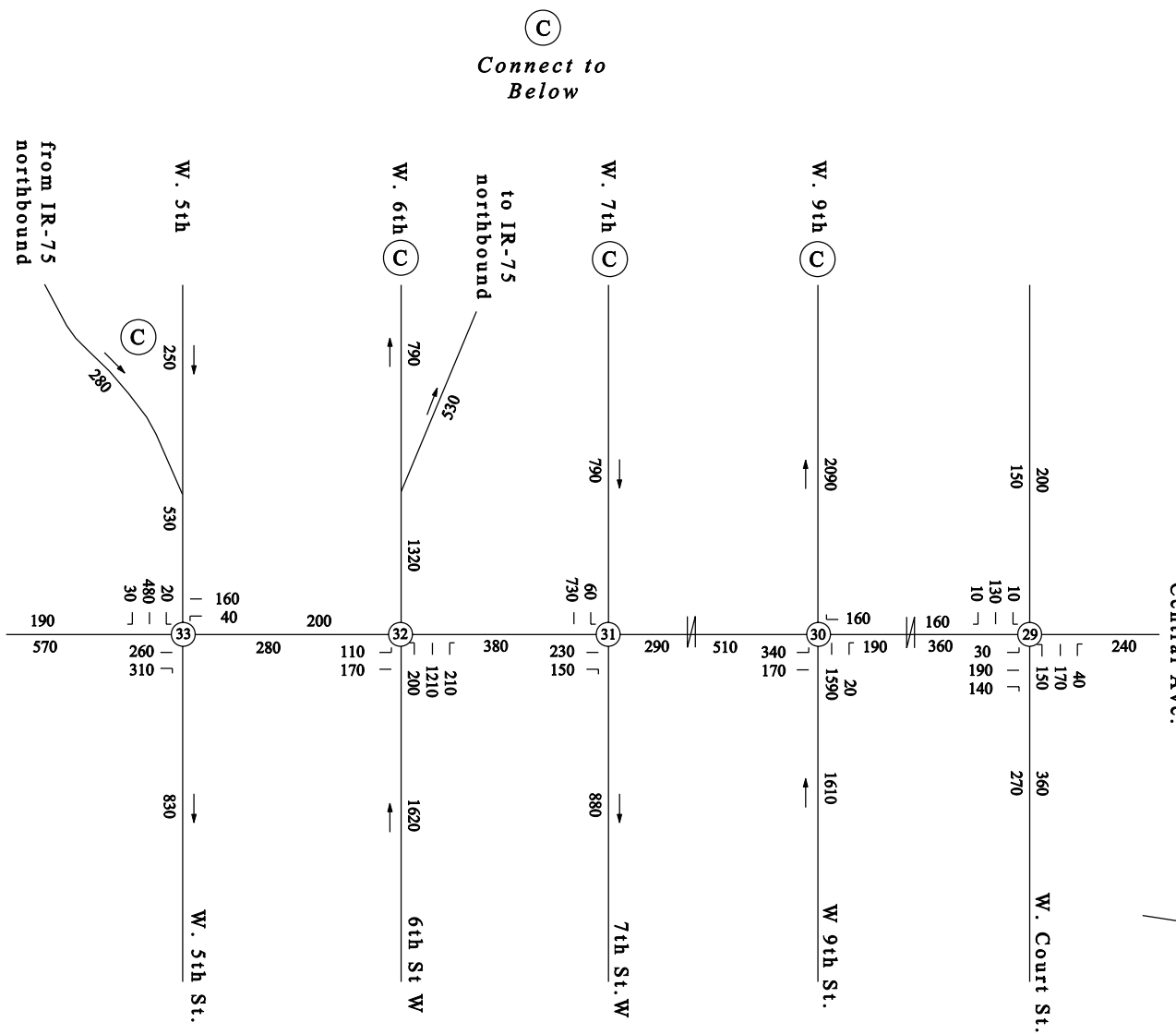

**LEGEND**

- Level of Service A
- Level of Service B
- Level of Service C
- Level of Service D
- Level of Service E
- Level of Service F
- 2569 # of Vehicles per Hour
- (12) Intersection ID #

NOT TO SCALE

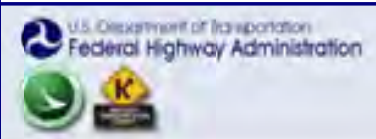

**2035 PM LEVEL OF SERVICE  
ALTERNATIVE G  
(OHIO)**

SHEET  
(4 OF 9)

**EXHIBIT  
A12-D**

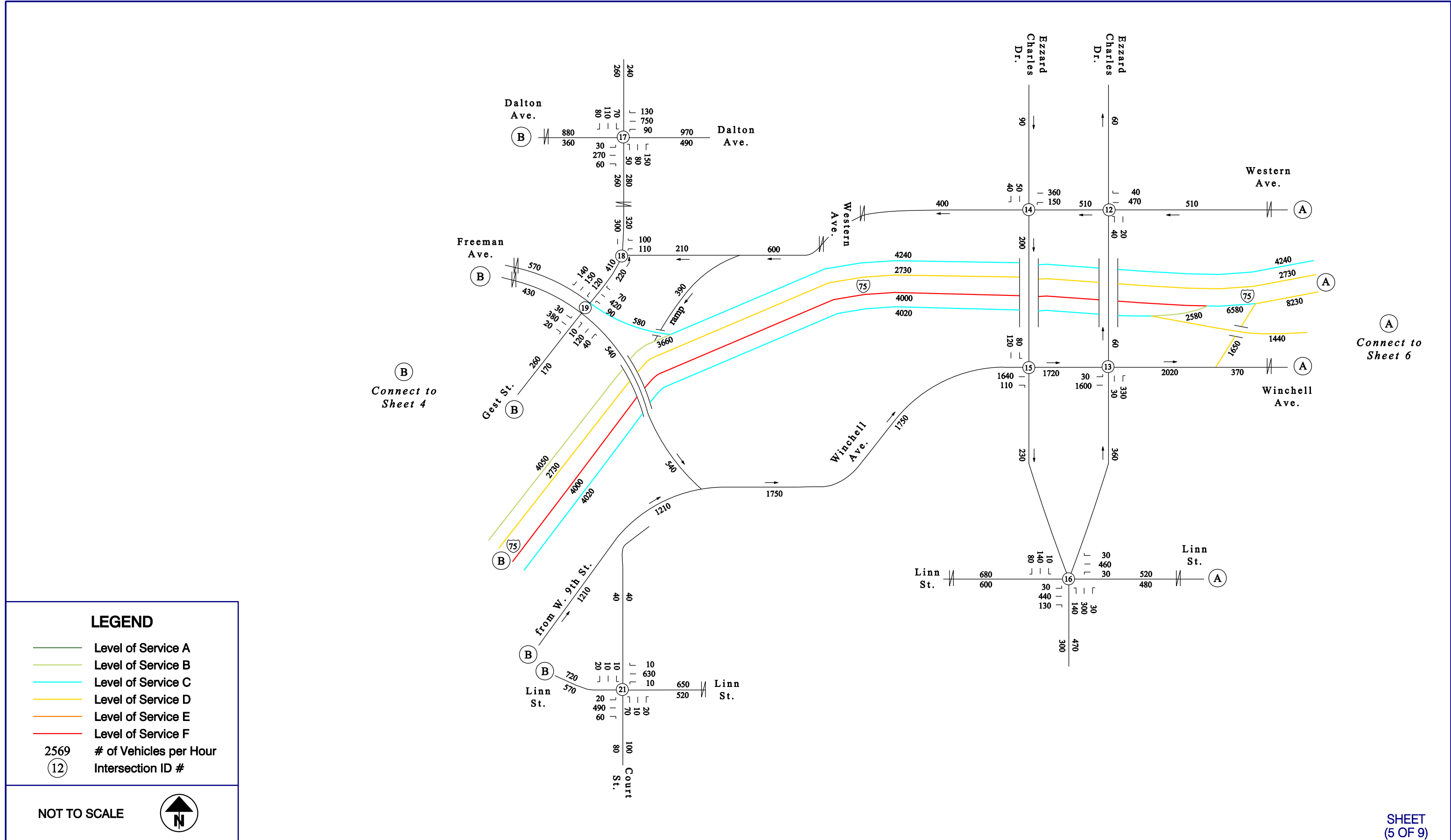



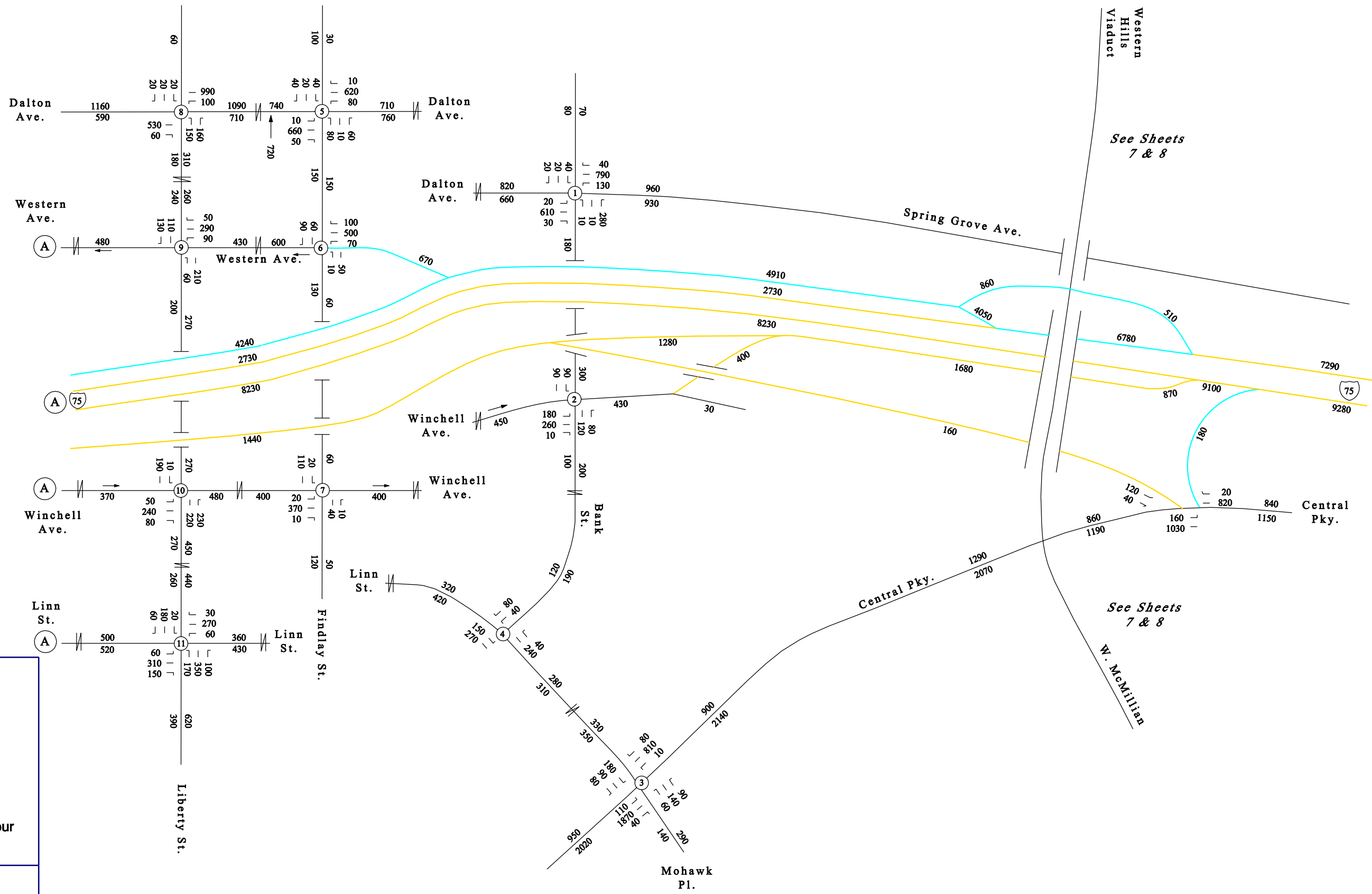

(A)  
Connect to  
Sheet 5

See Sheets  
7 & 8

See Sheets  
7 & 8

**LEGEND**

- Level of Service A
- Level of Service B
- Level of Service C
- Level of Service D
- Level of Service E
- Level of Service F
- 2569 # of Vehicles per Hour
- (12) Intersection ID #

NOT TO SCALE

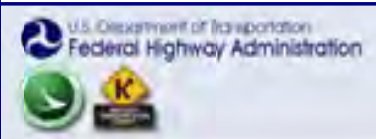

**2035 PM LEVEL OF SERVICE  
ALTERNATIVE G  
(OHIO)**

SHEET  
(6 OF 9)

**EXHIBIT  
A12-F**

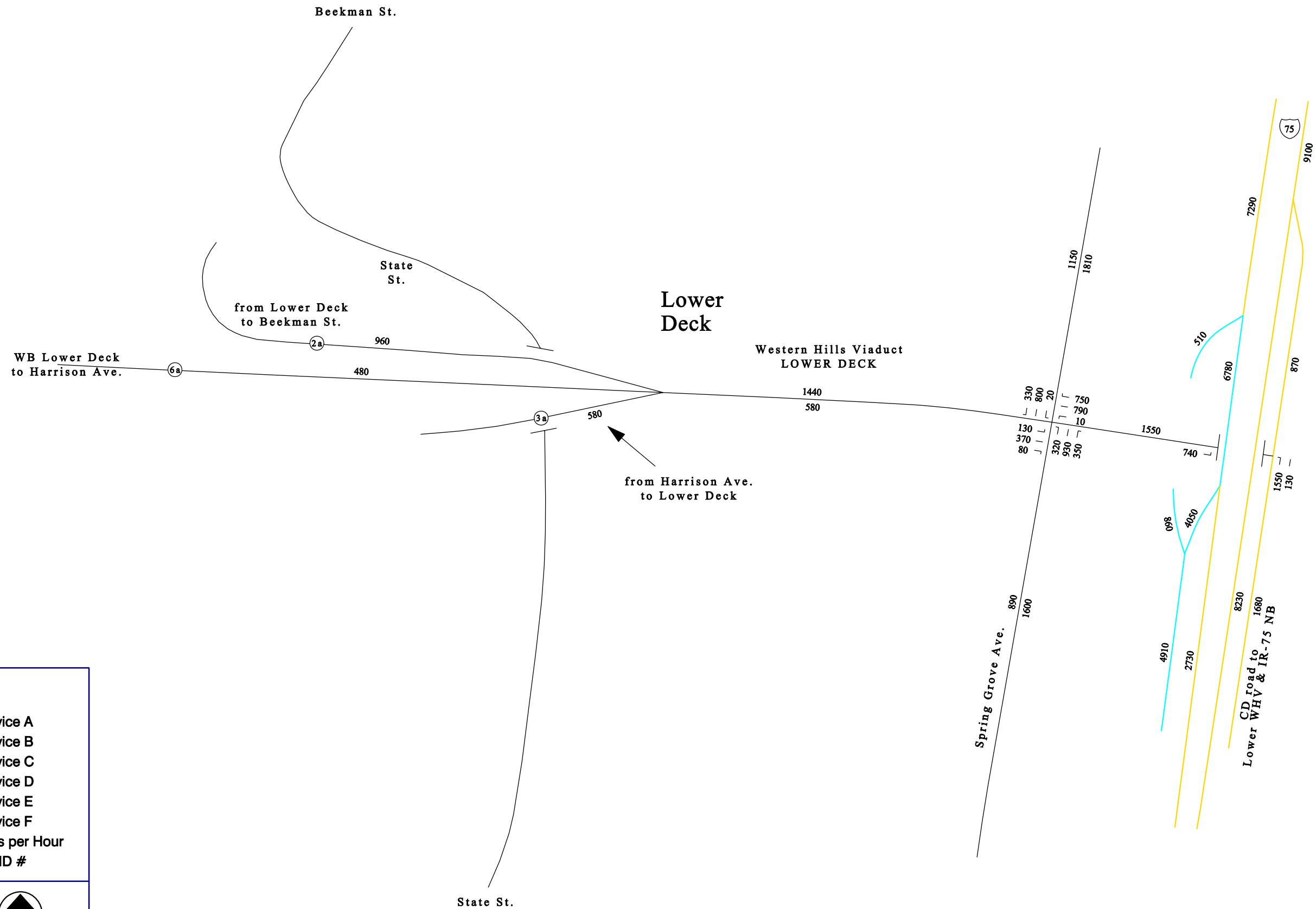

**LEGEND**

- Level of Service A
- Level of Service B
- Level of Service C
- Level of Service D
- Level of Service E
- Level of Service F
- 2569 # of Vehicles per Hour
- (12) Intersection ID #

NOT TO SCALE



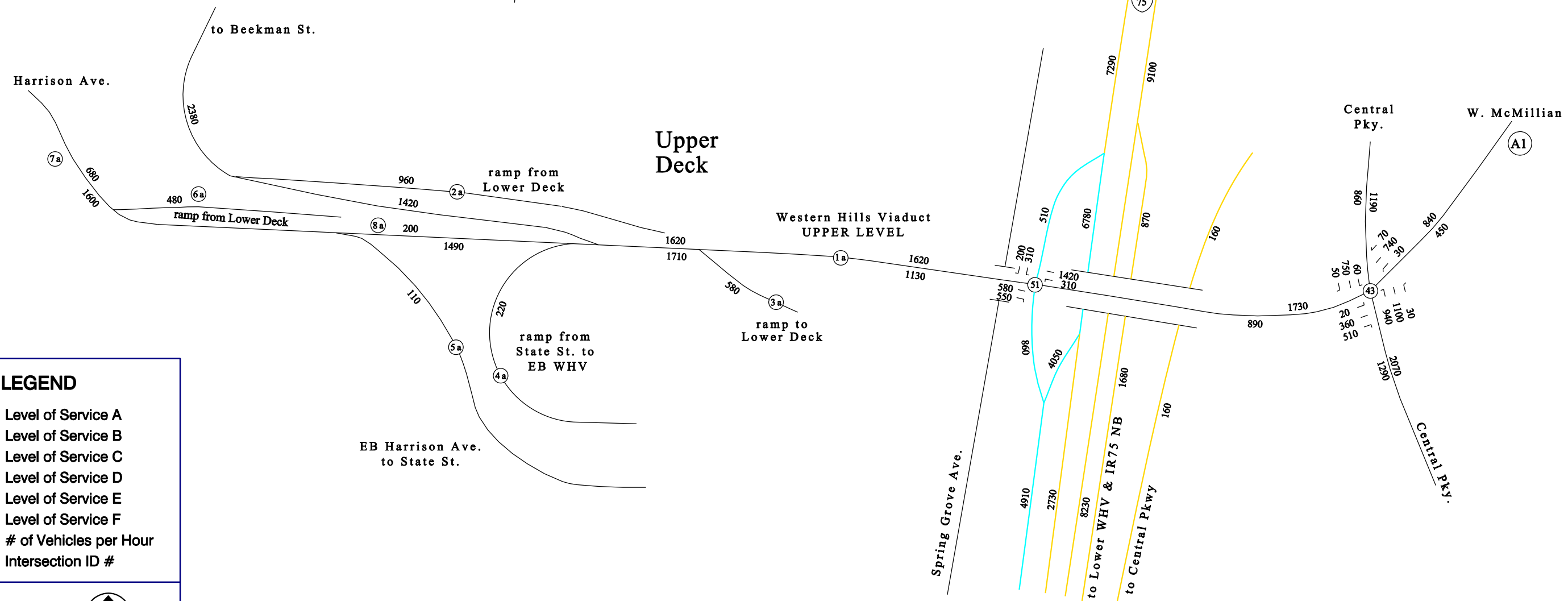
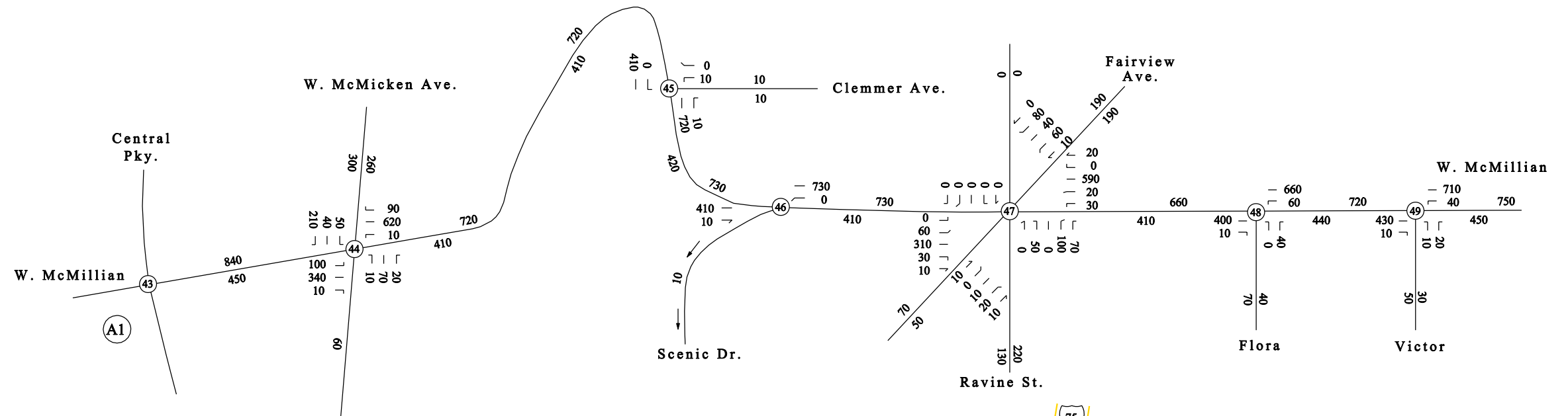

**LEGEND**

- Level of Service A
- Level of Service B
- Level of Service C
- Level of Service D
- Level of Service E
- Level of Service F
- 2569 # of Vehicles per Hour
- (12) Intersection ID #

NOT TO SCALE



**2035 PM LEVEL OF SERVICE  
ALTERNATIVE G  
(OHIO)**

SHEET  
(8 OF 9)

**EXHIBIT  
A12-H**

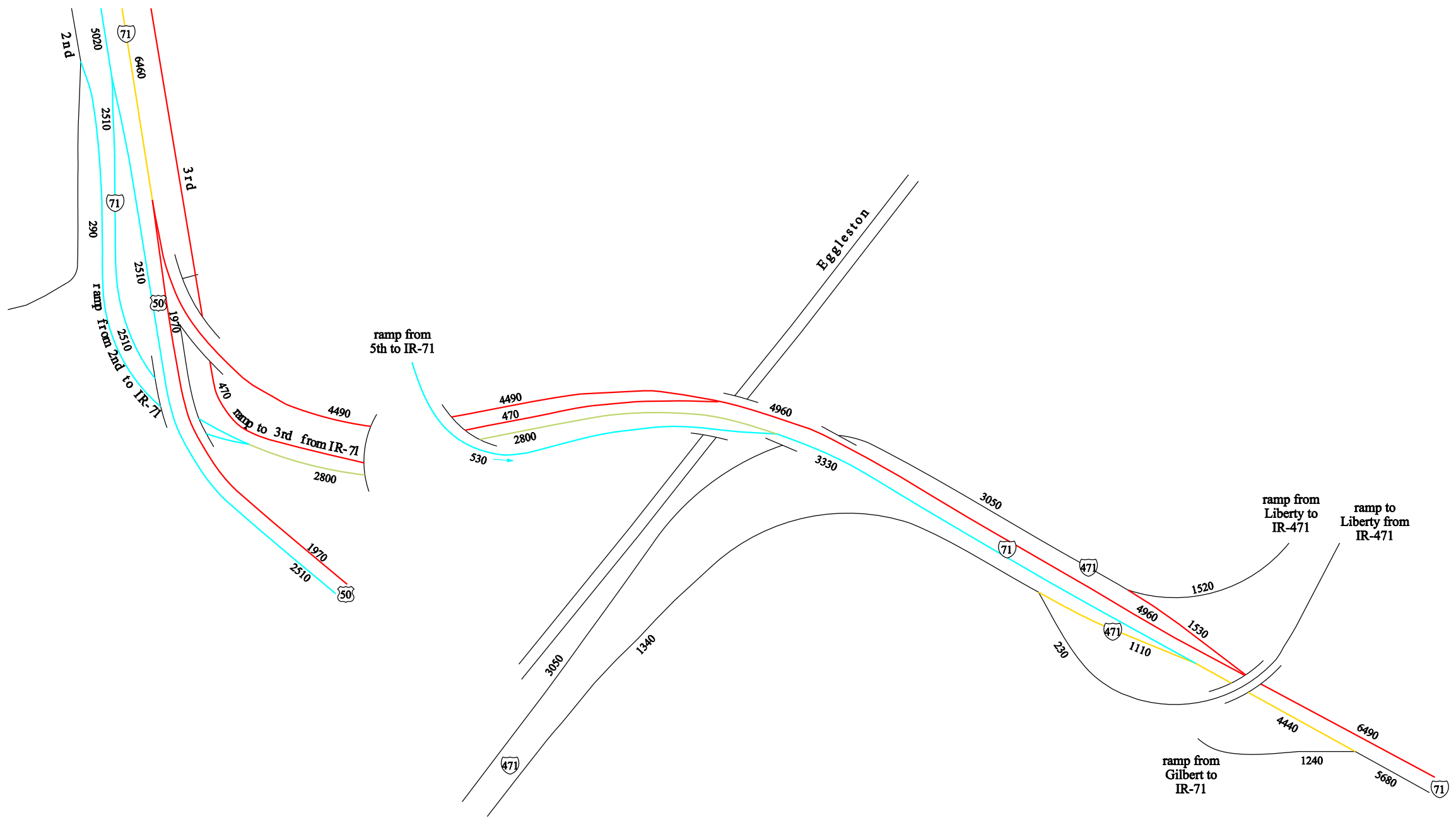

**LEGEND**

- Level of Service A
- Level of Service B
- Level of Service C
- Level of Service D
- Level of Service E
- Level of Service F
- 2569 # of Vehicles per Hour
- (12) Intersection ID #

NOT TO SCALE



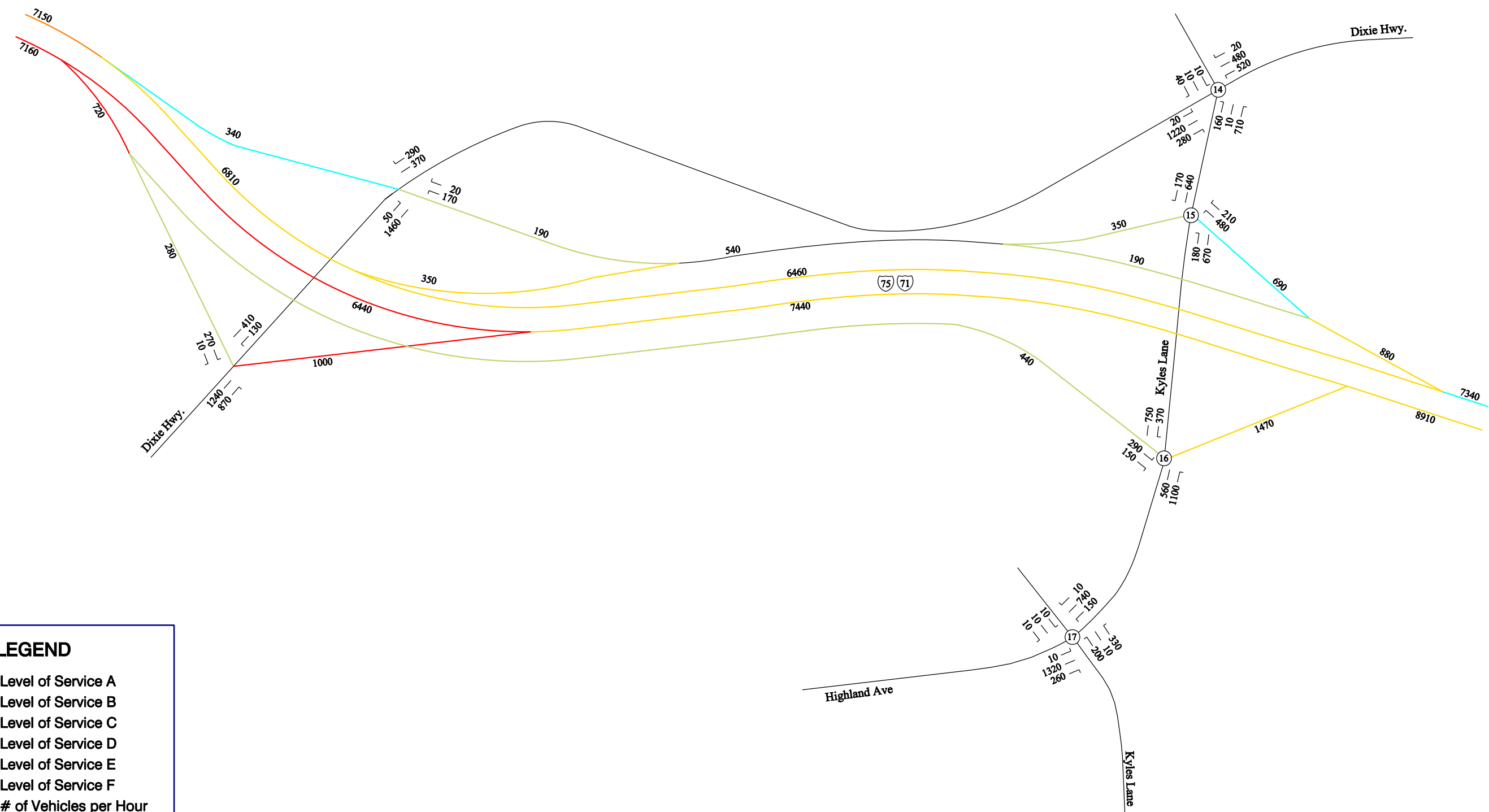

**LEGEND**

- Level of Service A
- Level of Service B
- Level of Service C
- Level of Service D
- Level of Service E
- Level of Service F
- 2569 # of Vehicles per Hour
- (12) Intersection ID #

NOT TO SCALE



**2035 AM LEVEL OF SERVICE  
ALTERNATIVE B  
(KENTUCKY)**

SHEET  
(1 OF 9)

**EXHIBIT  
A3-A**

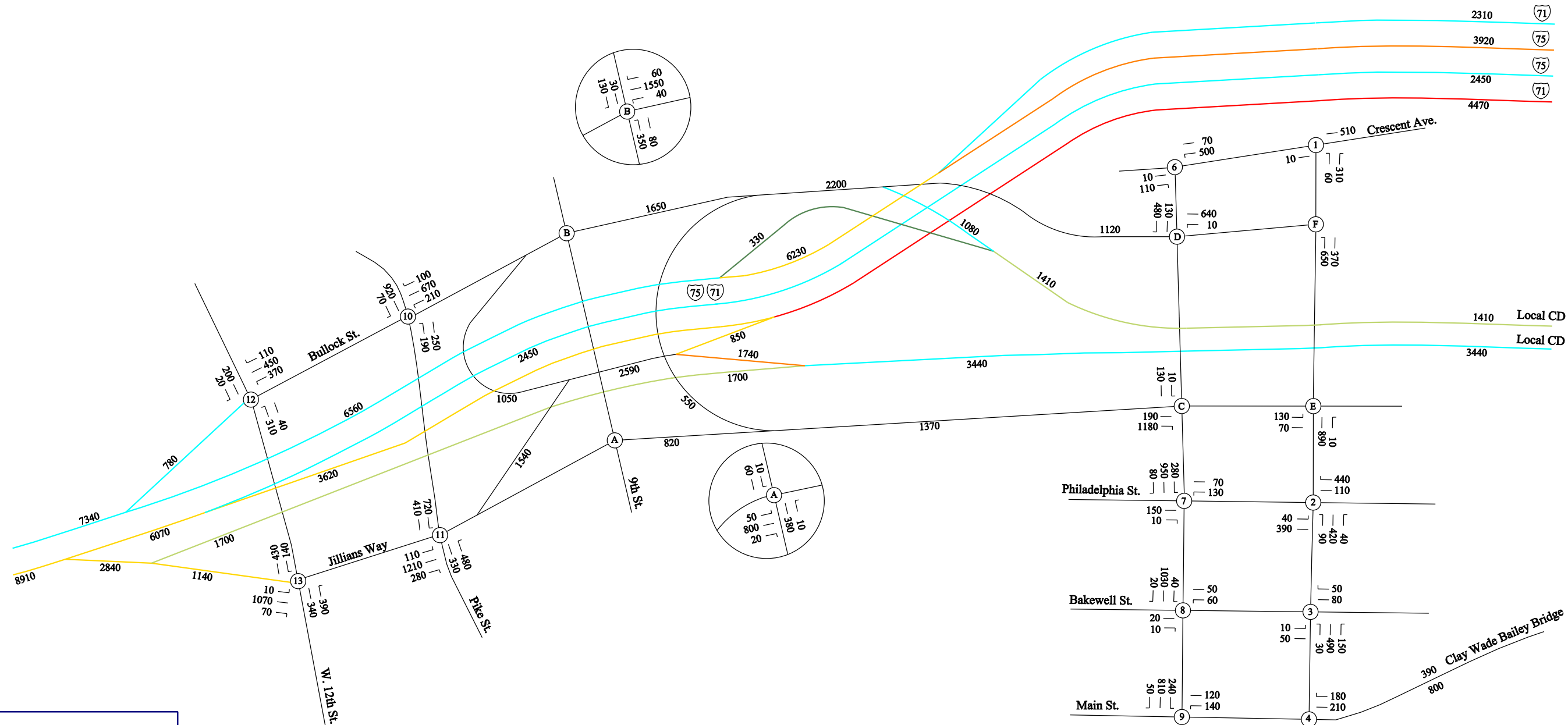

**LEGEND**

- Level of Service A
- Level of Service B
- Level of Service C
- Level of Service D
- Level of Service E
- Level of Service F
- 2569 # of Vehicles per Hour
- (12) Intersection ID #

NOT TO SCALE



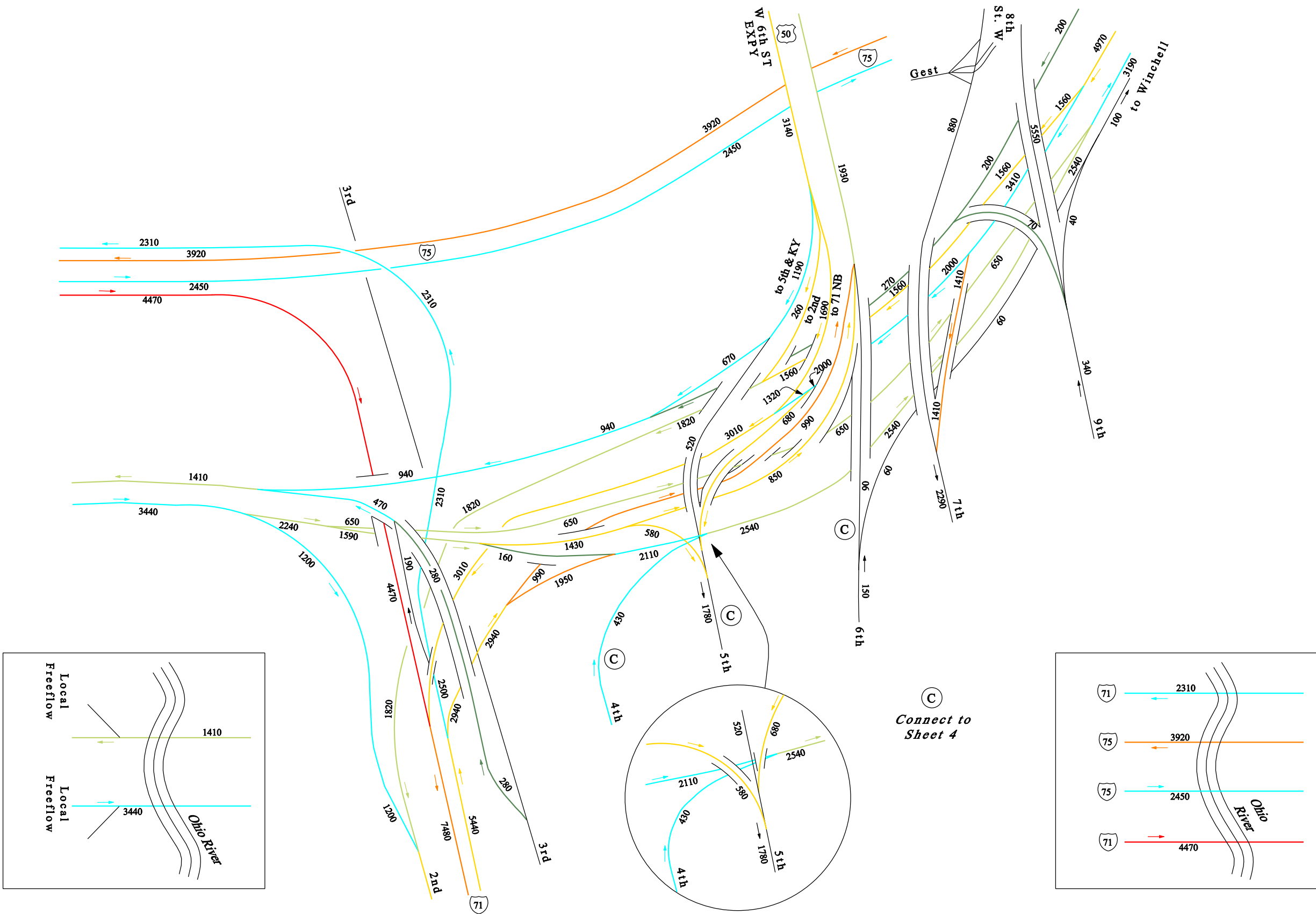

**LEGEND**

- Level of Service A
  - Level of Service B
  - Level of Service C
  - Level of Service D
  - Level of Service E
  - Level of Service F
- 2569 # of Vehicles per Hour  
 (12) Intersection ID #

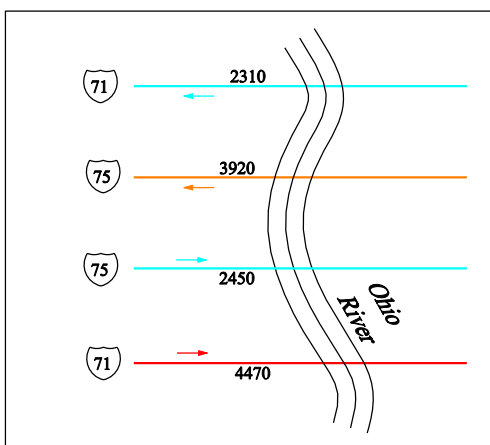
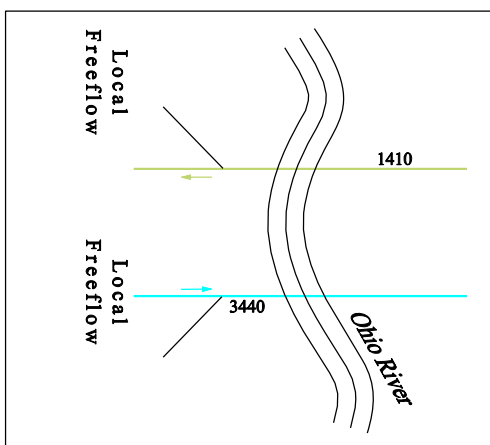

NOT TO SCALE

Connect to Sheet 4



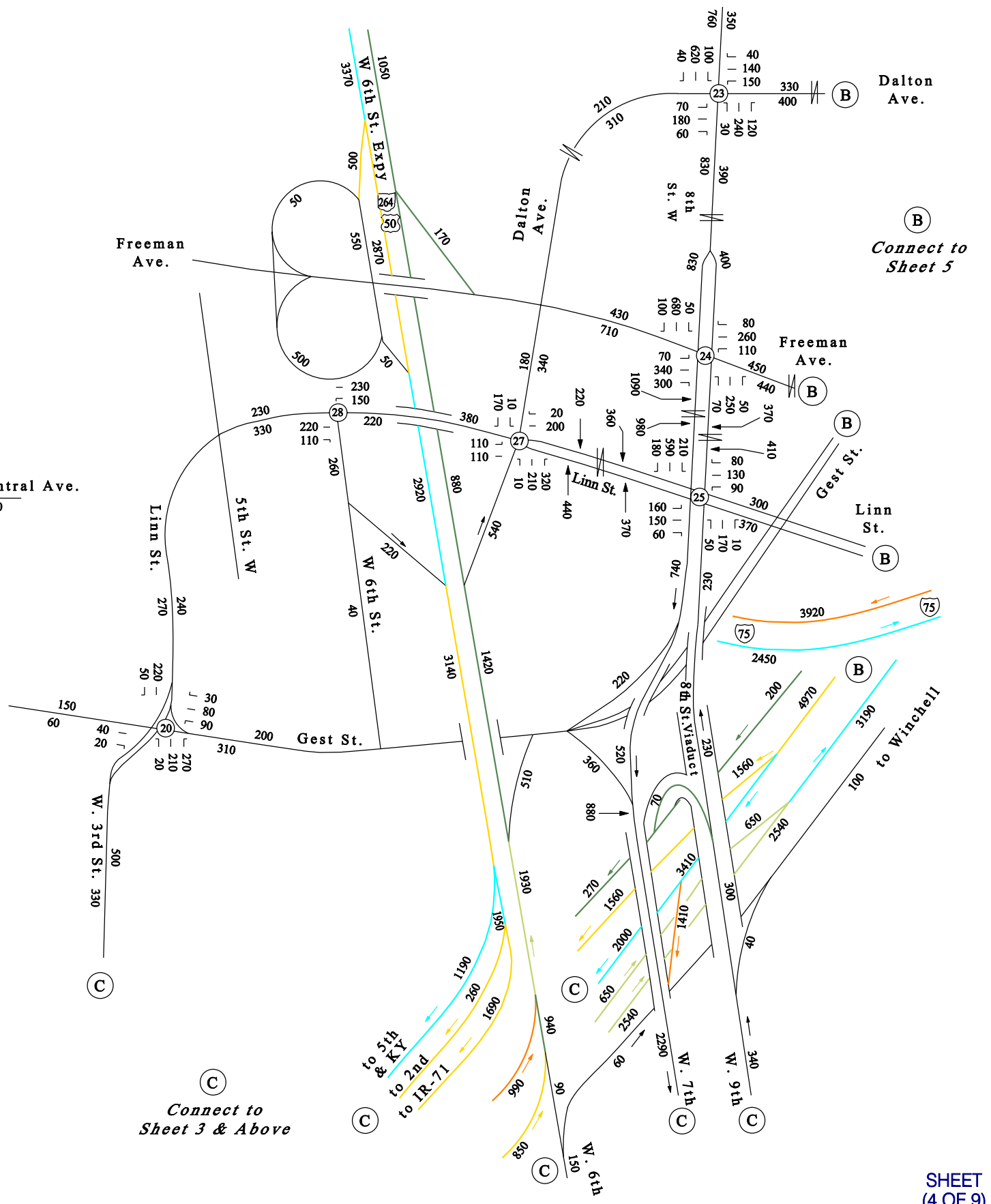
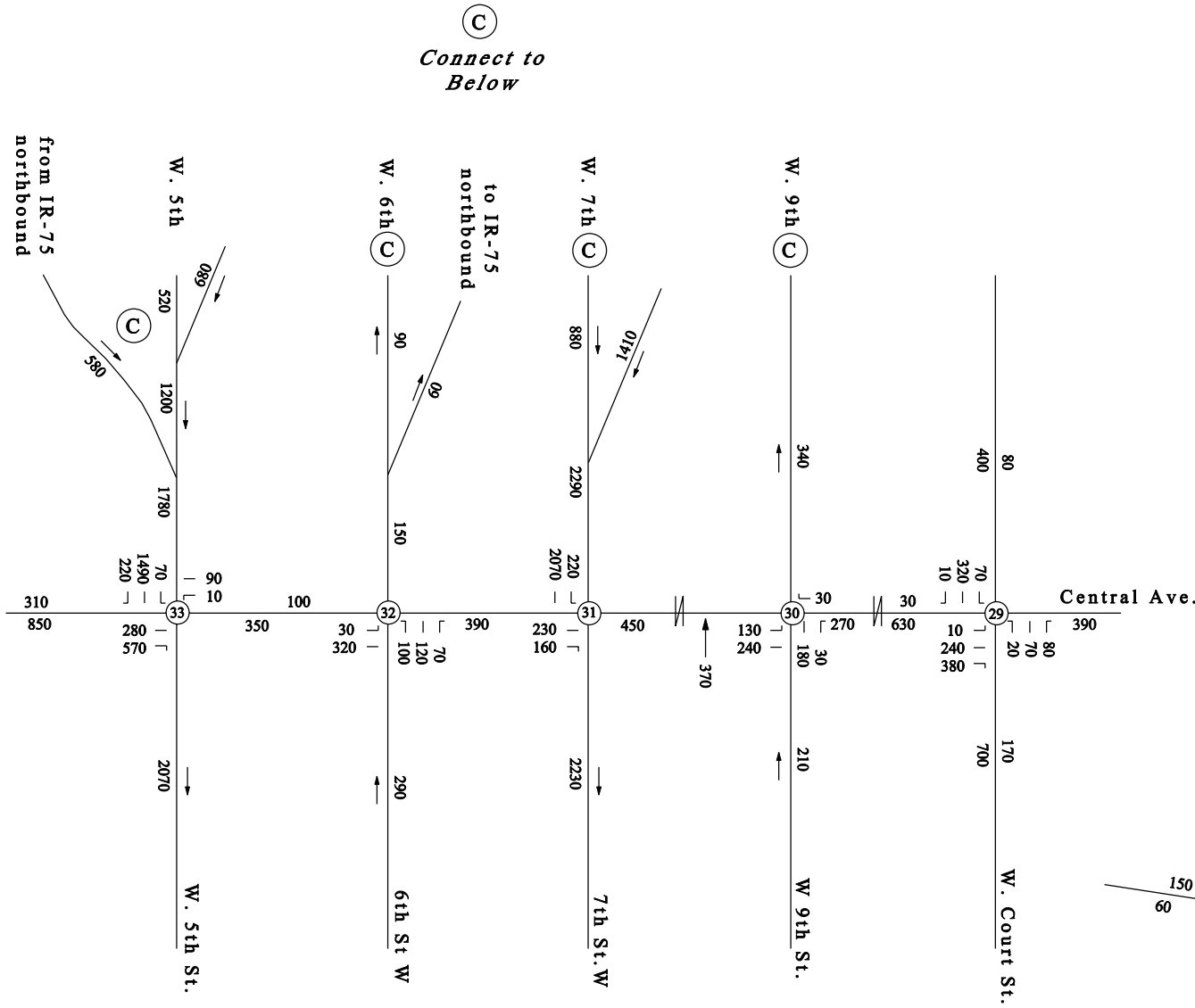

**LEGEND**

- Level of Service A
- Level of Service B
- Level of Service C
- Level of Service D
- Level of Service E
- Level of Service F
- 2569 # of Vehicles per Hour
- 12 Intersection ID #

NOT TO SCALE





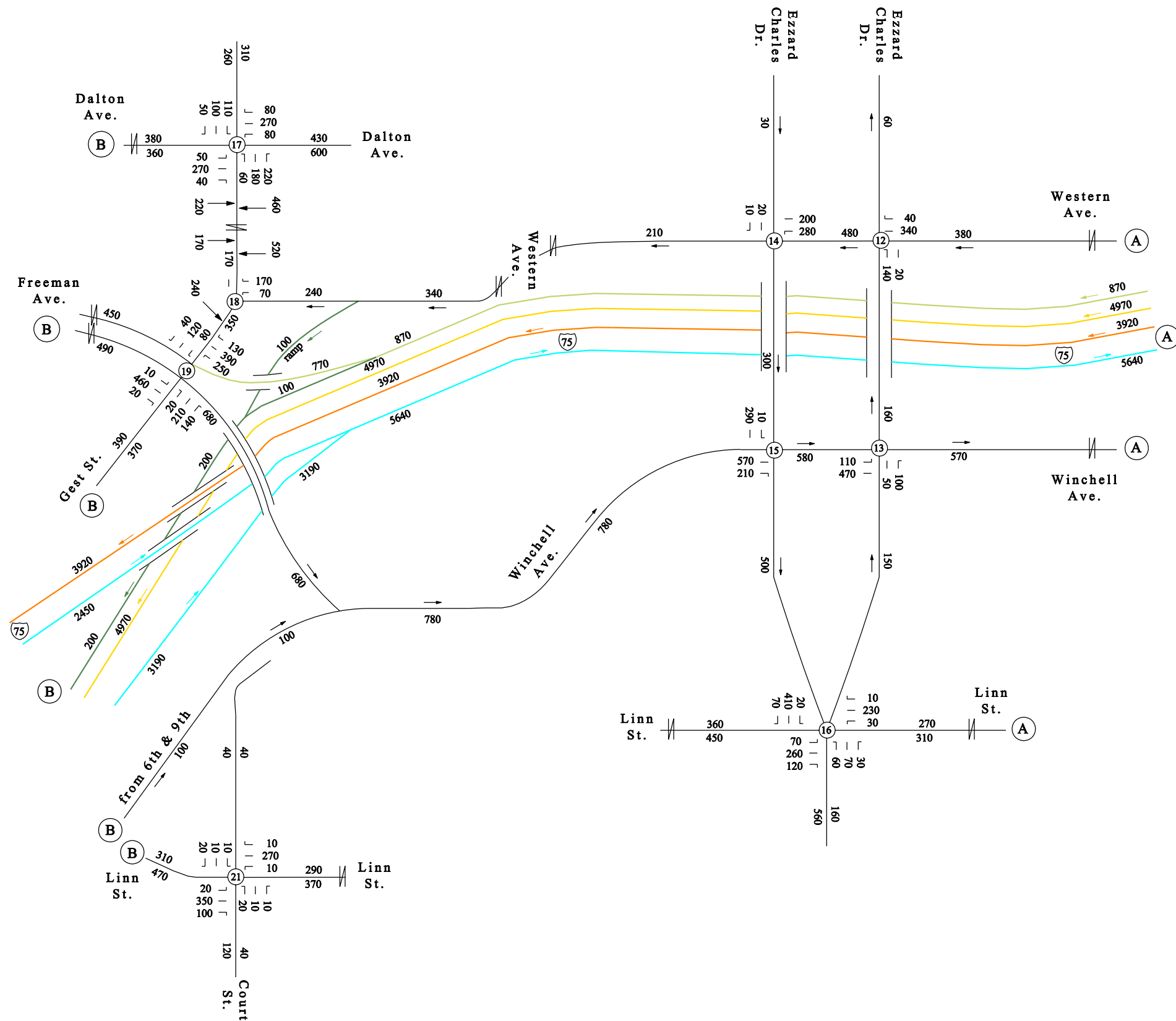

(B) Connect to Sheet 4

(A) Connect to Sheet 6

**LEGEND**

- Level of Service A
- Level of Service B
- Level of Service C
- Level of Service D
- Level of Service E
- Level of Service F
- 2569 # of Vehicles per Hour
- (12) Intersection ID #

NOT TO SCALE



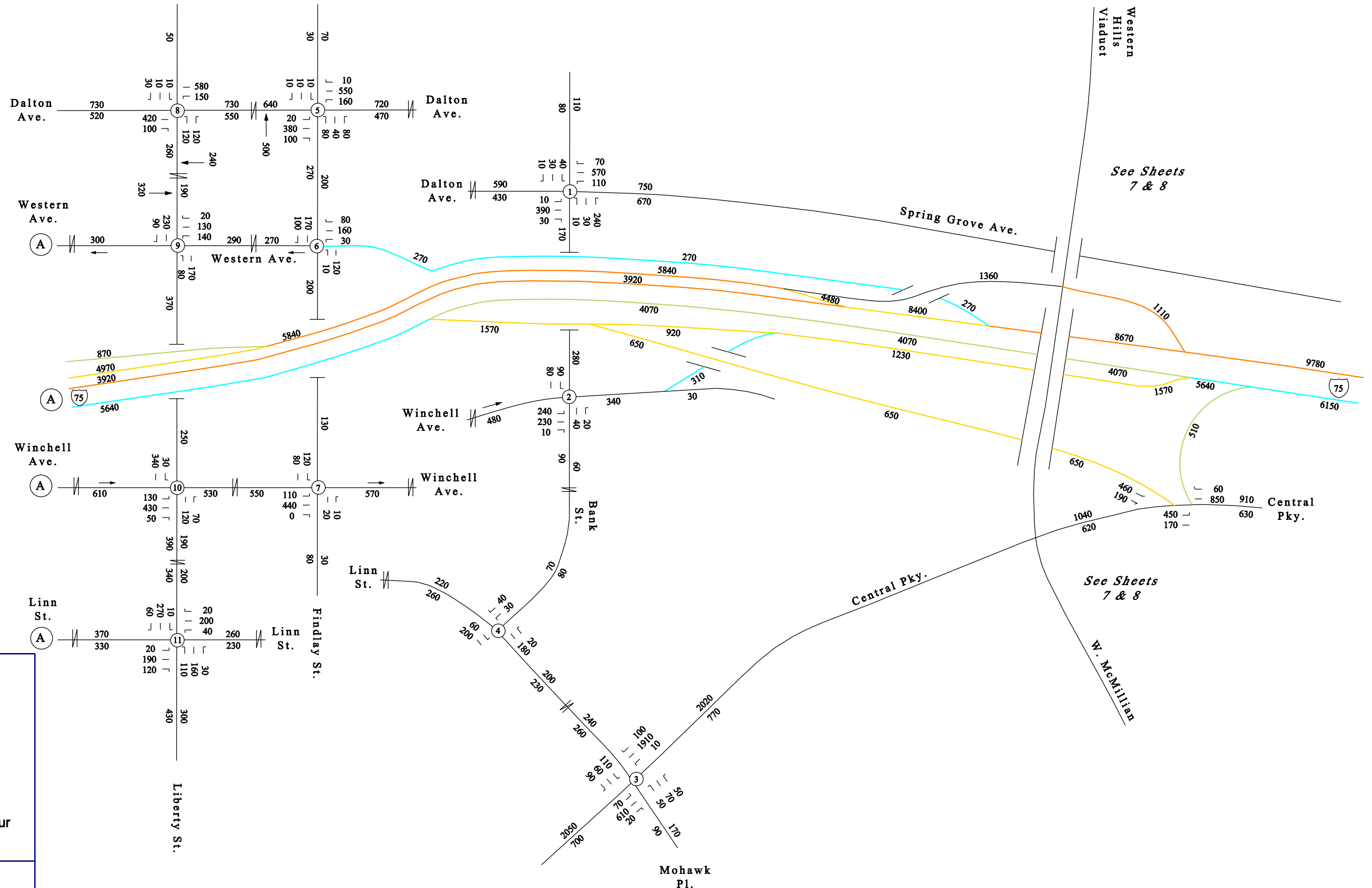

(A) Connect to Sheet 5

**LEGEND**

- Level of Service A
- Level of Service B
- Level of Service C
- Level of Service D
- Level of Service E
- Level of Service F
- 2569 # of Vehicles per Hour
- (12) Intersection ID #

NOT TO SCALE



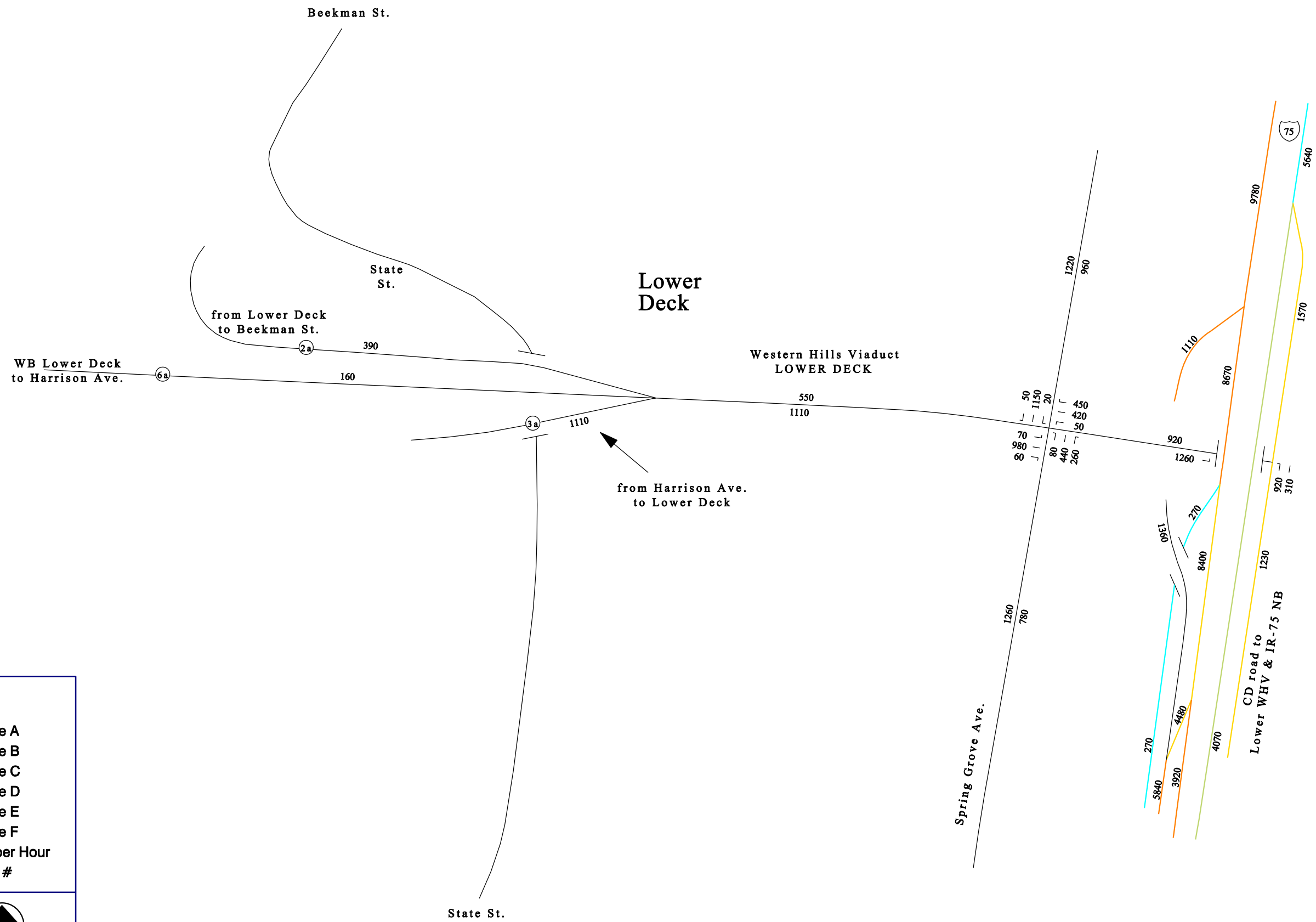

**LEGEND**

- Level of Service A
- Level of Service B
- Level of Service C
- Level of Service D
- Level of Service E
- Level of Service F
- 2569 # of Vehicles per Hour
- (12) Intersection ID #

NOT TO SCALE



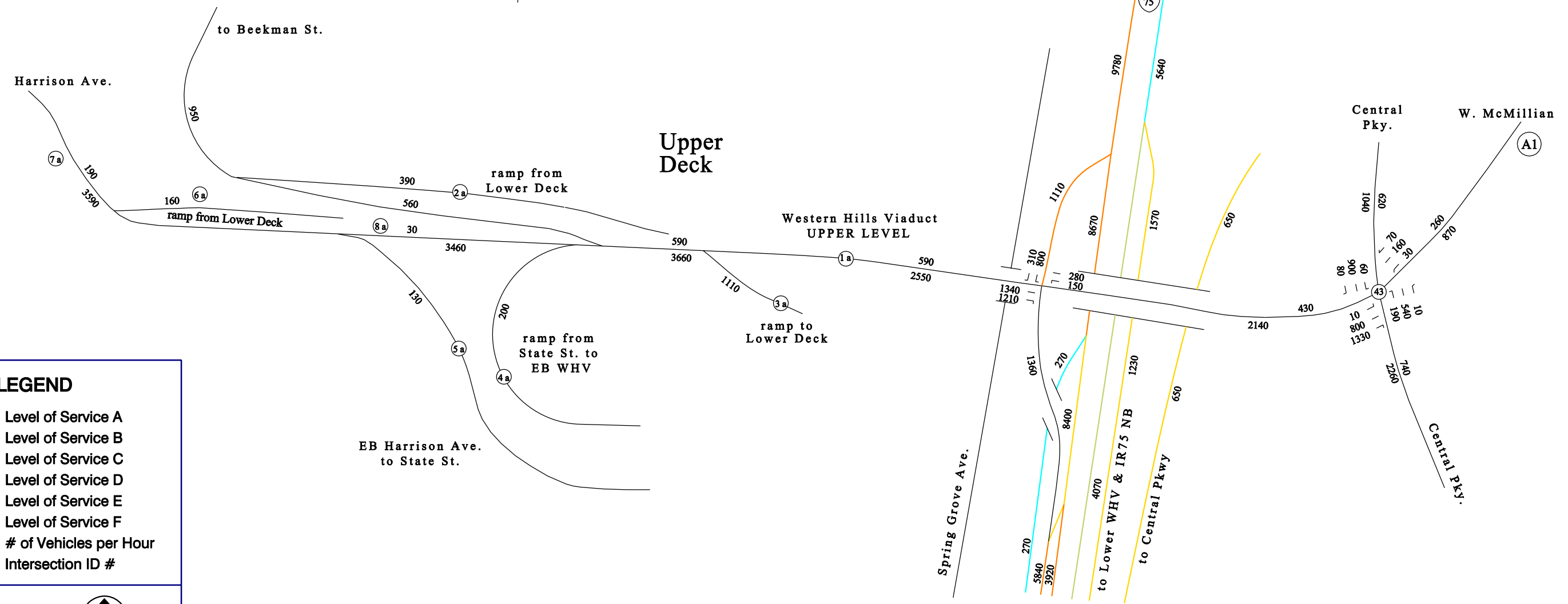
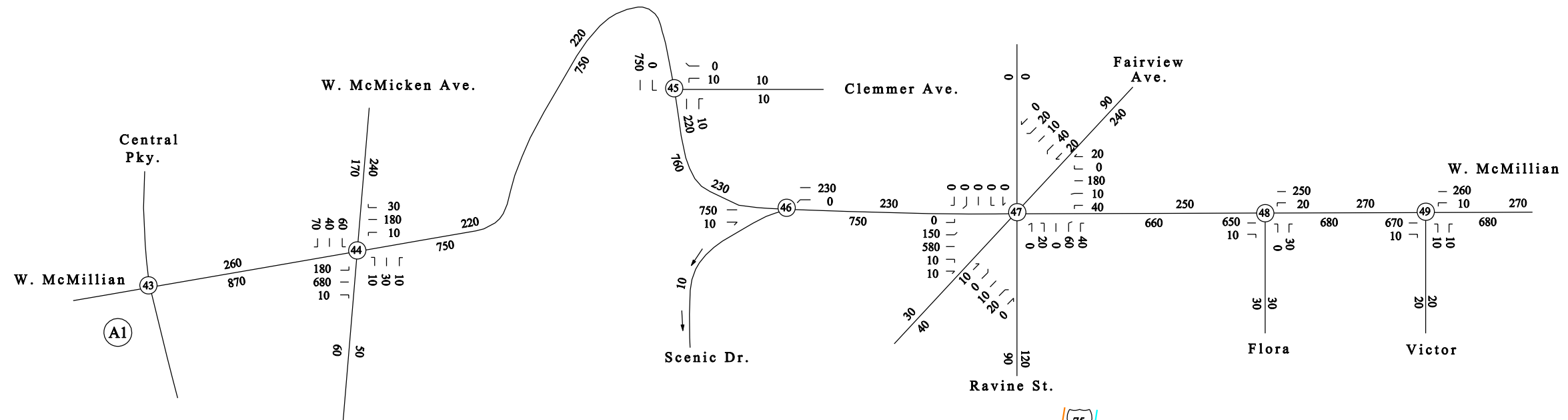

**LEGEND**

- Level of Service A
  - Level of Service B
  - Level of Service C
  - Level of Service D
  - Level of Service E
  - Level of Service F
- 2569 # of Vehicles per Hour
- (12) Intersection ID #

NOT TO SCALE



**2035 AM LEVEL OF SERVICE  
ALTERNATIVE B  
(OHIO)**

SHEET  
(8 OF 9)

**EXHIBIT  
A3-H**

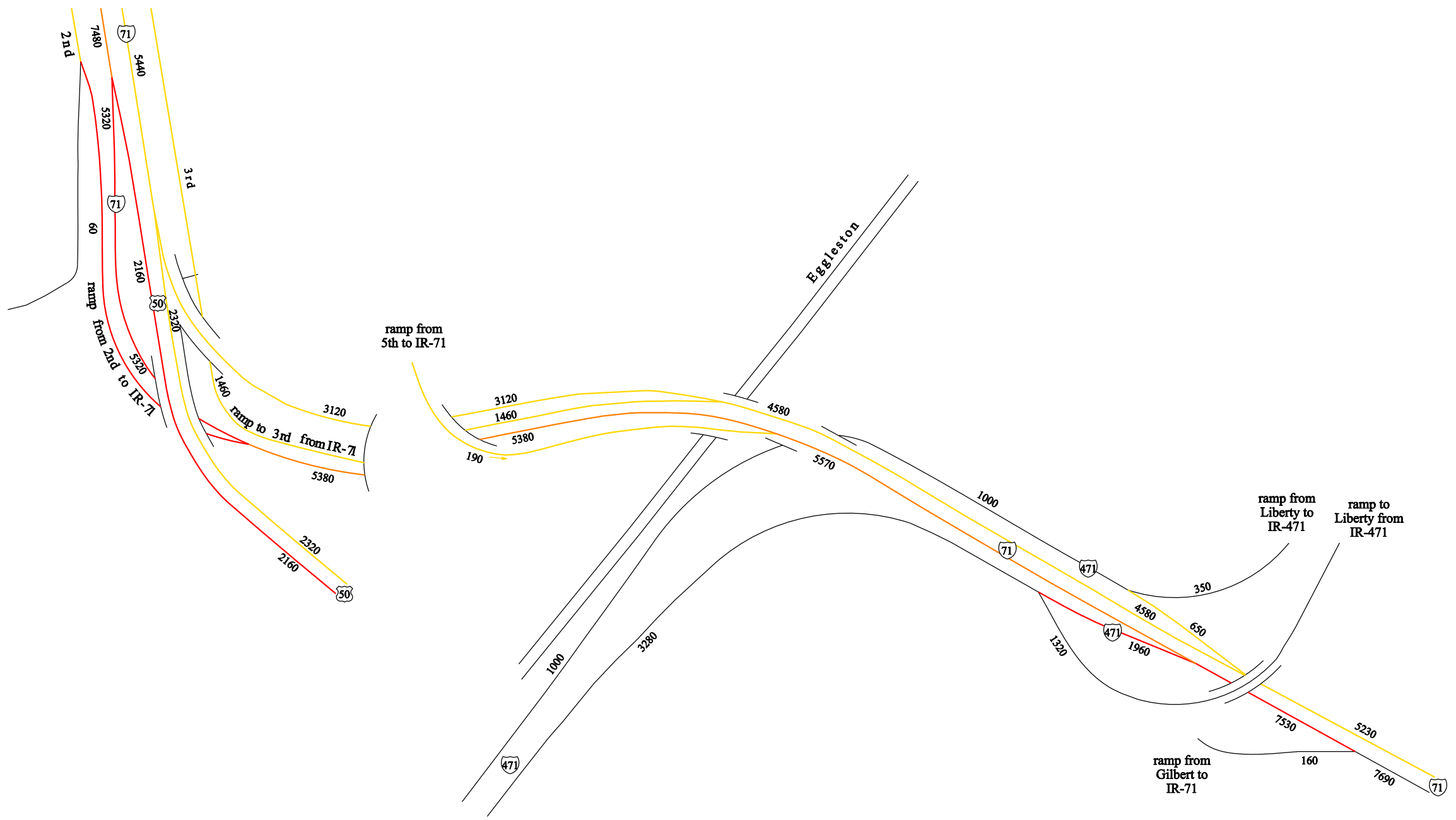

**LEGEND**

- Level of Service A
- Level of Service B
- Level of Service C
- Level of Service D
- Level of Service E
- Level of Service F
- 2569 # of Vehicles per Hour
- (12) Intersection ID #

NOT TO SCALE



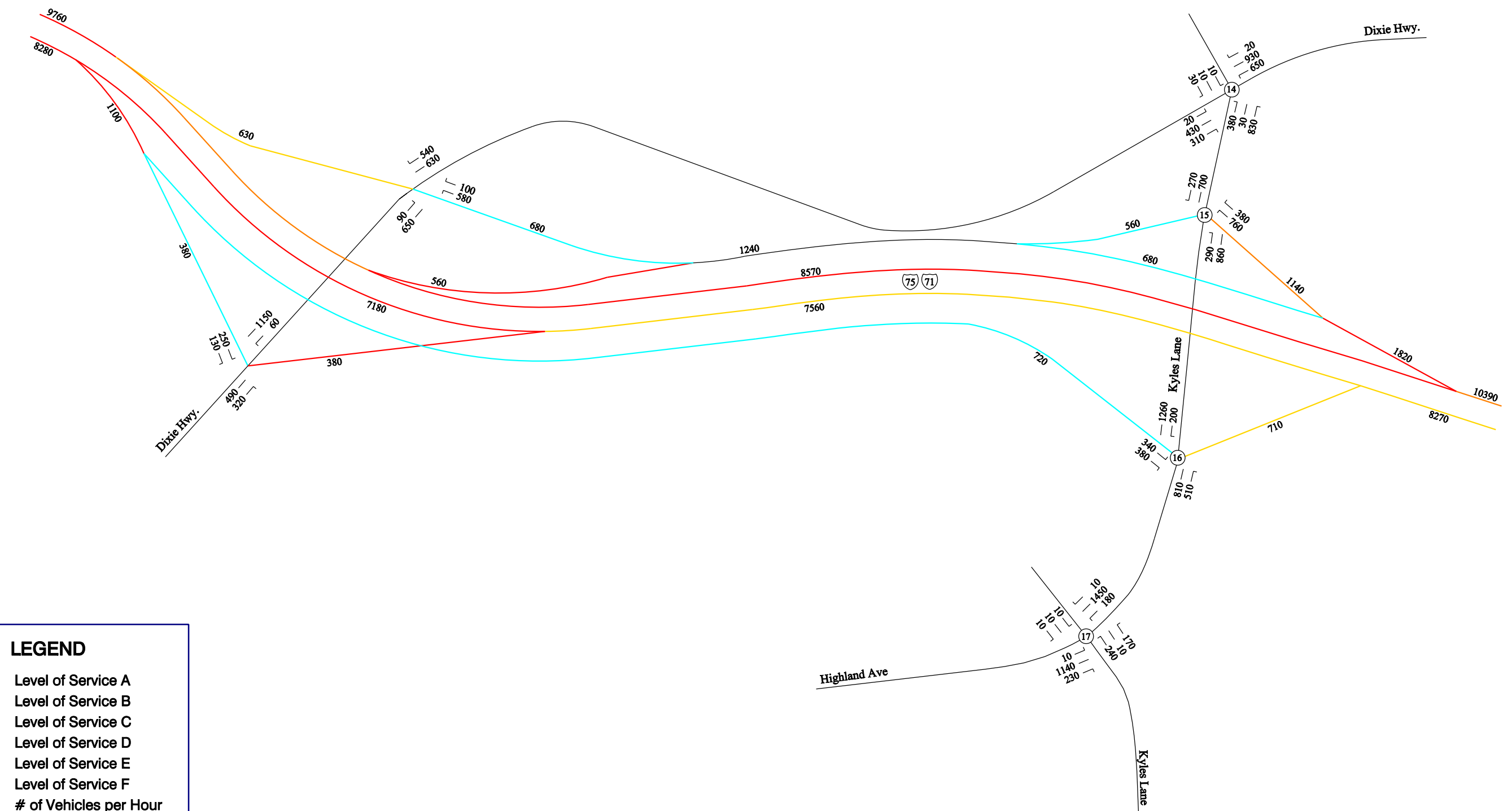

**LEGEND**

- Level of Service A
- Level of Service B
- Level of Service C
- Level of Service D
- Level of Service E
- Level of Service F
- 2569 # of Vehicles per Hour
- (12) Intersection ID #

NOT TO SCALE



**2035 PM LEVEL OF SERVICE  
ALTERNATIVE B  
(KENTUCKY)**

SHEET  
(1 OF 9)

**EXHIBIT  
A4-A**

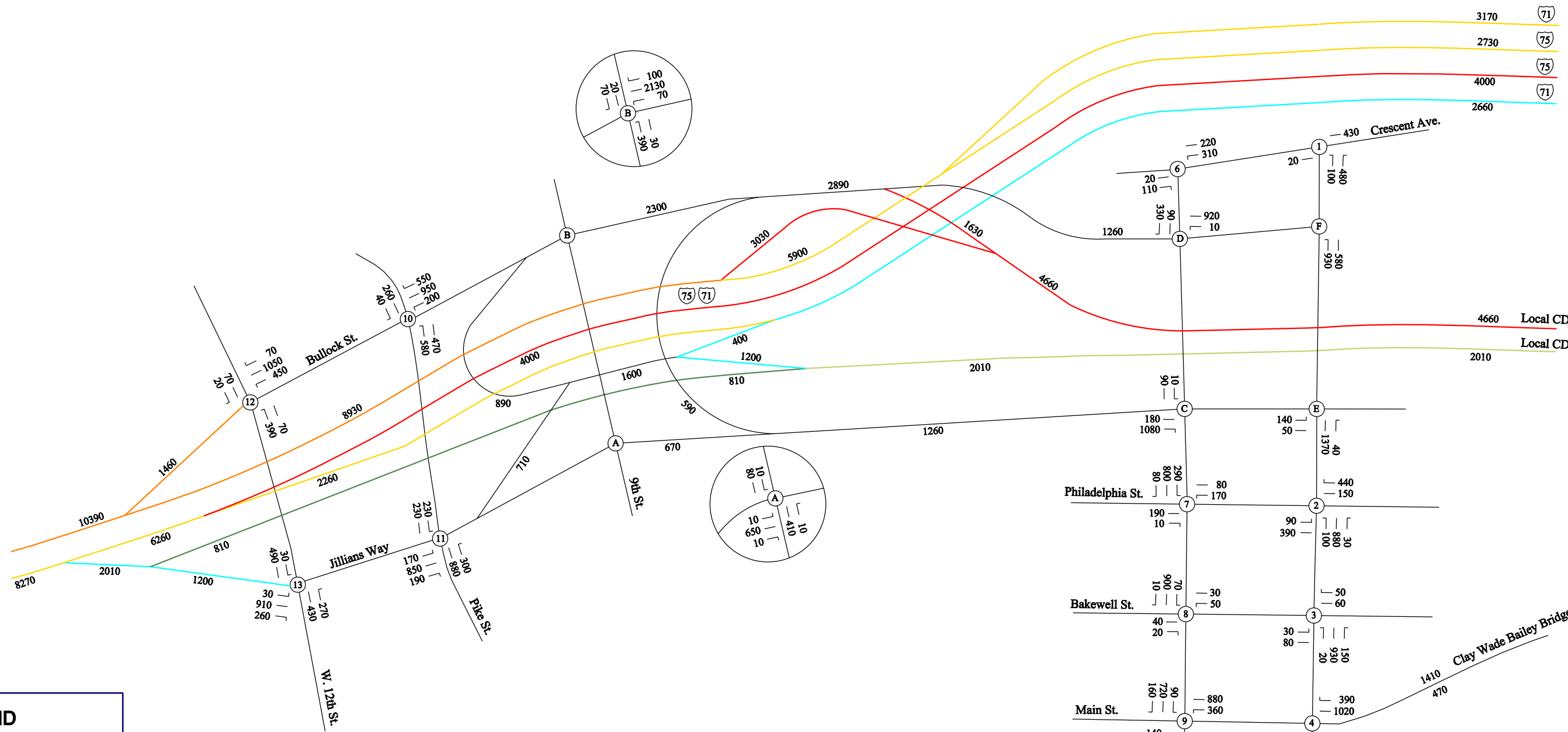

**LEGEND**

- Level of Service A
- Level of Service B
- Level of Service C
- Level of Service D
- Level of Service E
- Level of Service F
- 2569 # of Vehicles per Hour
- (12) Intersection ID #

NOT TO SCALE



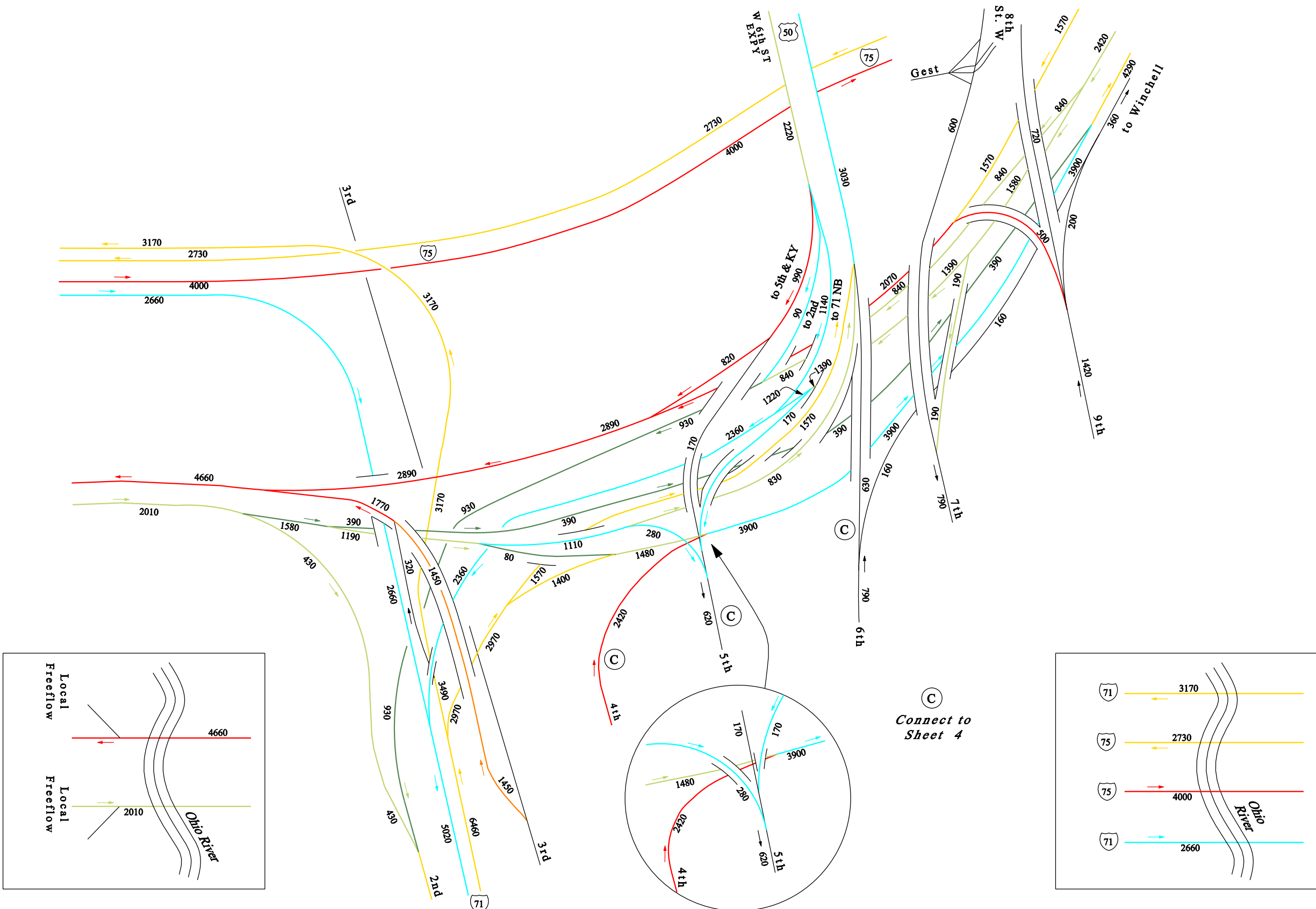

**LEGEND**

- Level of Service A
  - Level of Service B
  - Level of Service C
  - Level of Service D
  - Level of Service E
  - Level of Service F
- 2569 # of Vehicles per Hour  
 (12) Intersection ID #

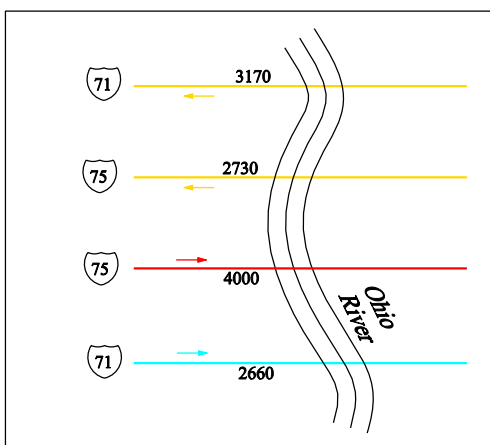
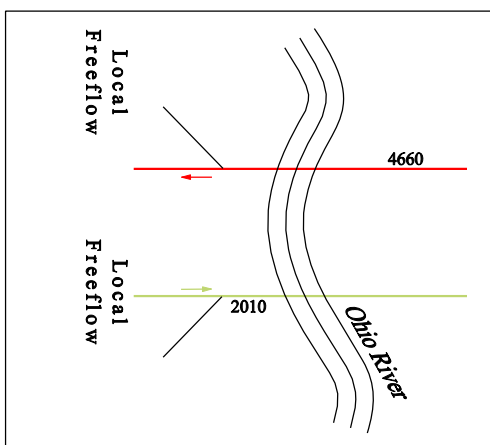

NOT TO SCALE



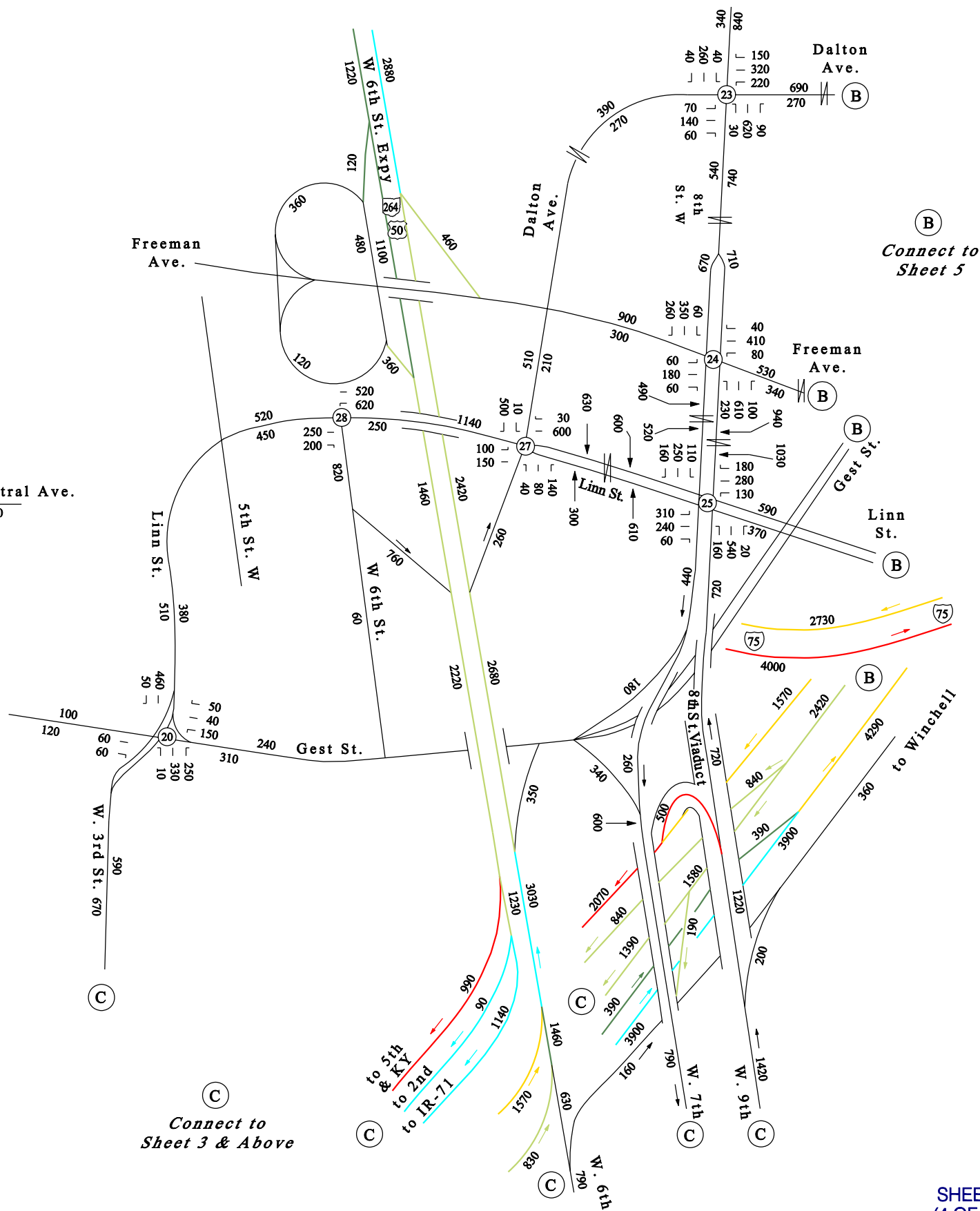
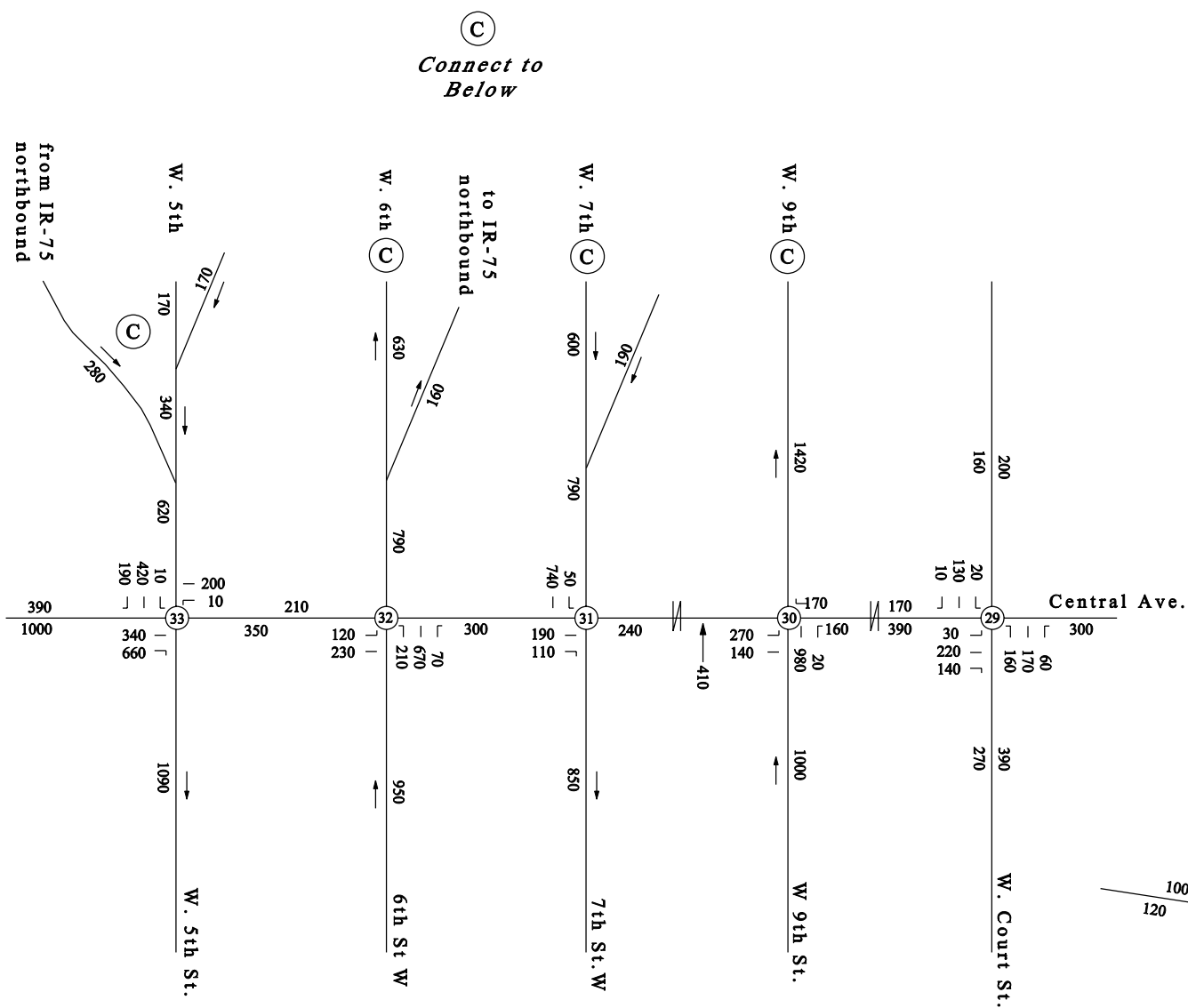

**LEGEND**

- Level of Service A
- Level of Service B
- Level of Service C
- Level of Service D
- Level of Service E
- Level of Service F
- 2569 # of Vehicles per Hour
- 12 Intersection ID #

NOT TO SCALE



Connect to Below

Connect to Sheet 5

Connect to Sheet 3 & Above



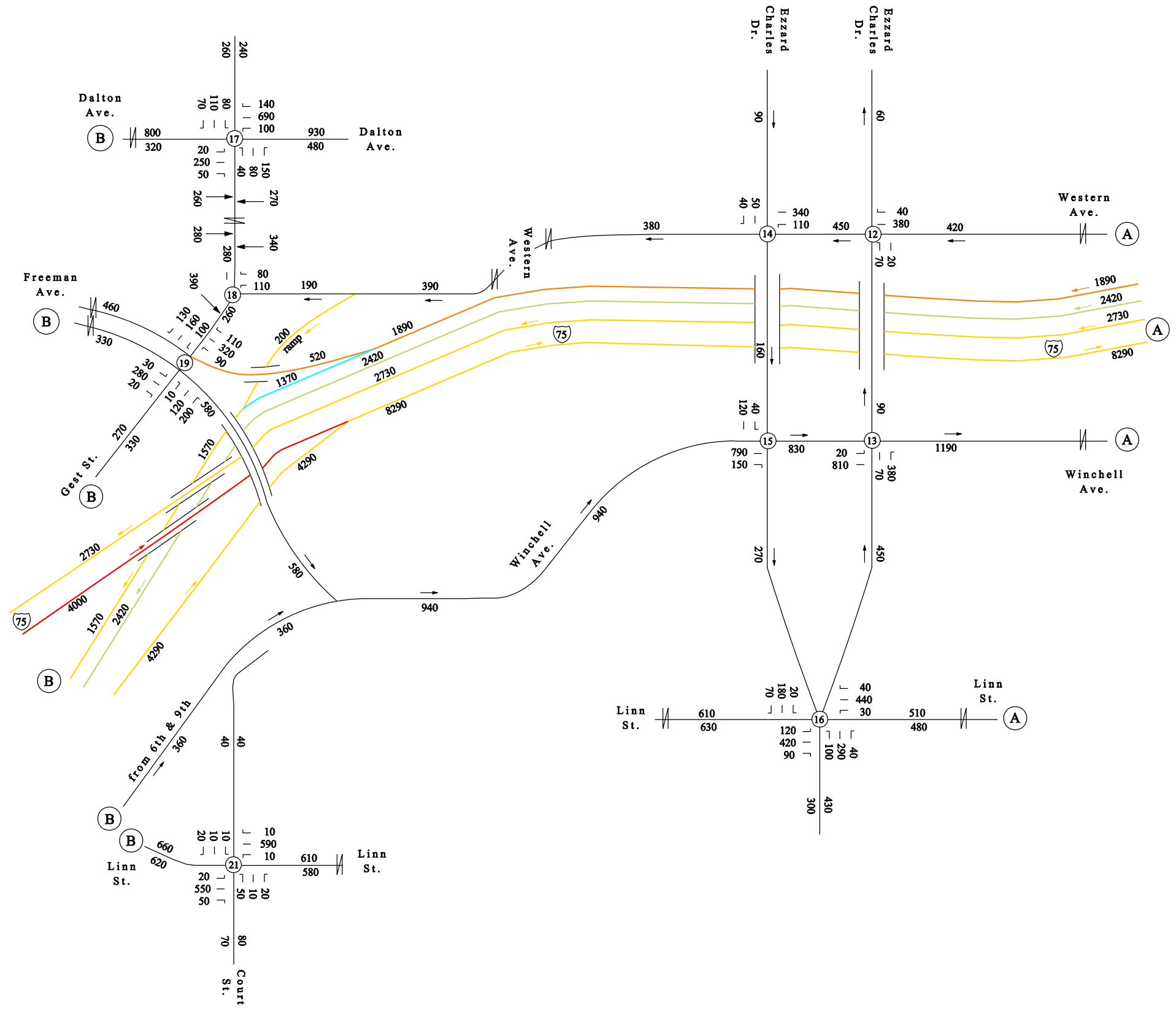

**LEGEND**

- Level of Service A
- Level of Service B
- Level of Service C
- Level of Service D
- Level of Service E
- Level of Service F
- 2569 # of Vehicles per Hour
- (12) Intersection ID #

NOT TO SCALE



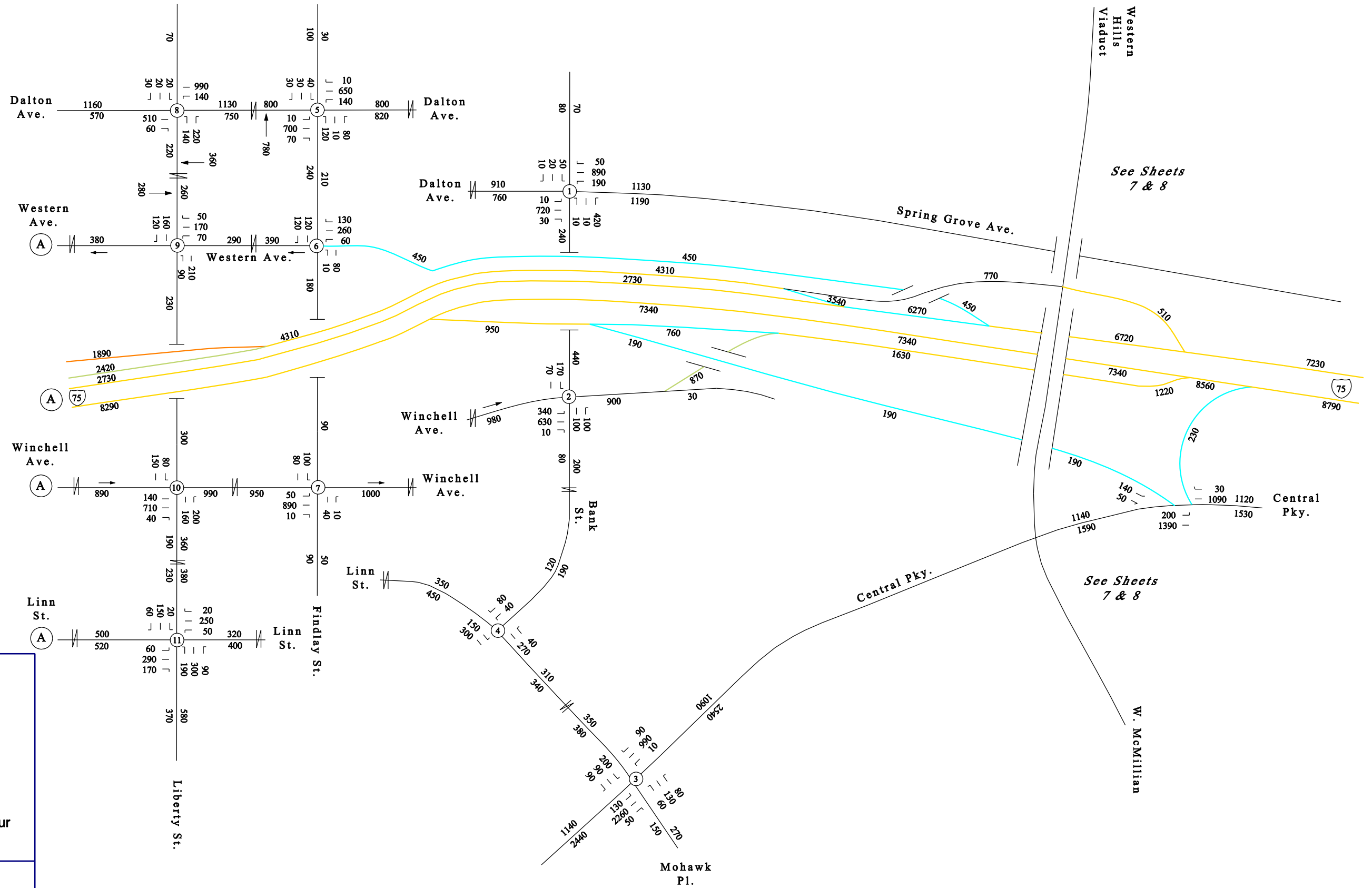

A  
Connect to  
Sheet 5

See Sheets  
7 & 8

See Sheets  
7 & 8

**LEGEND**

- Level of Service A
- Level of Service B
- Level of Service C
- Level of Service D
- Level of Service E
- Level of Service F
- 2569 # of Vehicles per Hour
- (12) Intersection ID #

NOT TO SCALE



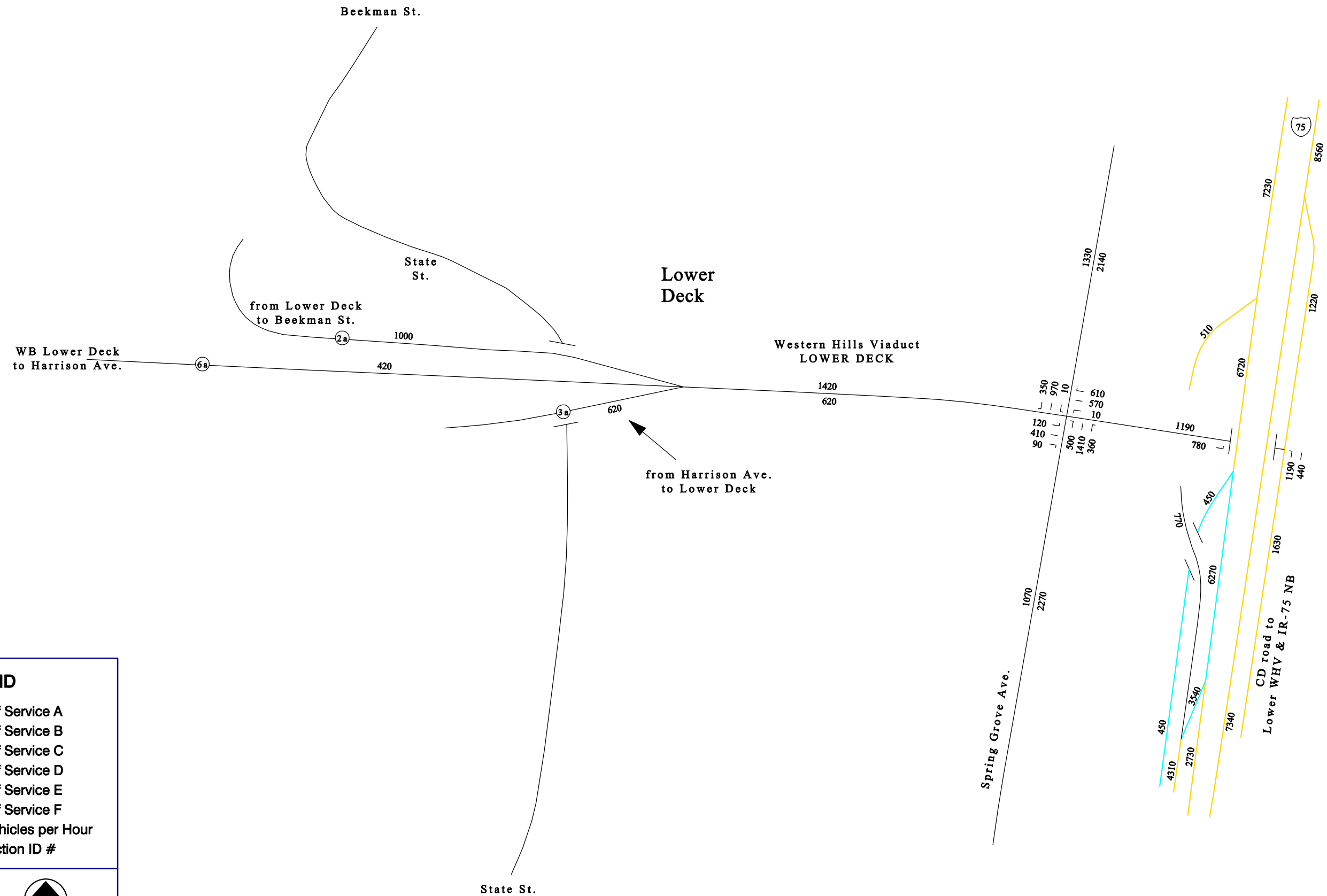

**LEGEND**

- Level of Service A
- Level of Service B
- Level of Service C
- Level of Service D
- Level of Service E
- Level of Service F
- 2569 # of Vehicles per Hour
- (12) Intersection ID #

NOT TO SCALE



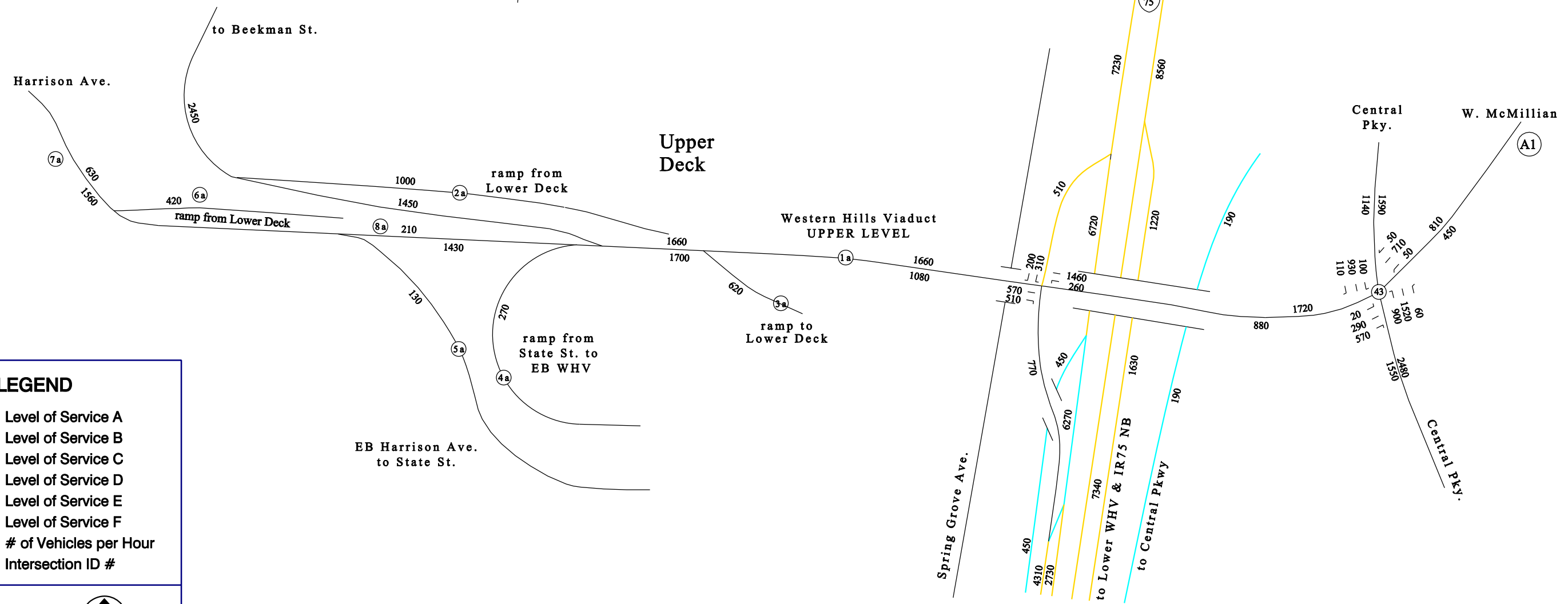
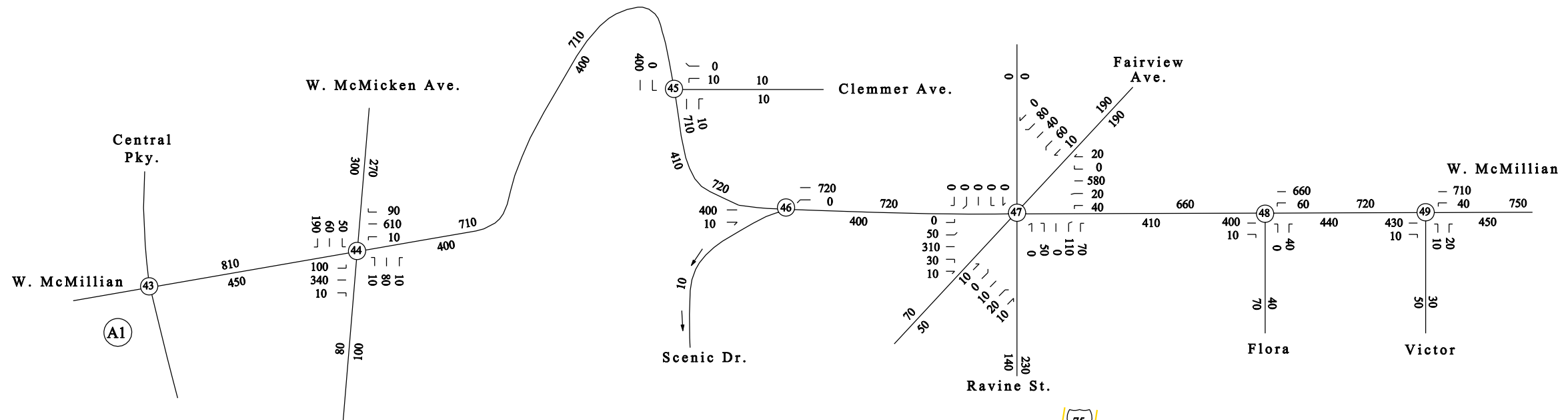

**LEGEND**

- Level of Service A
- Level of Service B
- Level of Service C
- Level of Service D
- Level of Service E
- Level of Service F
- 2569 # of Vehicles per Hour
- (12) Intersection ID #

NOT TO SCALE



**2035 PM LEVEL OF SERVICE  
ALTERNATIVE B  
(OHIO)**

SHEET  
(8 OF 9)

**EXHIBIT  
A4-H**

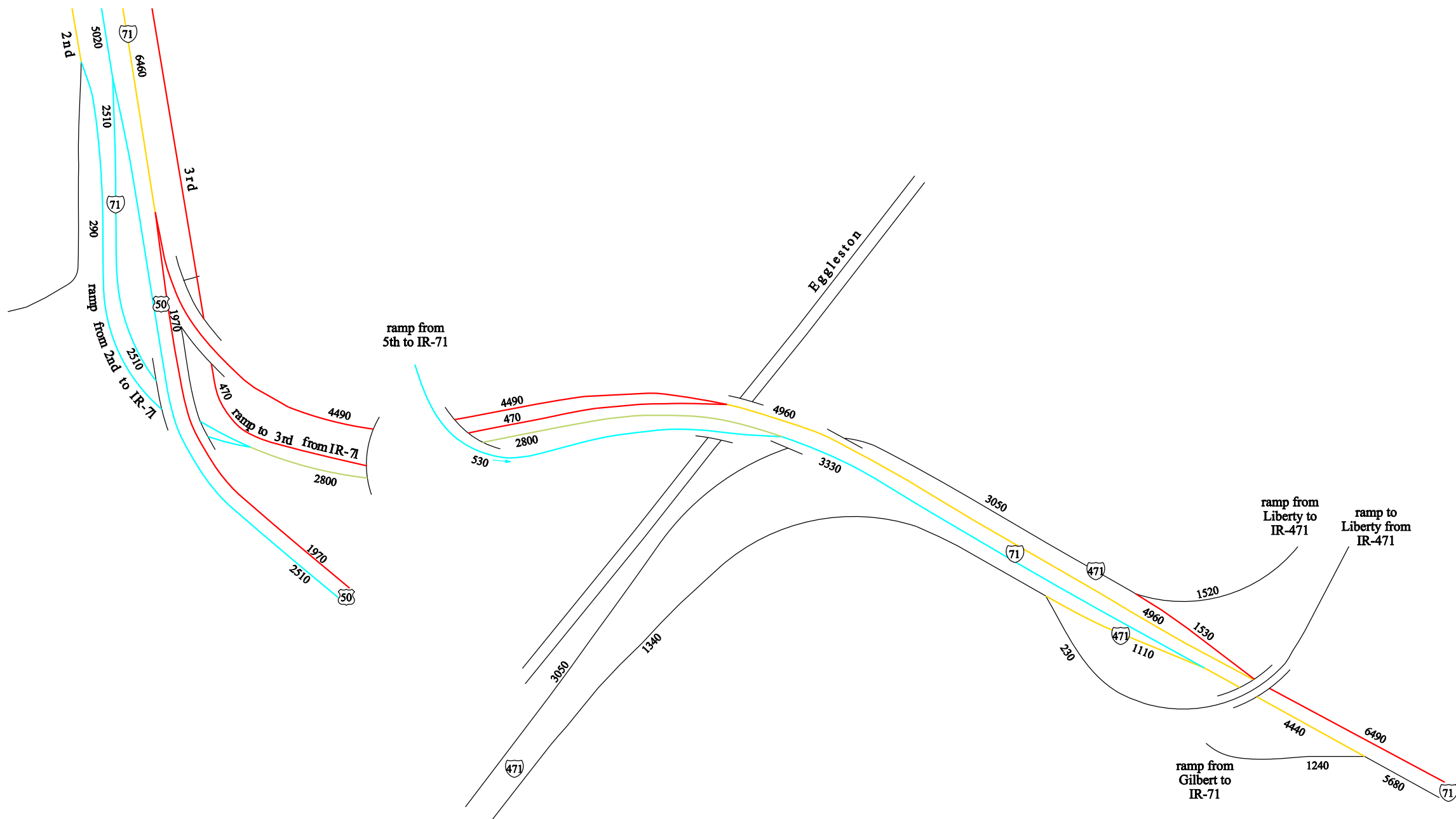

**LEGEND**

- Level of Service A
- Level of Service B
- Level of Service C
- Level of Service D
- Level of Service E
- Level of Service F
- 2569 # of Vehicles per Hour
- (12) Intersection ID #

NOT TO SCALE



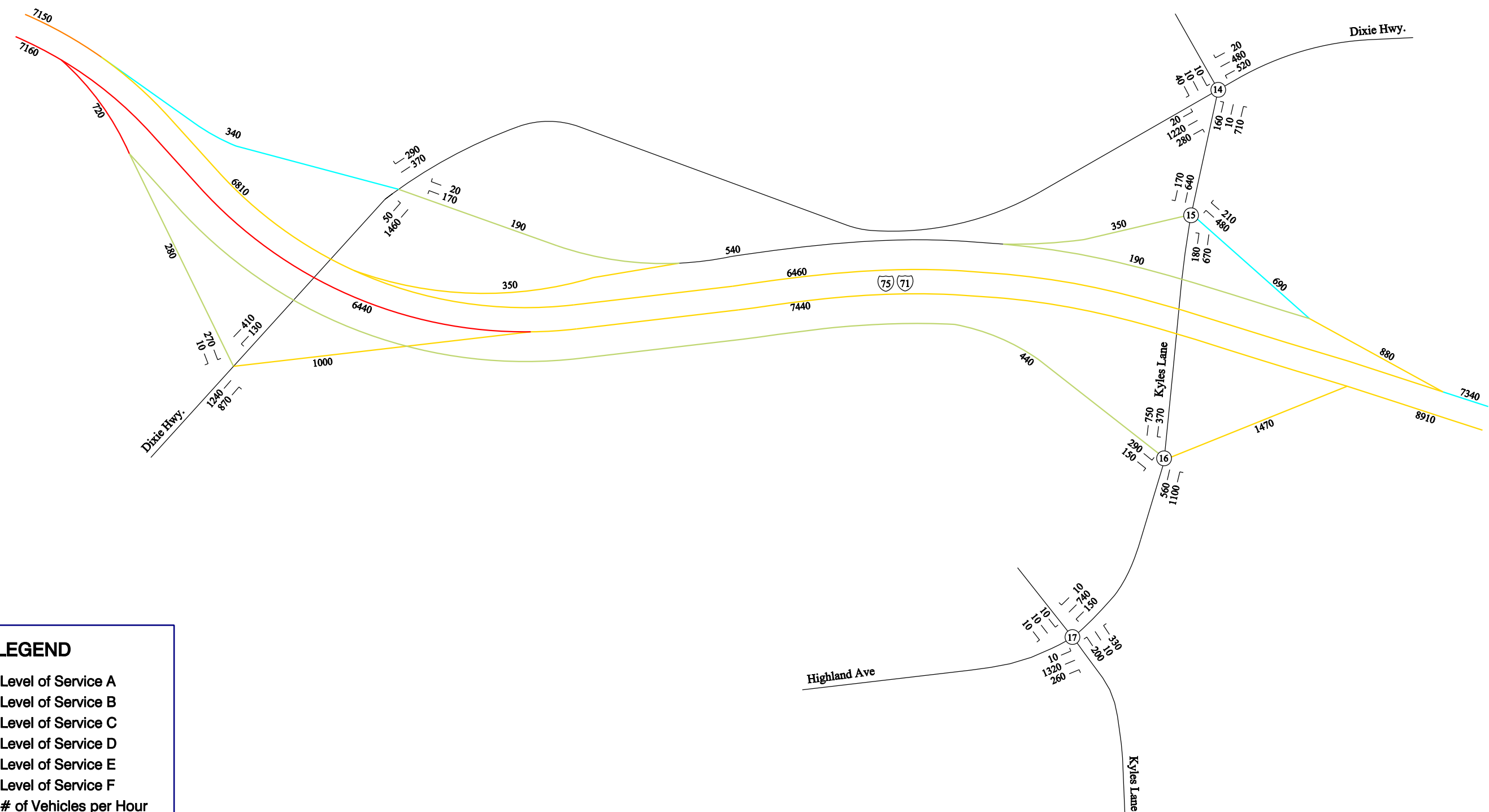

**LEGEND**

- Level of Service A
  - Level of Service B
  - Level of Service C
  - Level of Service D
  - Level of Service E
  - Level of Service F
- 2569 # of Vehicles per Hour
- (12) Intersection ID #

NOT TO SCALE



**2035 AM LEVEL OF SERVICE  
ALTERNATIVE C  
(KENTUCKY)**

SHEET  
(1 OF 9)

**EXHIBIT  
A5-A**

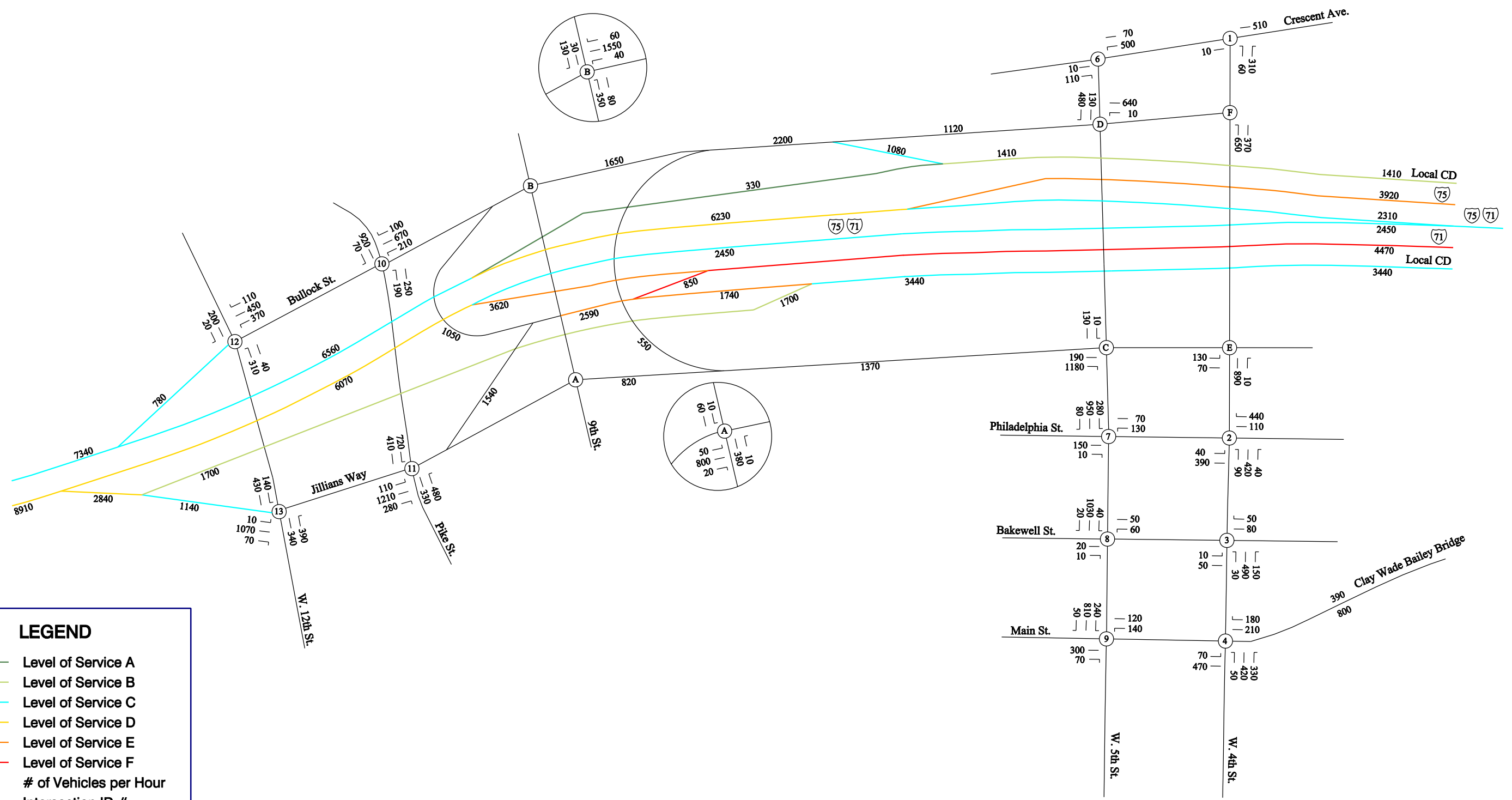

**LEGEND**

- Level of Service A
- Level of Service B
- Level of Service C
- Level of Service D
- Level of Service E
- Level of Service F
- 2569 # of Vehicles per Hour
- (12) Intersection ID #

NOT TO SCALE



**2035 AM LEVEL OF SERVICE  
ALTERNATIVE C  
(KENTUCKY)**

SHEET  
(2 OF 9)

**EXHIBIT  
A5-B**



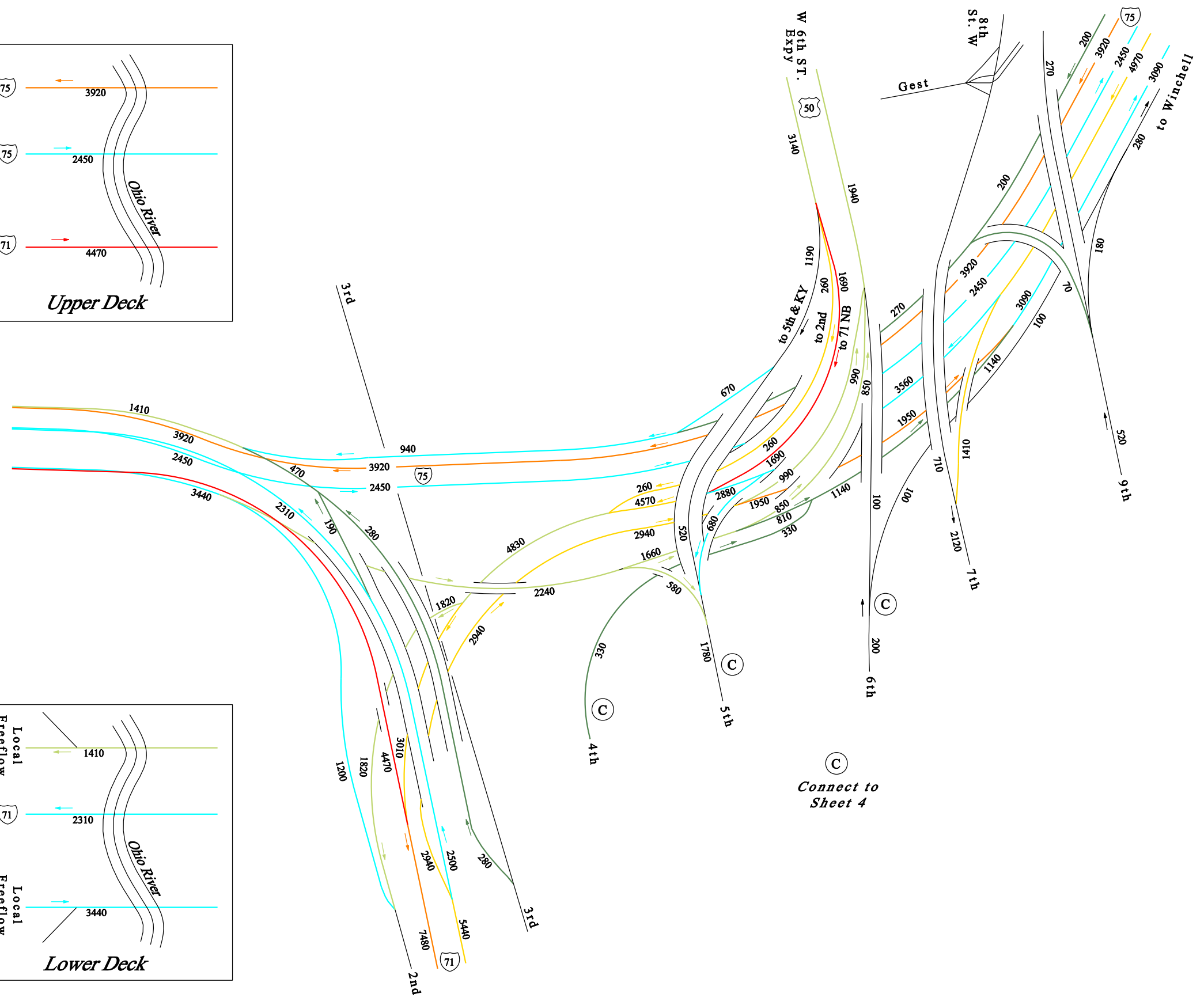
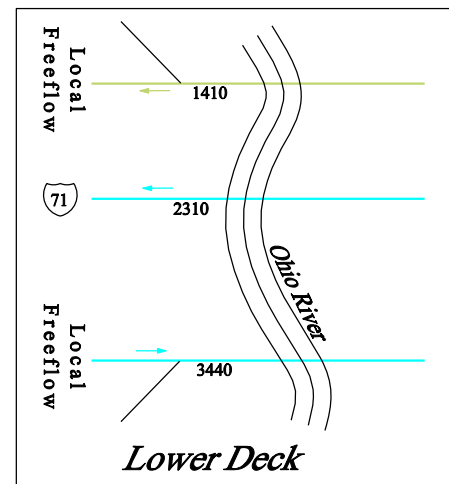
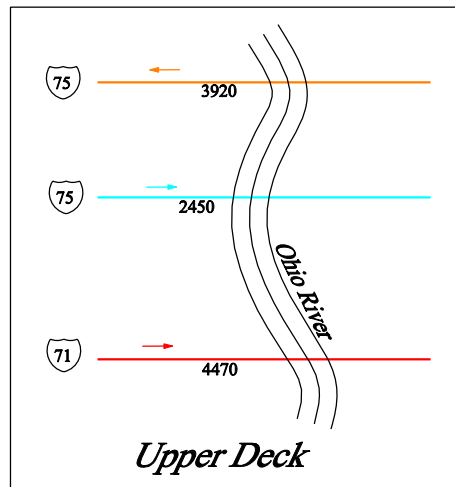

**LEGEND**

- Level of Service A
  - Level of Service B
  - Level of Service C
  - Level of Service D
  - Level of Service E
  - Level of Service F
- 2569 # of Vehicles per Hour  
 (12) Intersection ID #

NOT TO SCALE



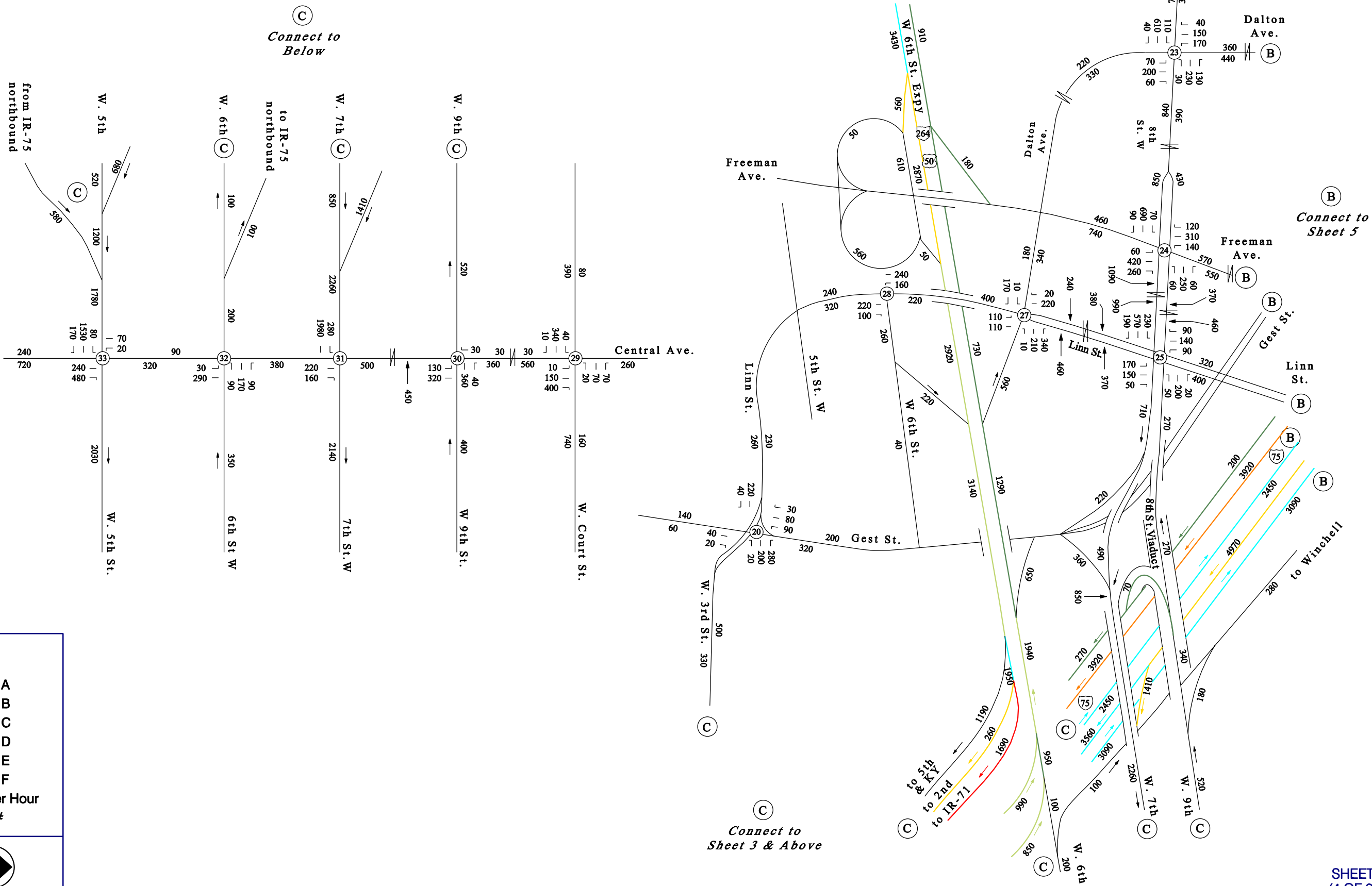

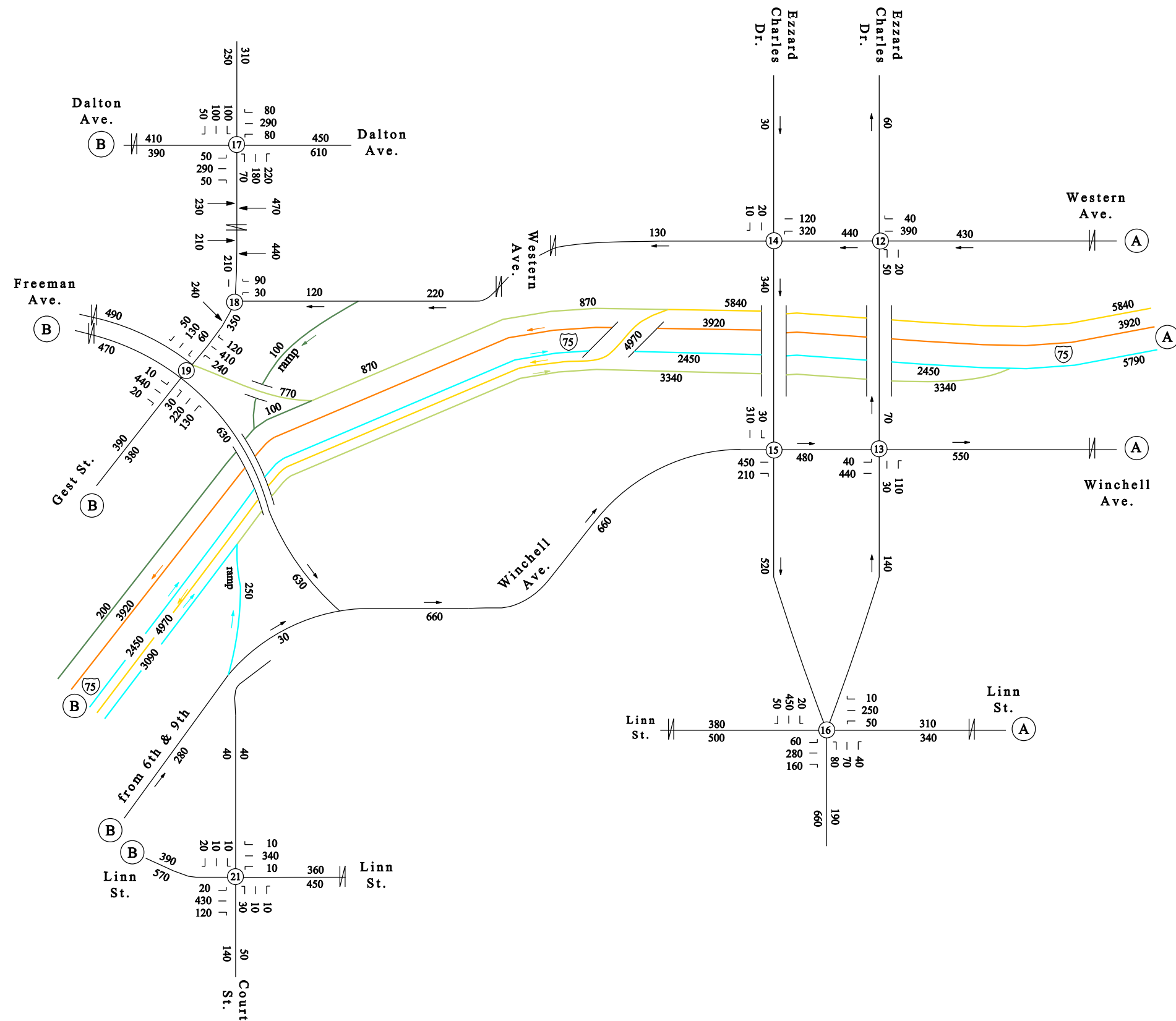

**LEGEND**

- Level of Service A
- Level of Service B
- Level of Service C
- Level of Service D
- Level of Service E
- Level of Service F
- 2569 # of Vehicles per Hour
- (12) Intersection ID #

NOT TO SCALE



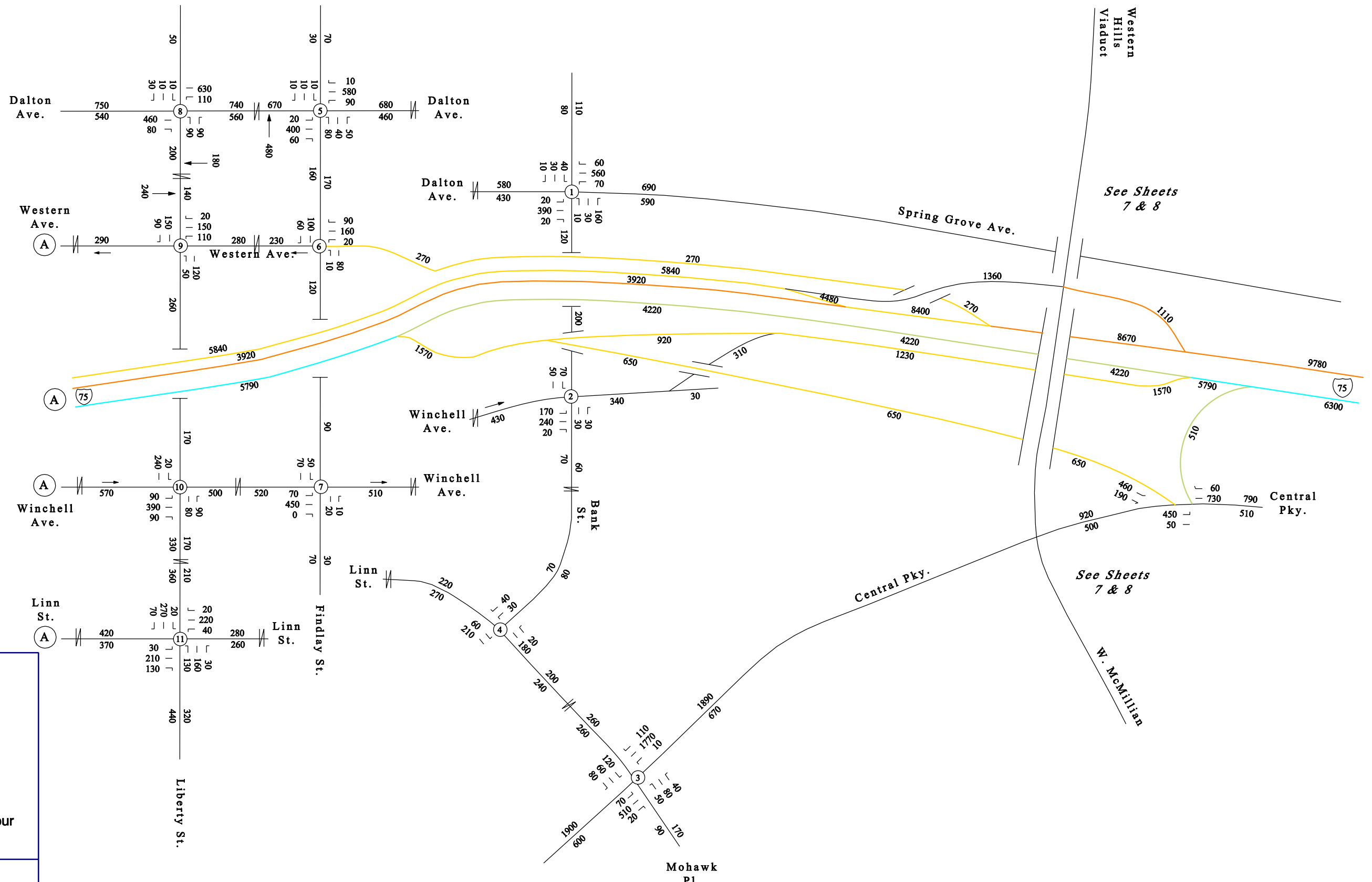

A  
Connect to  
Sheet 5

See Sheets  
7 & 8

See Sheets  
7 & 8

**LEGEND**

- Level of Service A
- Level of Service B
- Level of Service C
- Level of Service D
- Level of Service E
- Level of Service F
- 2569 # of Vehicles per Hour
- (12) Intersection ID #

NOT TO SCALE



**2035 AM LEVEL OF SERVICE  
ALTERNATIVE C  
(OHIO)**

SHEET  
(6 OF 9)

**EXHIBIT  
A5-F**

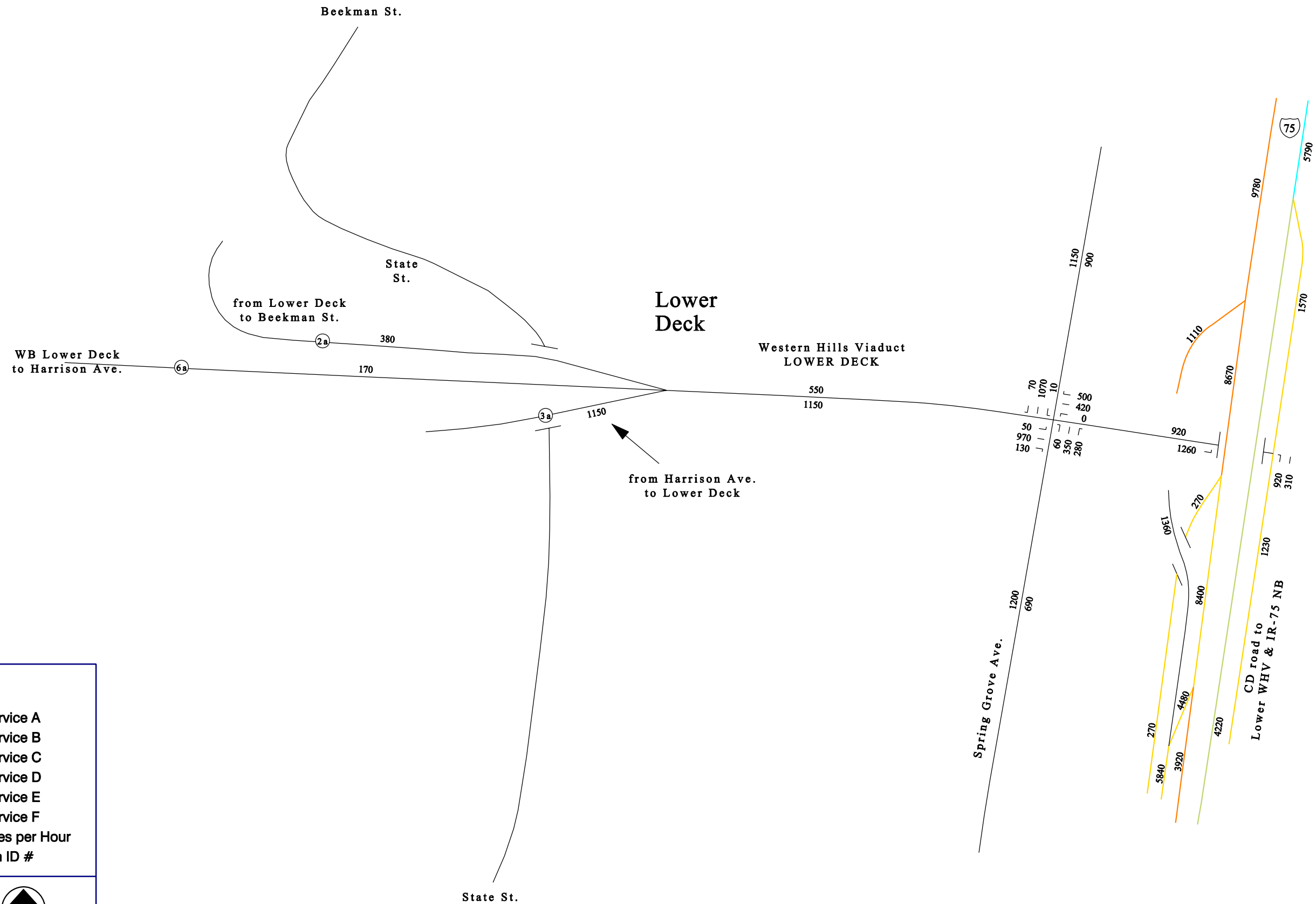

**LEGEND**

- Level of Service A
- Level of Service B
- Level of Service C
- Level of Service D
- Level of Service E
- Level of Service F
- 2569 # of Vehicles per Hour
- (12) Intersection ID #

NOT TO SCALE



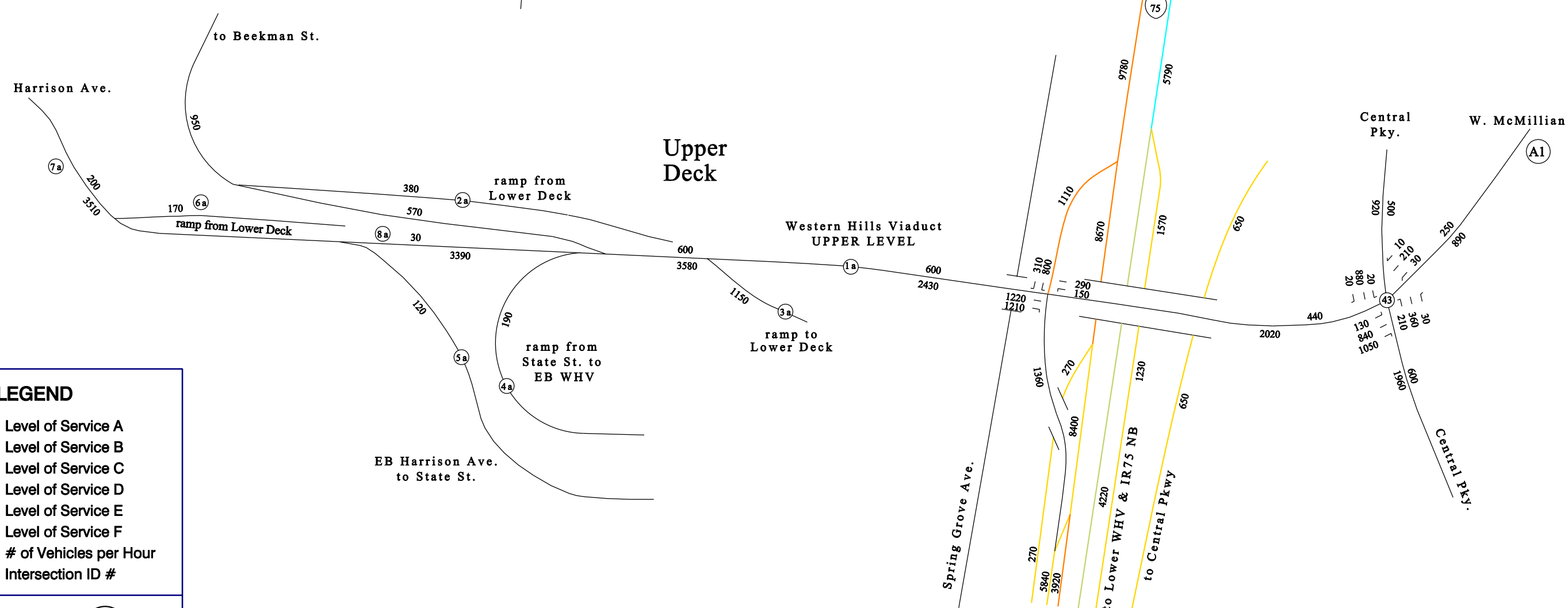
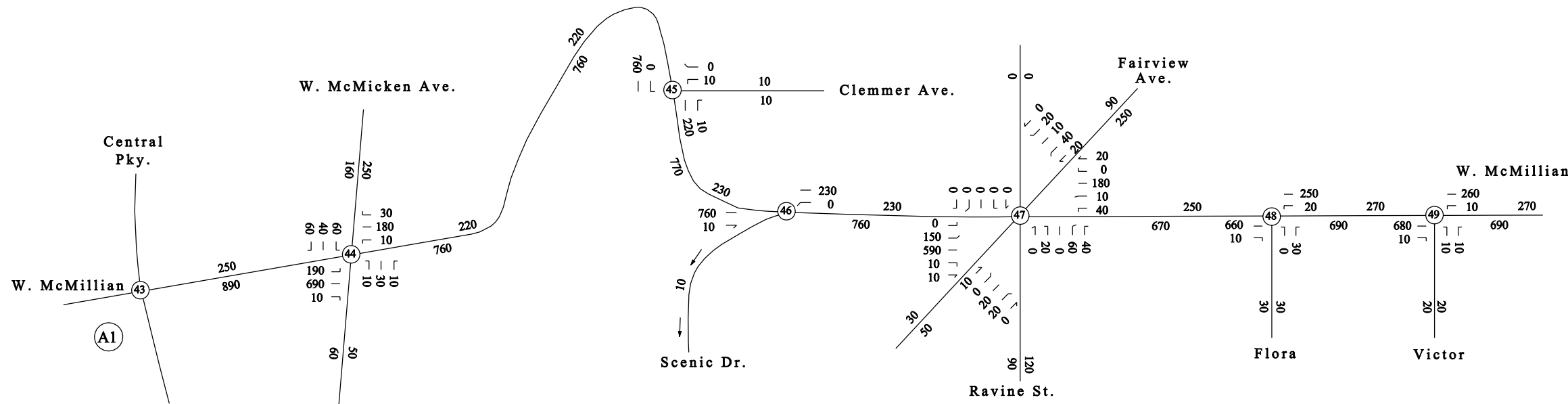

**LEGEND**

- Level of Service A
- Level of Service B
- Level of Service C
- Level of Service D
- Level of Service E
- Level of Service F
- 2569 # of Vehicles per Hour
- (12) Intersection ID #

NOT TO SCALE



**2035 AM LEVEL OF SERVICE  
ALTERNATIVE C  
(OHIO)**

SHEET  
(8 OF 9)

**EXHIBIT  
A5-H**

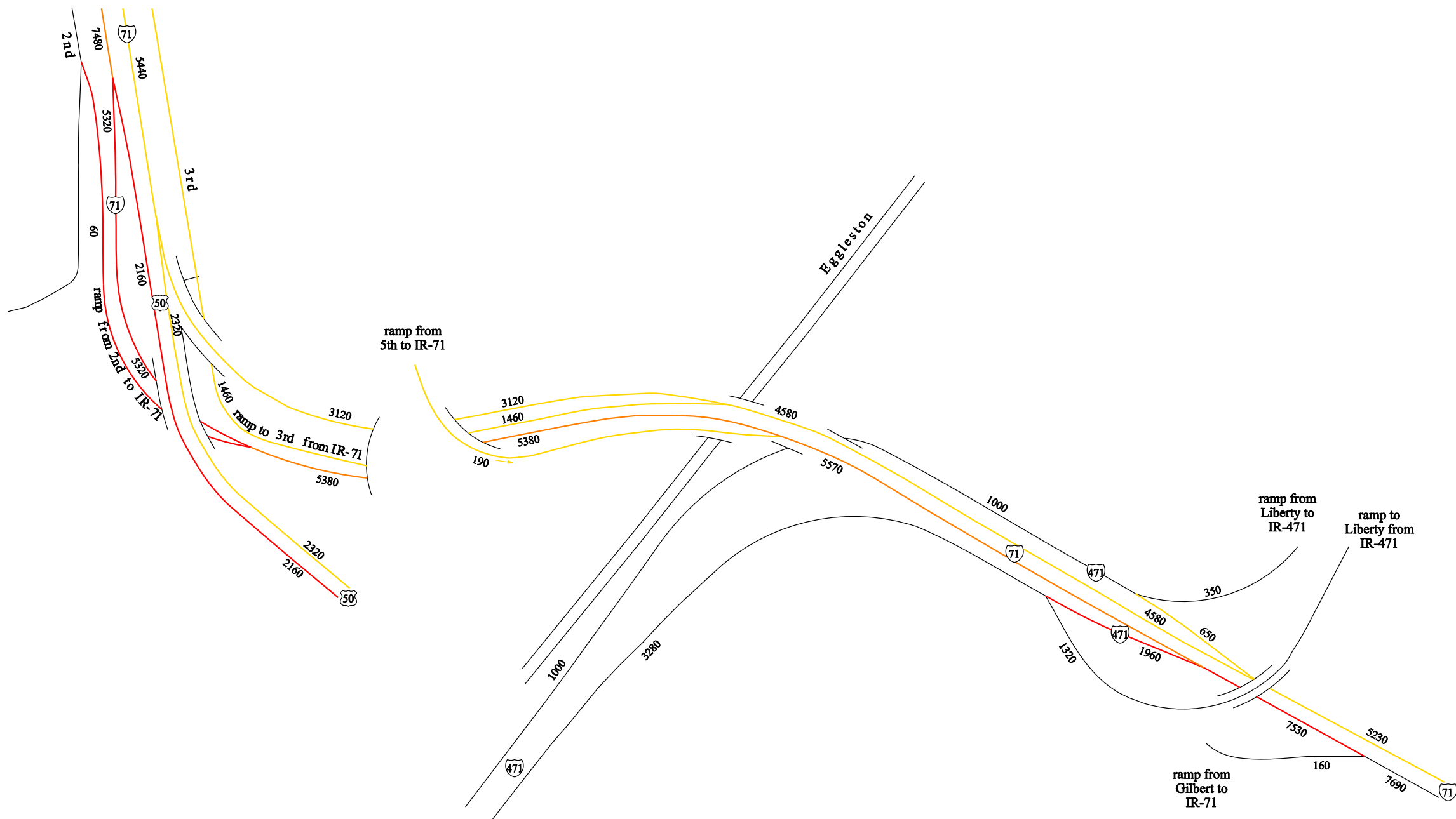

**LEGEND**

- Level of Service A
- Level of Service B
- Level of Service C
- Level of Service D
- Level of Service E
- Level of Service F
- 2569 # of Vehicles per Hour
- (12) Intersection ID #

NOT TO SCALE



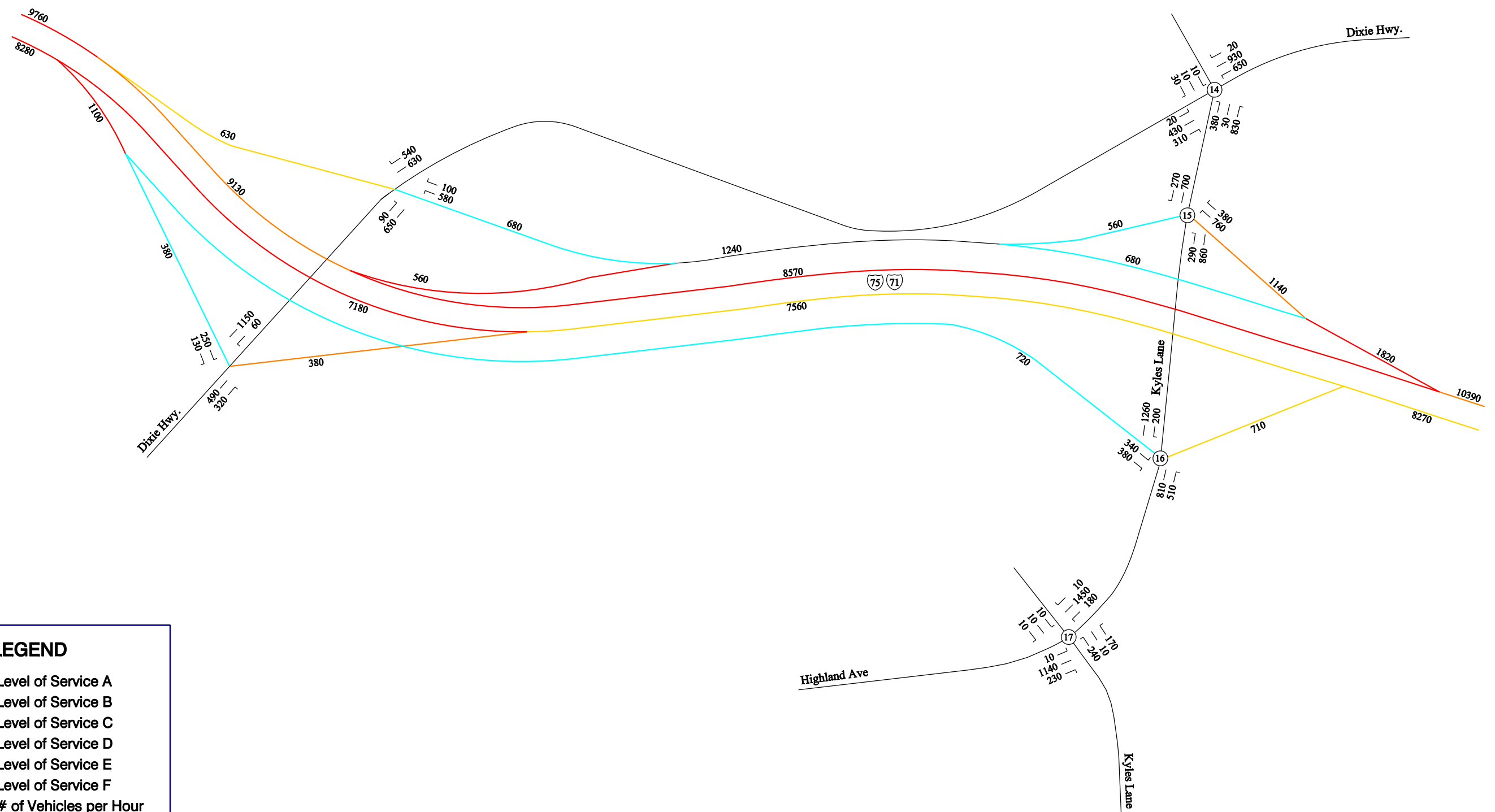

**LEGEND**

- Level of Service A
  - Level of Service B
  - Level of Service C
  - Level of Service D
  - Level of Service E
  - Level of Service F
- 2569 # of Vehicles per Hour
- (12) Intersection ID #

NOT TO SCALE



**2035 PM LEVEL OF SERVICE  
ALTERNATIVE C  
(KENTUCKY)**

SHEET  
(1 OF 9)

**EXHIBIT  
A6-A**



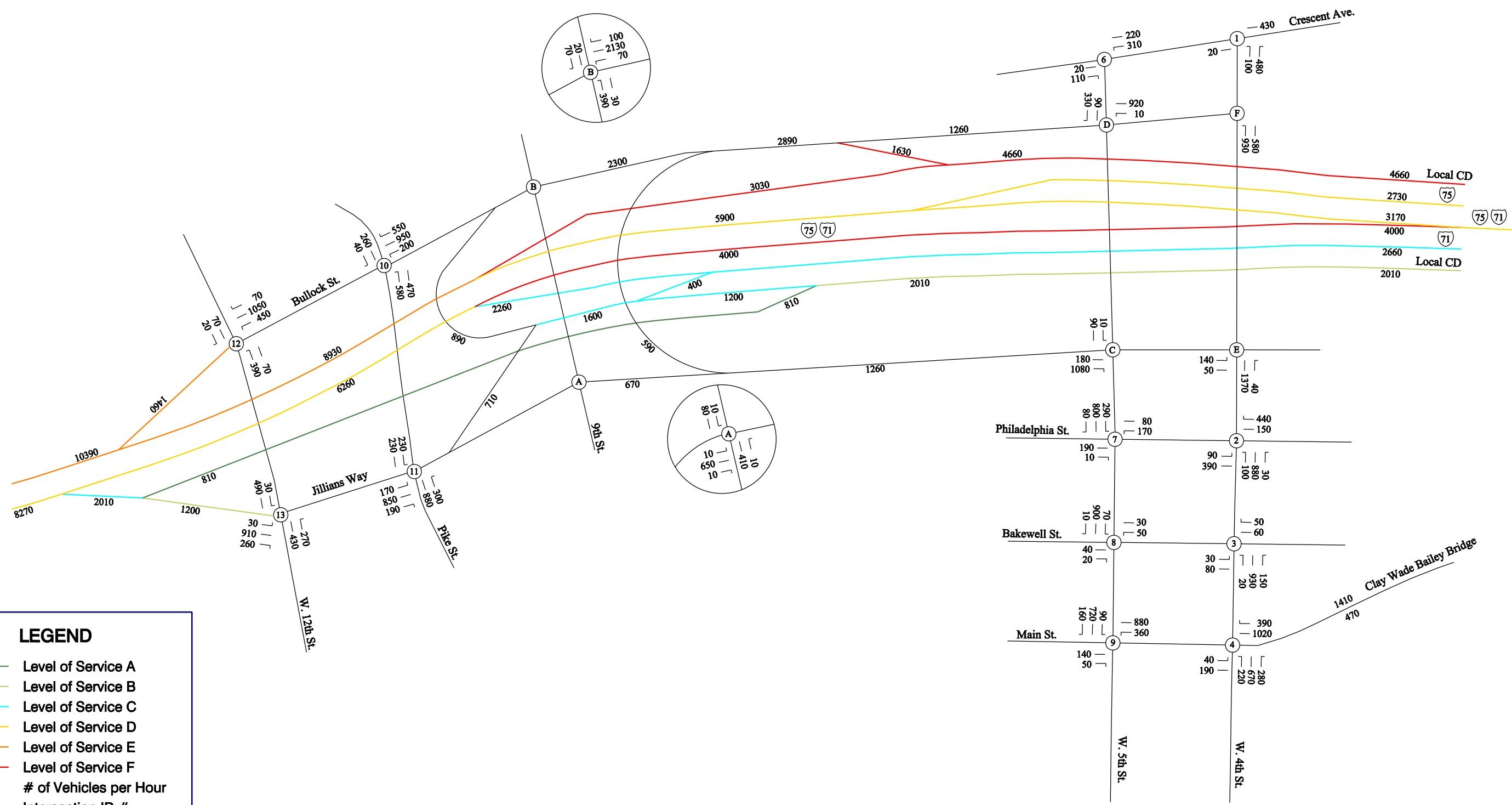

**LEGEND**

- Level of Service A
- Level of Service B
- Level of Service C
- Level of Service D
- Level of Service E
- Level of Service F
- 2569 # of Vehicles per Hour
- (12) Intersection ID #

NOT TO SCALE



**2035 PM LEVEL OF SERVICE  
ALTERNATIVE C  
(KENTUCKY)**

SHEET  
(2 OF 9)

**EXHIBIT  
A6-B**

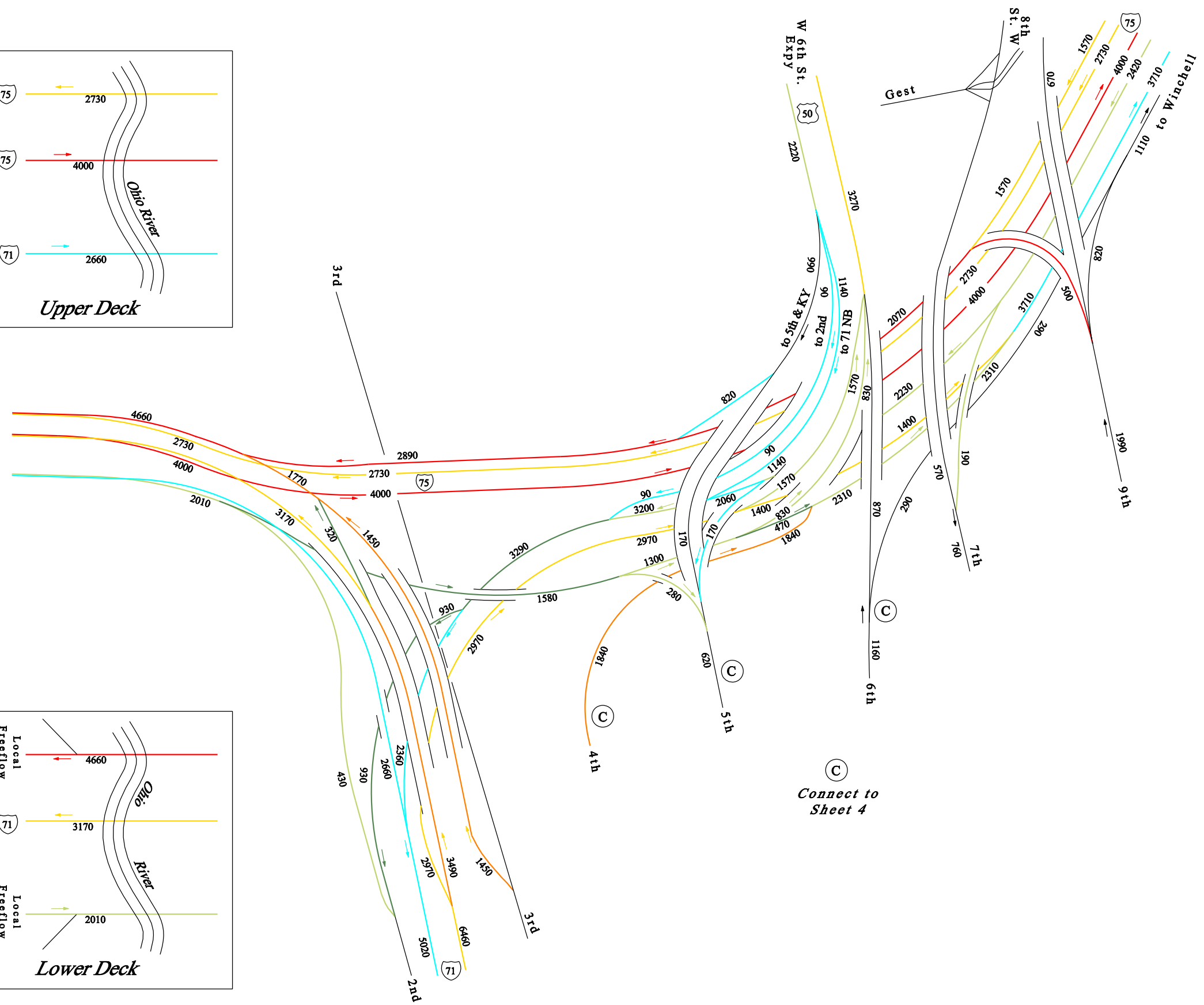
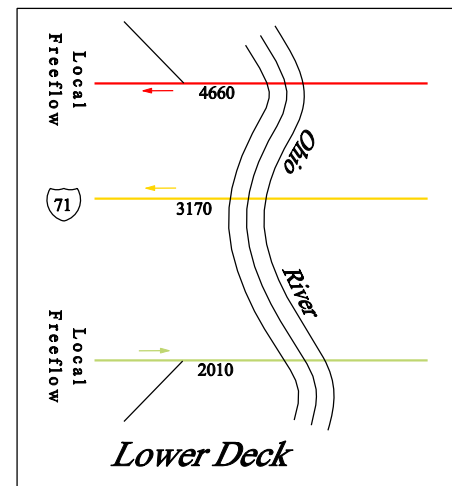
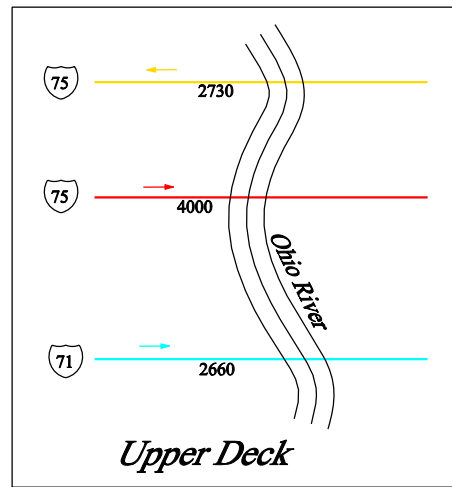

**LEGEND**

- Level of Service A
- Level of Service B
- Level of Service C
- Level of Service D
- Level of Service E
- Level of Service F

2569 # of Vehicles per Hour  
 (12) Intersection ID #

NOT TO SCALE

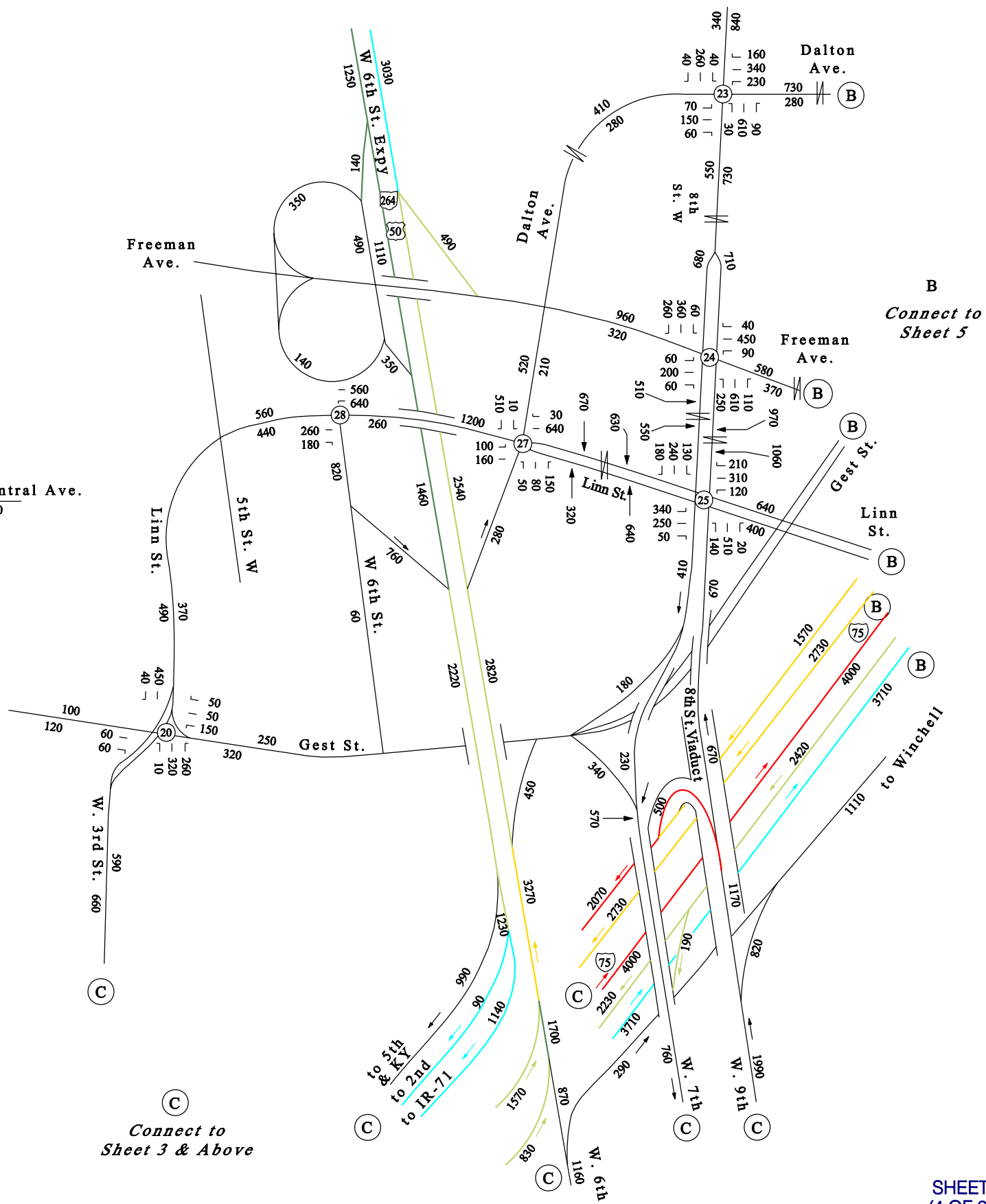
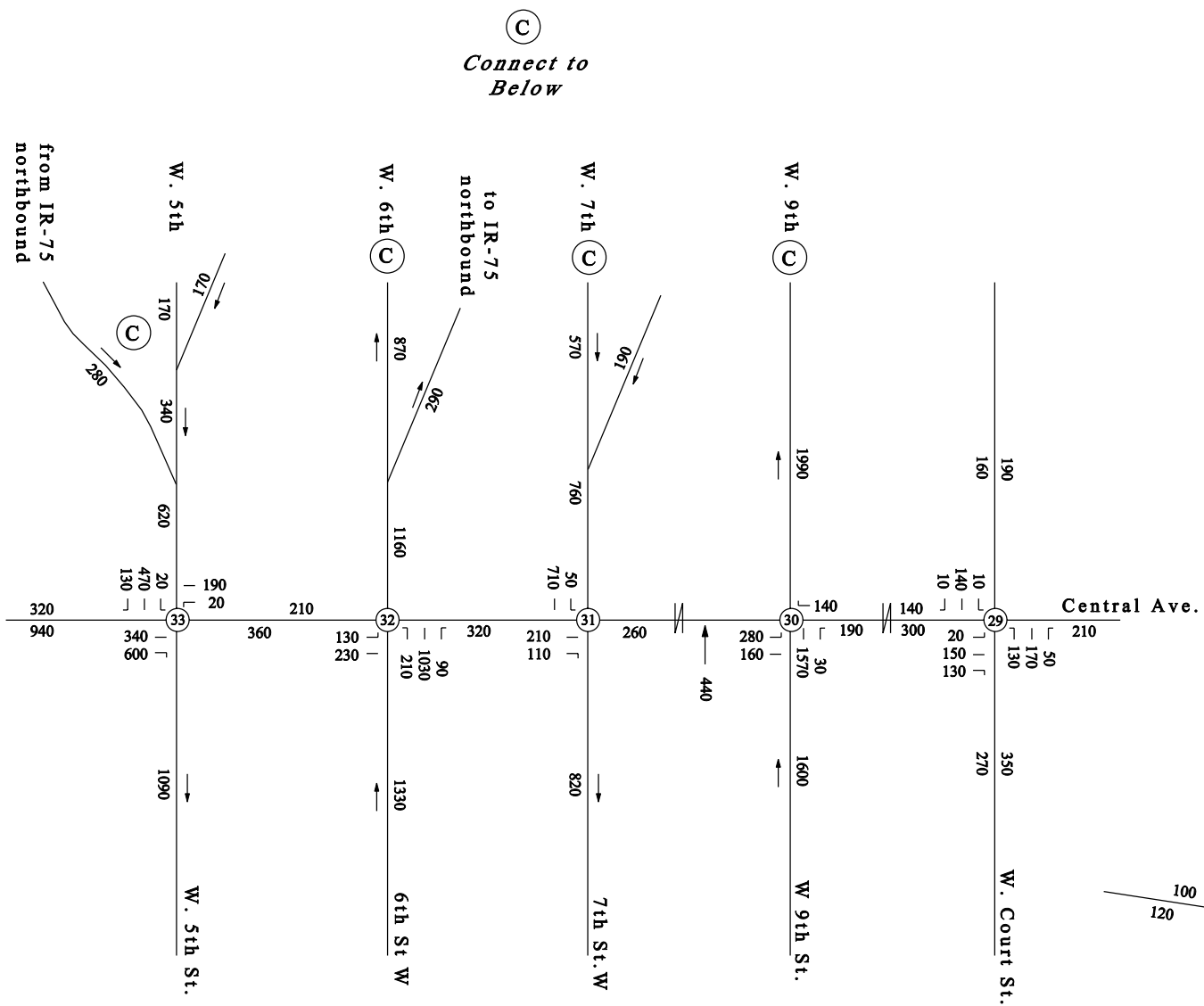

**LEGEND**

- Level of Service A
- Level of Service B
- Level of Service C
- Level of Service D
- Level of Service E
- Level of Service F
- 2569 # of Vehicles per Hour
- 12 Intersection ID #

NOT TO SCALE



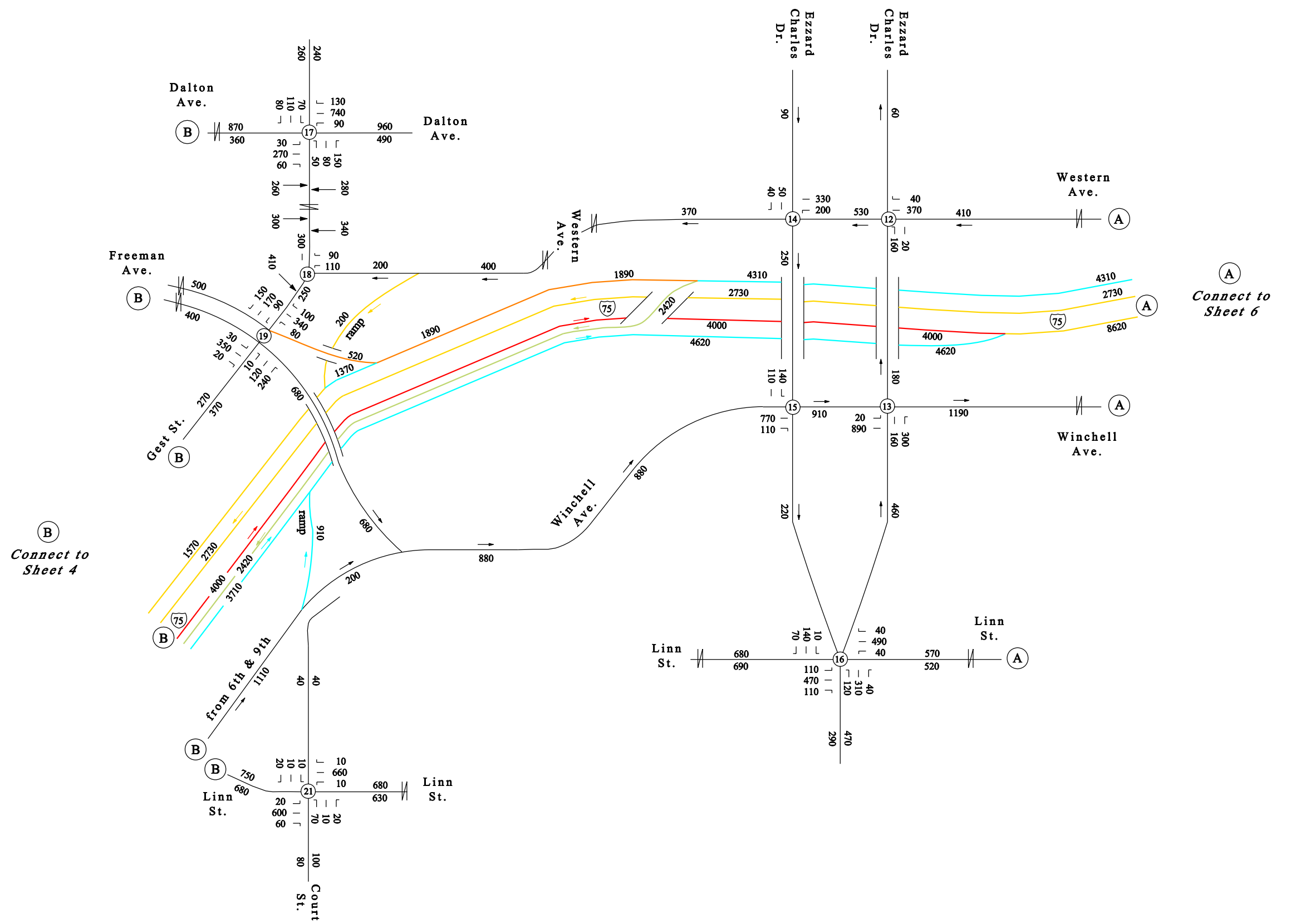

**LEGEND**

- Level of Service A
- Level of Service B
- Level of Service C
- Level of Service D
- Level of Service E
- Level of Service F
- 2569 # of Vehicles per Hour
- (12) Intersection ID #

NOT TO SCALE



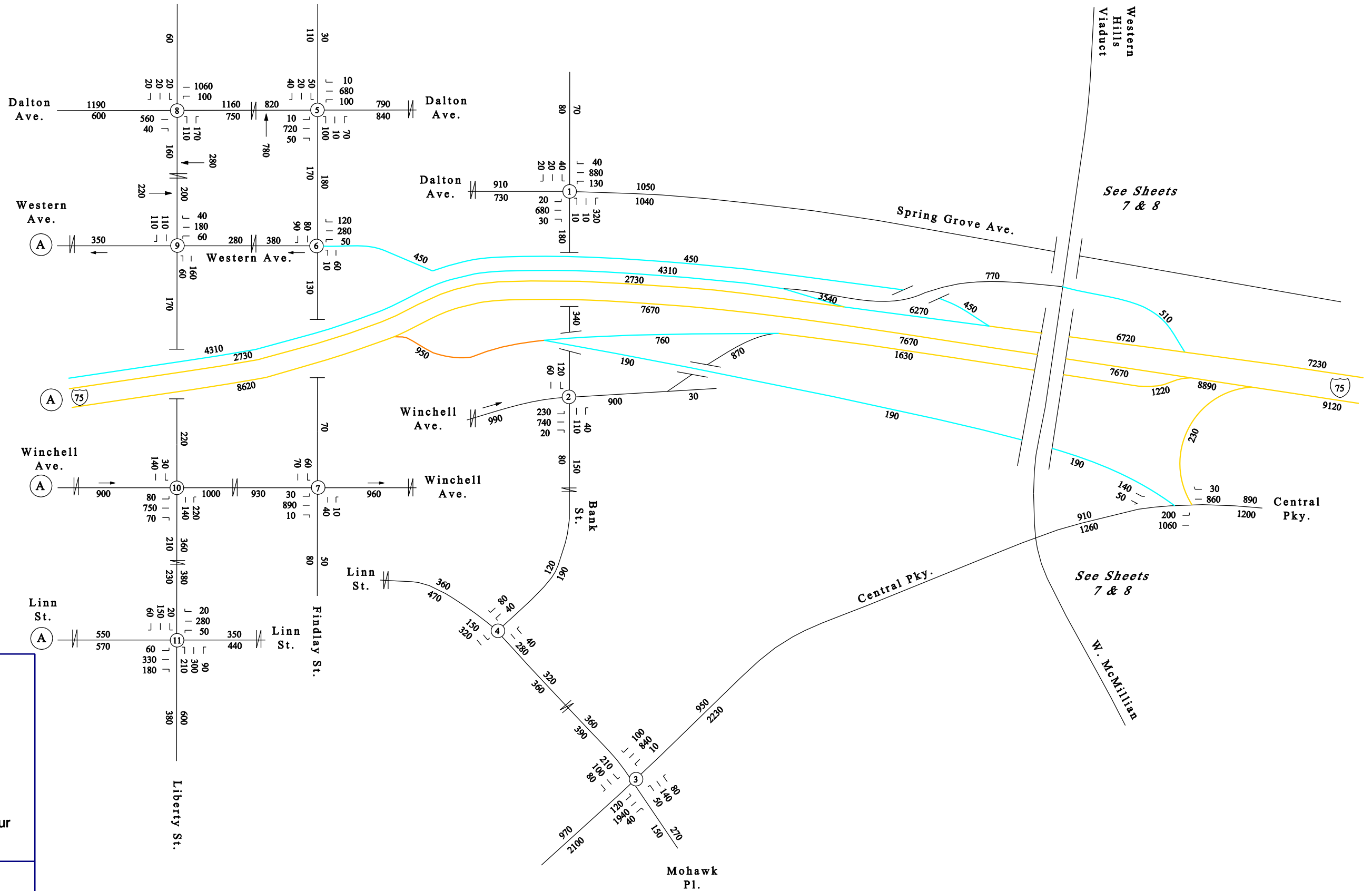

A  
Connect to  
Sheet 5

**LEGEND**

- Level of Service A
  - Level of Service B
  - Level of Service C
  - Level of Service D
  - Level of Service E
  - Level of Service F
- 2569 # of Vehicles per Hour  
 (12) Intersection ID #

NOT TO SCALE



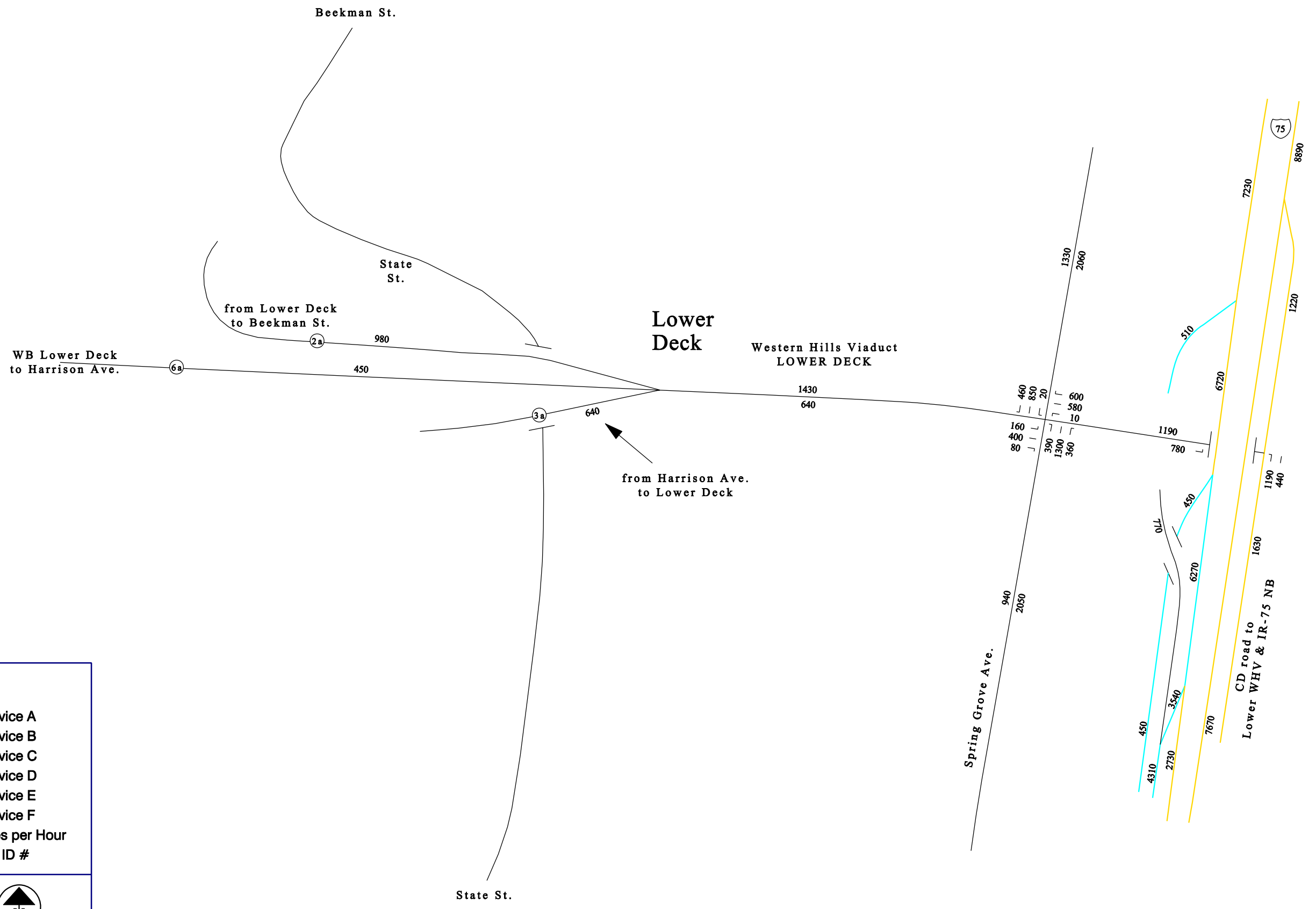

**LEGEND**

- Level of Service A
- Level of Service B
- Level of Service C
- Level of Service D
- Level of Service E
- Level of Service F
- 2569 # of Vehicles per Hour
- (12) Intersection ID #

NOT TO SCALE



**2035 PM LEVEL OF SERVICE  
ALTERNATIVE C  
(OHIO)**

SHEET  
(7 OF 9)

**EXHIBIT  
A6-G**

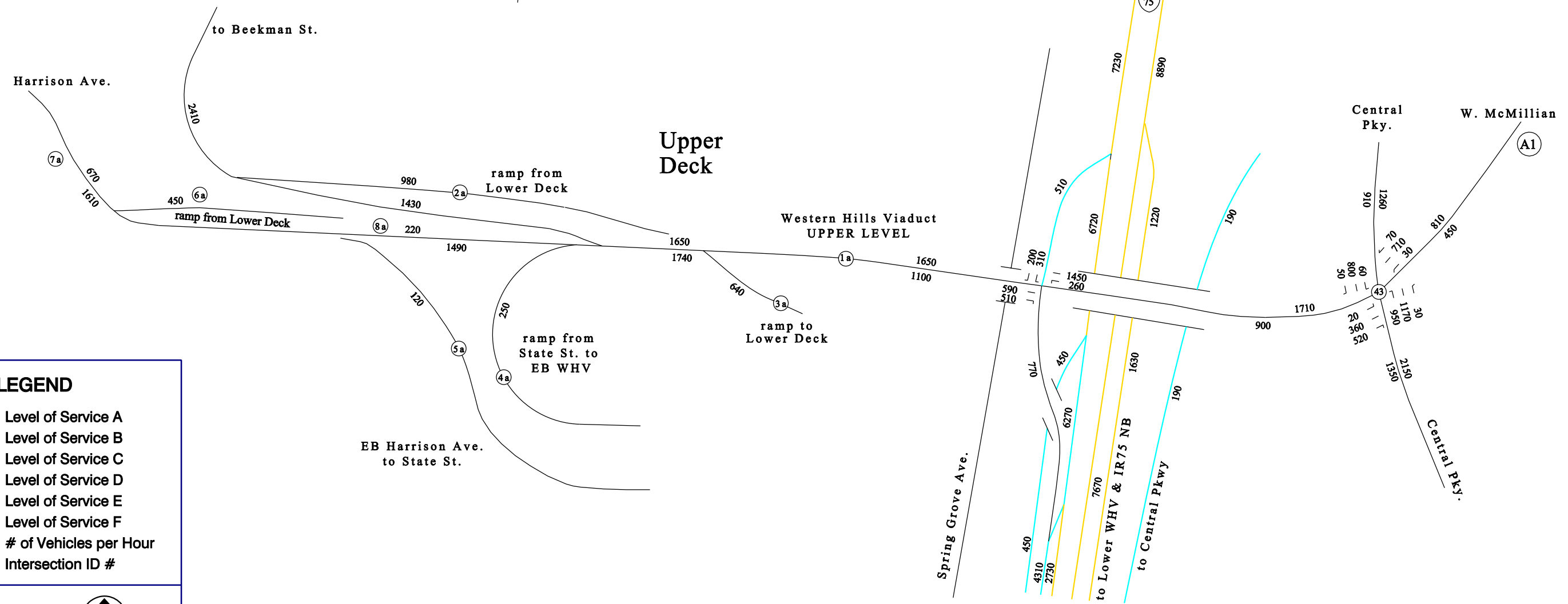
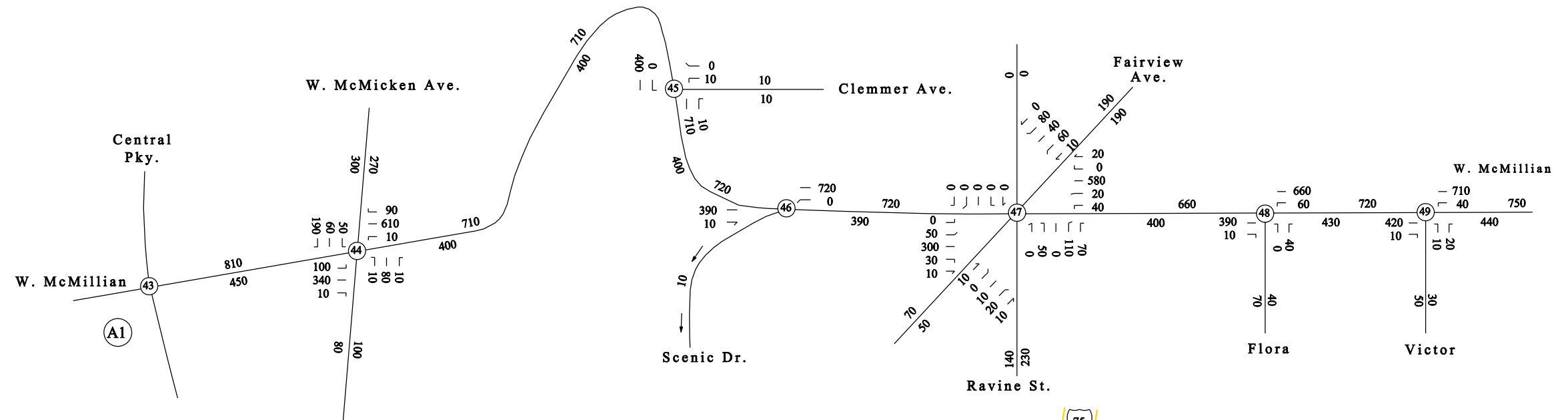

**LEGEND**

- Level of Service A
  - Level of Service B
  - Level of Service C
  - Level of Service D
  - Level of Service E
  - Level of Service F
- 2569 # of Vehicles per Hour
- (12) Intersection ID #

NOT TO SCALE



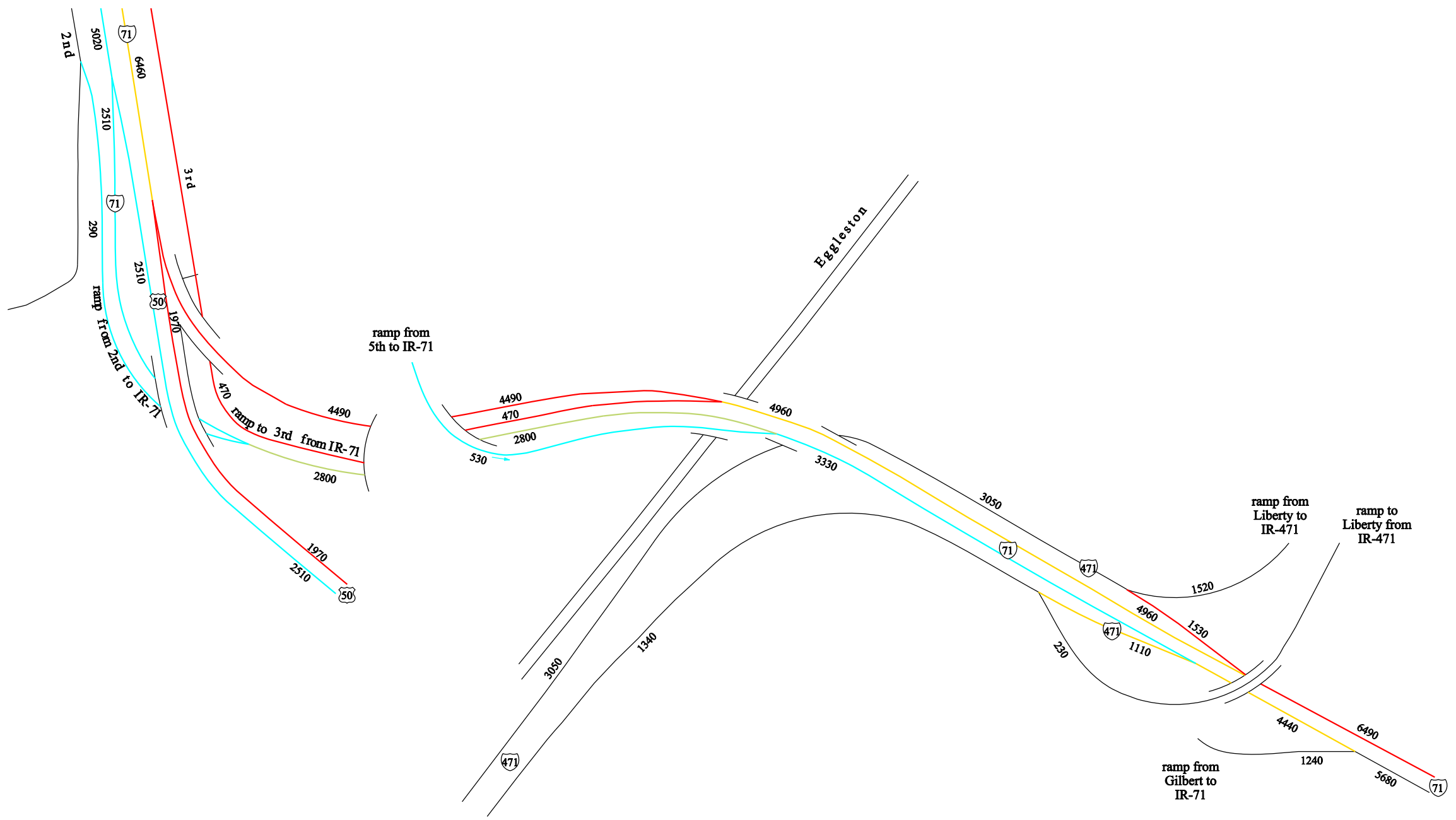

**LEGEND**

- Level of Service A
- Level of Service B
- Level of Service C
- Level of Service D
- Level of Service E
- Level of Service F
- 2569 # of Vehicles per Hour
- (12) Intersection ID #

NOT TO SCALE





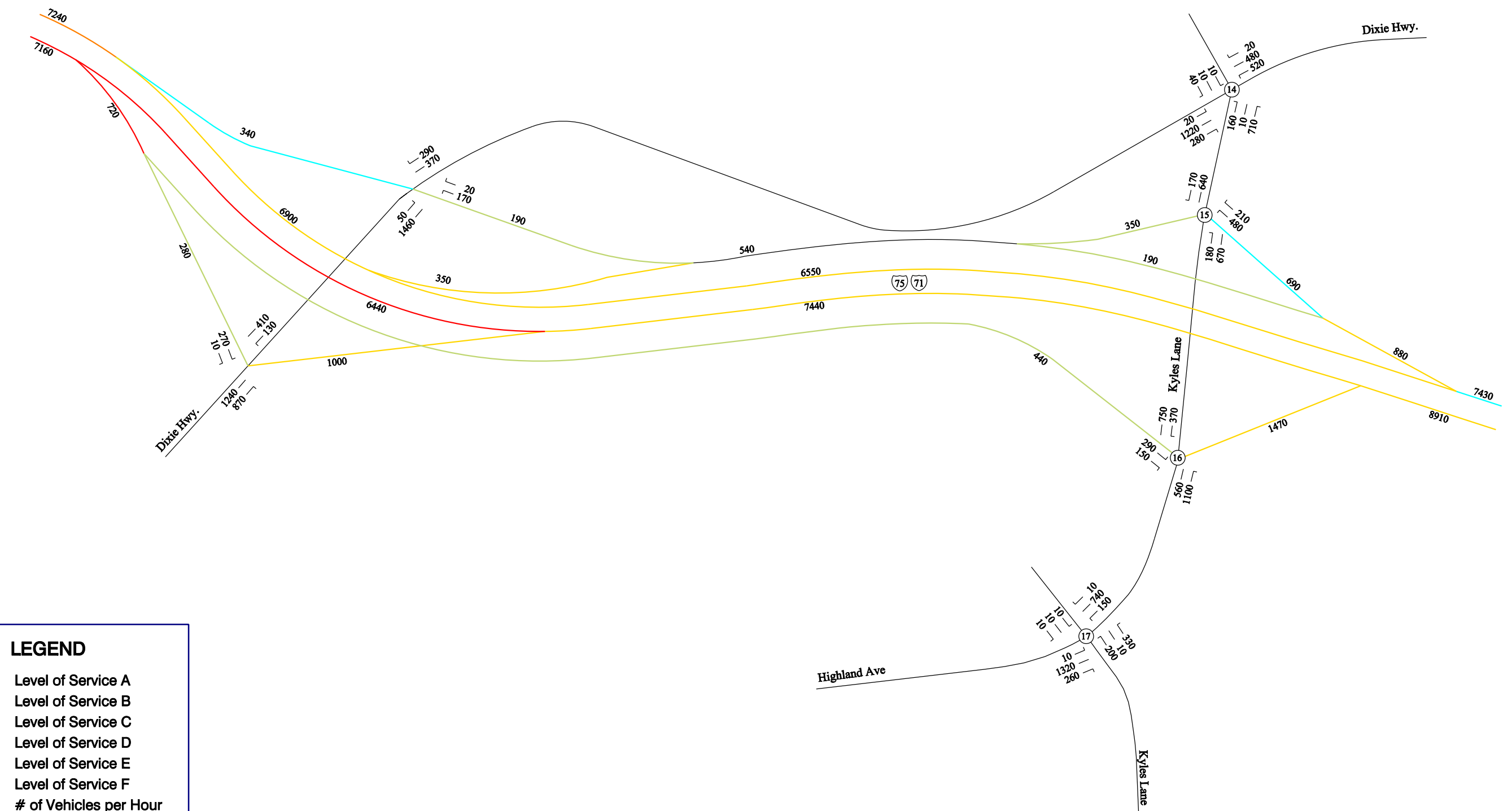

**LEGEND**

- Level of Service A
- Level of Service B
- Level of Service C
- Level of Service D
- Level of Service E
- Level of Service F
- 2569 # of Vehicles per Hour
- (12) Intersection ID #

NOT TO SCALE



**2035 AM LEVEL OF SERVICE  
ALTERNATIVE D  
(KENTUCKY)**

SHEET  
(1 OF 9)

**EXHIBIT  
A7-A**

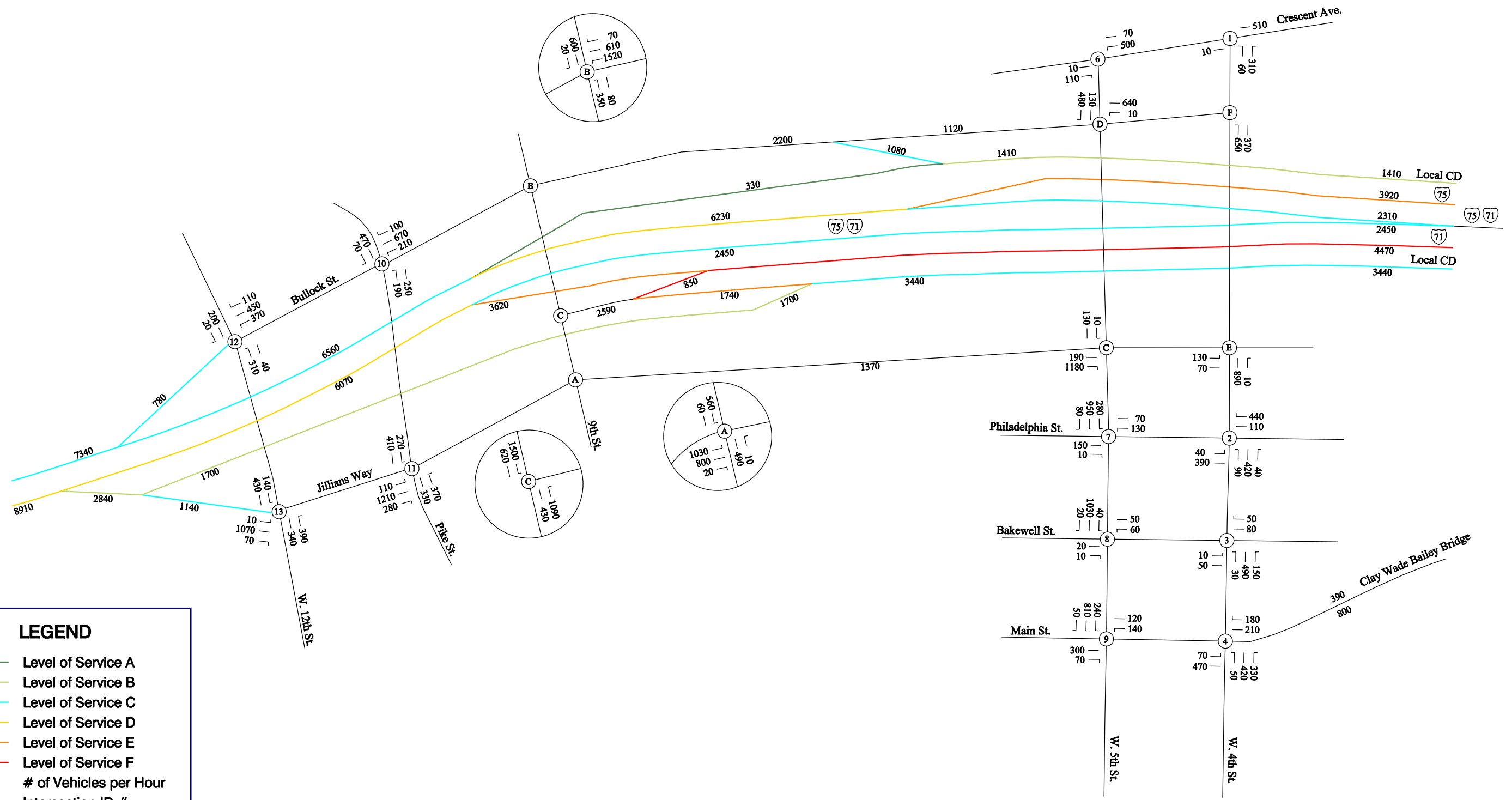

**LEGEND**

- Level of Service A
- Level of Service B
- Level of Service C
- Level of Service D
- Level of Service E
- Level of Service F
- 2569 # of Vehicles per Hour
- (12) Intersection ID #

NOT TO SCALE



**2035 AM LEVEL OF SERVICE  
ALTERNATIVE D  
(KENTUCKY)**

SHEET  
(2 OF 9)

**EXHIBIT  
A7-B**

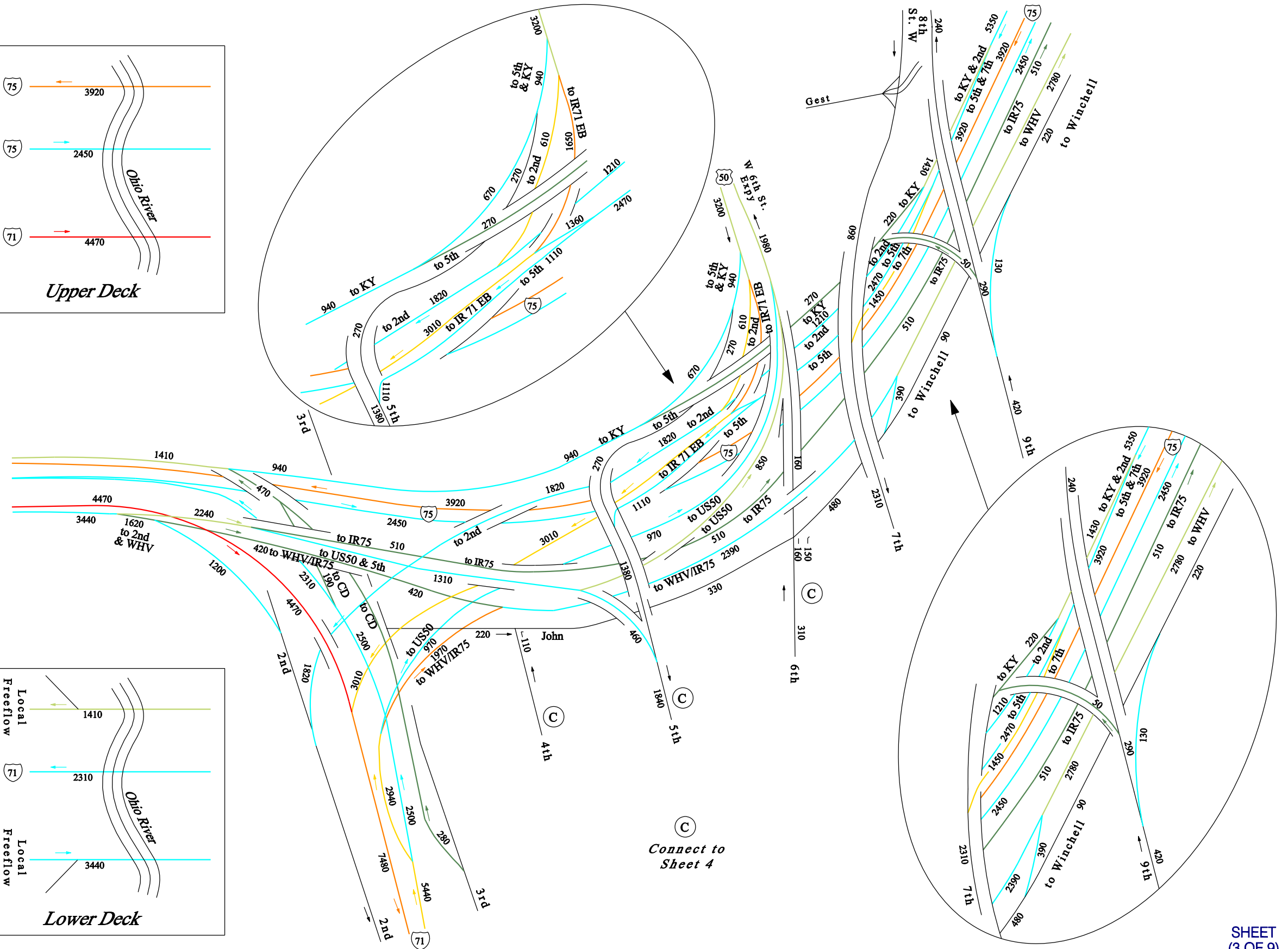
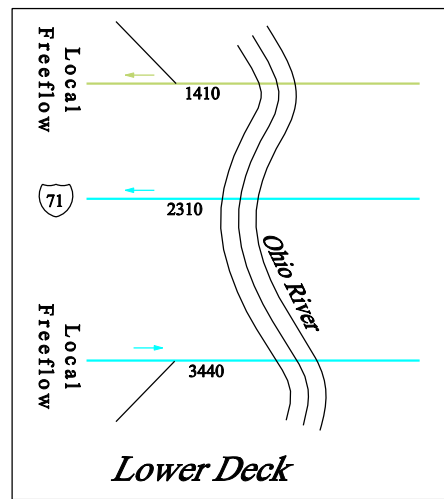
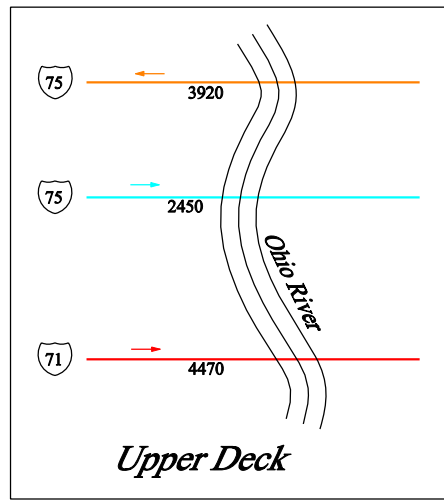

Connect to Sheet 4

**LEGEND**

- Level of Service A
- Level of Service B
- Level of Service C
- Level of Service D
- Level of Service E
- Level of Service F

2569 # of Vehicles per Hour  
 (12) Intersection ID #

NOT TO SCALE

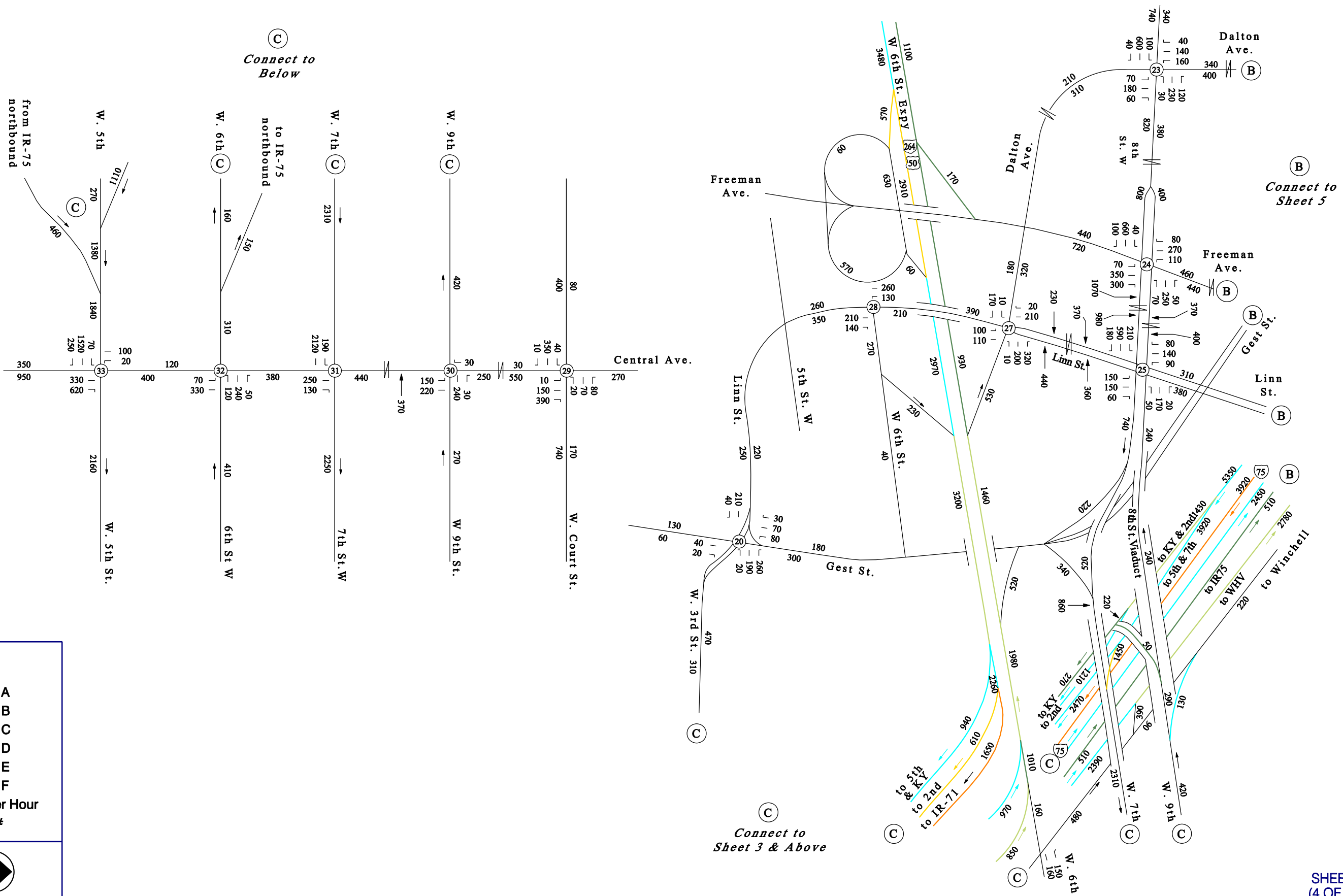

**LEGEND**

- Level of Service A
- Level of Service B
- Level of Service C
- Level of Service D
- Level of Service E
- Level of Service F
- 2569 # of Vehicles per Hour
- 12 Intersection ID #

NOT TO SCALE

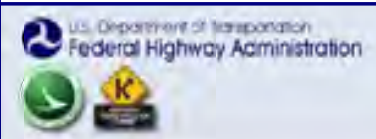

**2035 AM LEVEL OF SERVICE  
ALTERNATIVE D  
(OHIO)**

SHEET  
(4 OF 9)

**EXHIBIT  
A7-D**

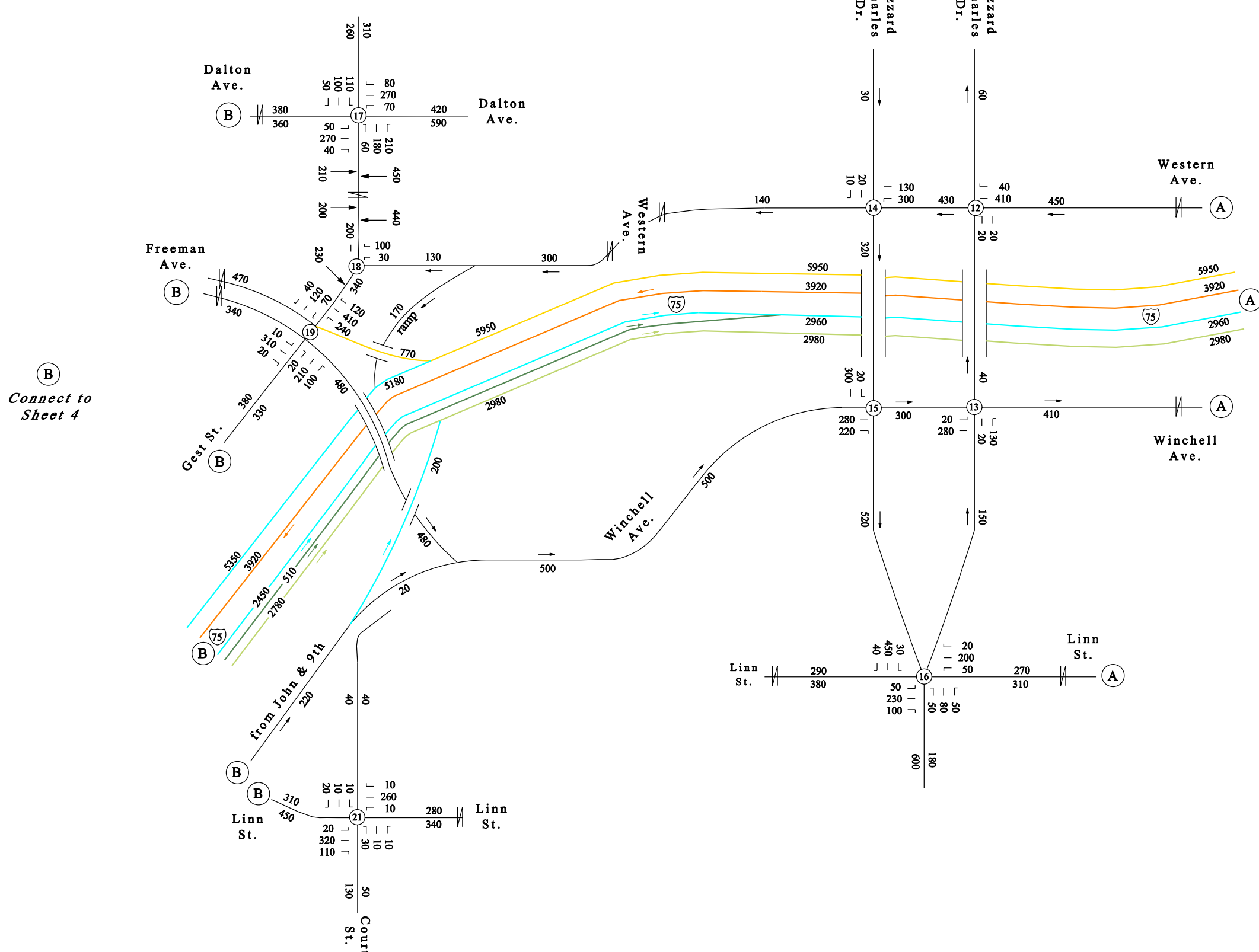

(B) Connect to Sheet 4

(A) Connect to Sheet 6

**LEGEND**

- Level of Service A
- Level of Service B
- Level of Service C
- Level of Service D
- Level of Service E
- Level of Service F
- 2569 # of Vehicles per Hour
- (12) Intersection ID #

NOT TO SCALE



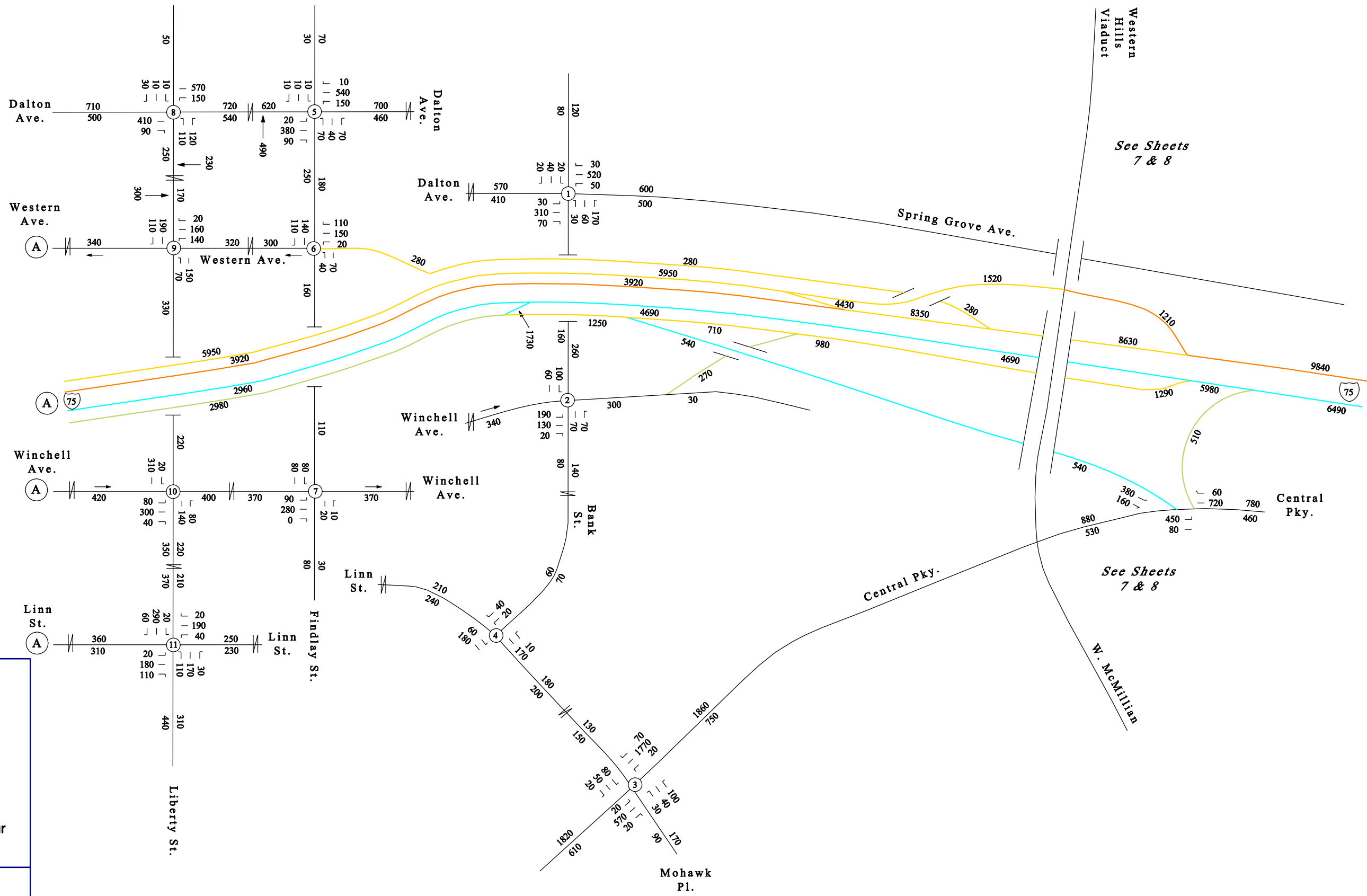

See Sheets  
7 & 8

See Sheets  
7 & 8

A  
Connect to  
Sheet 5

**LEGEND**

- Level of Service A
- Level of Service B
- Level of Service C
- Level of Service D
- Level of Service E
- Level of Service F
- 2569 # of Vehicles per Hour
- (12) Intersection ID #

NOT TO SCALE

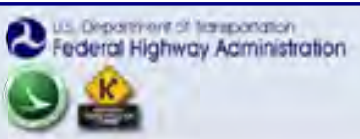

**2035 AM LEVEL OF SERVICE  
ALTERNATIVE D  
(OHIO)**

SHEET  
(6 OF 9)

**EXHIBIT  
A7-F**

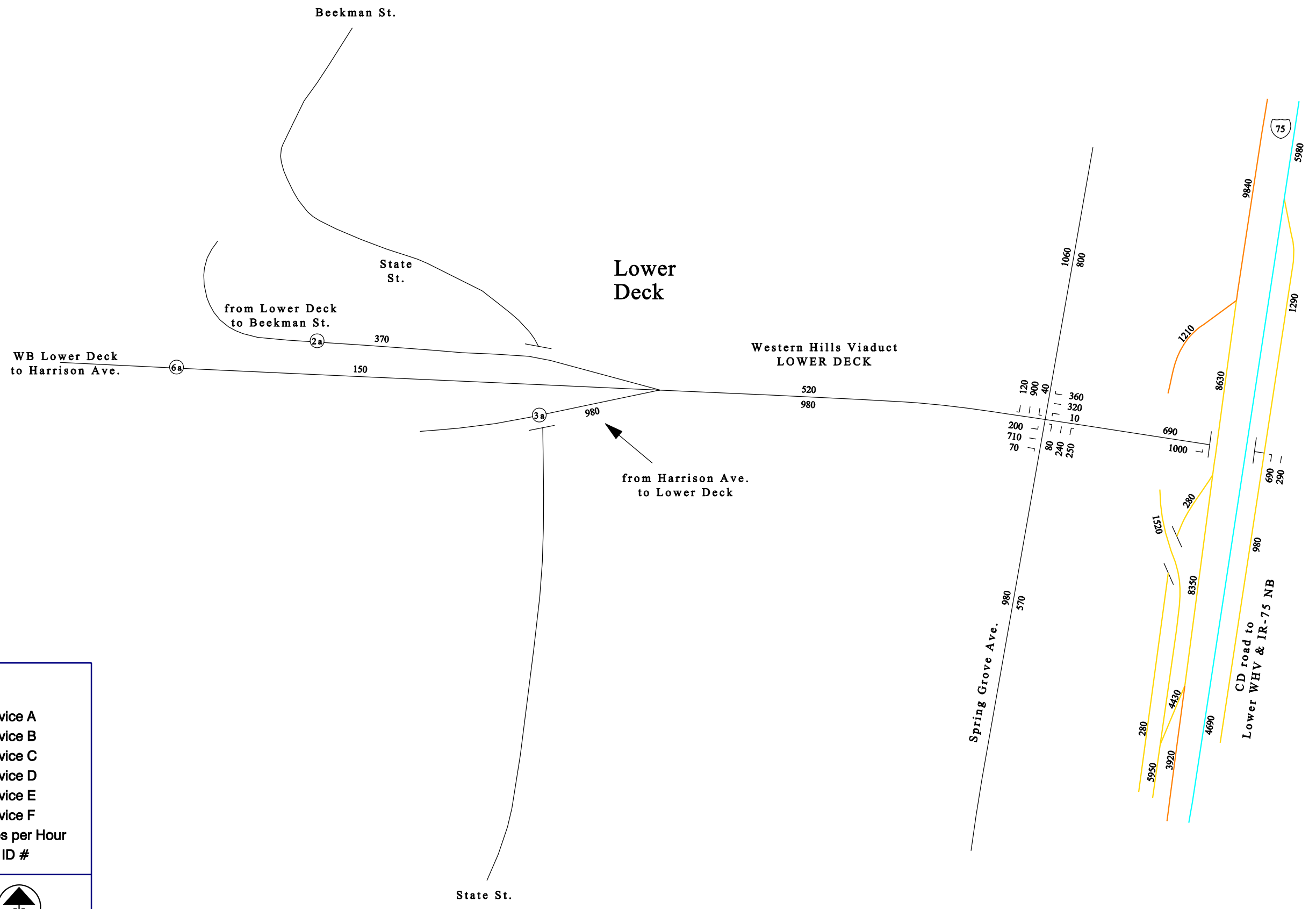

**LEGEND**

- Level of Service A
- Level of Service B
- Level of Service C
- Level of Service D
- Level of Service E
- Level of Service F
- 2569 # of Vehicles per Hour
- 12 Intersection ID #

NOT TO SCALE



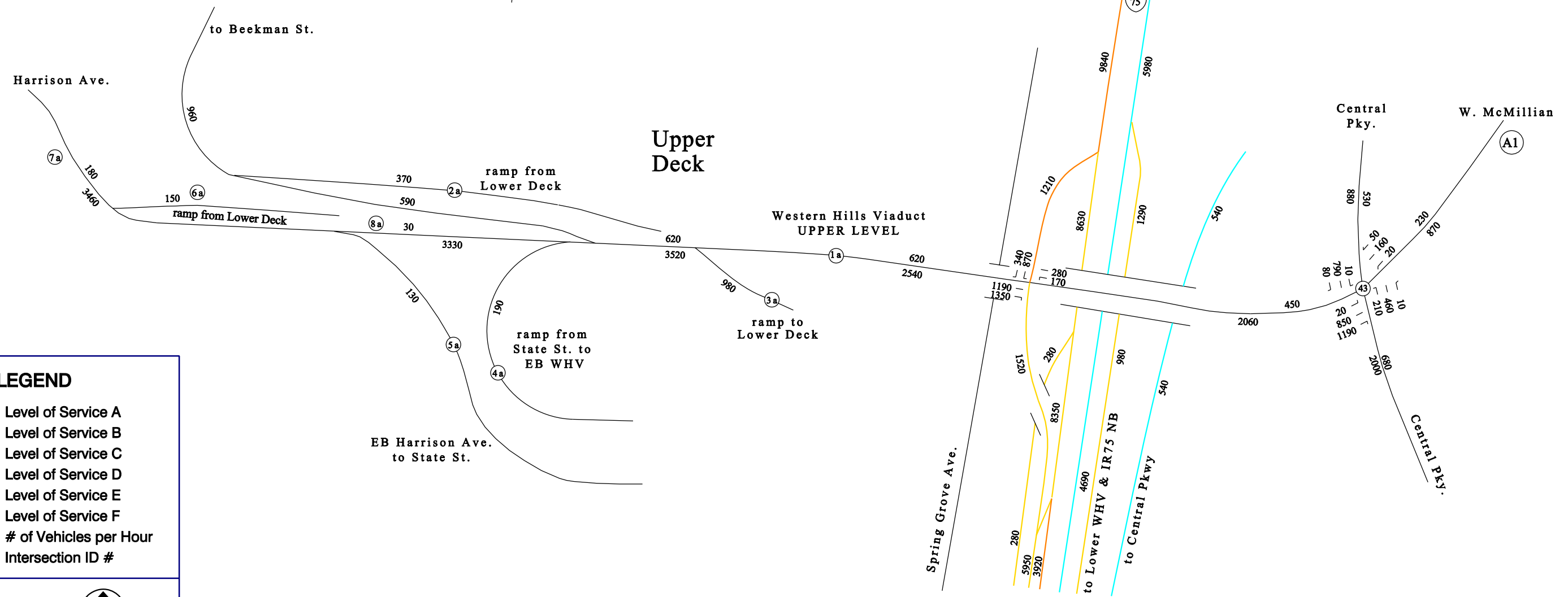
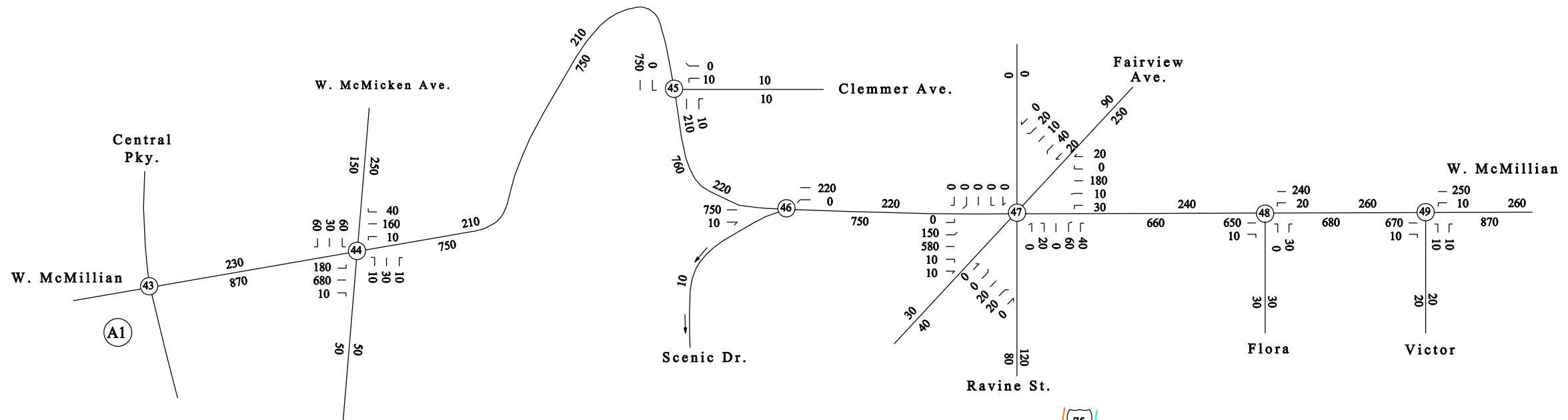

**LEGEND**

- Level of Service A
- Level of Service B
- Level of Service C
- Level of Service D
- Level of Service E
- Level of Service F
- 2569 # of Vehicles per Hour
- (12) Intersection ID #

NOT TO SCALE



**2035 AM LEVEL OF SERVICE  
ALTERNATIVE D  
(OHIO)**

SHEET  
(8 OF 9)

**EXHIBIT  
A7-H**

Prepared by:  
**PARSONS  
BRINCKERHOFF**



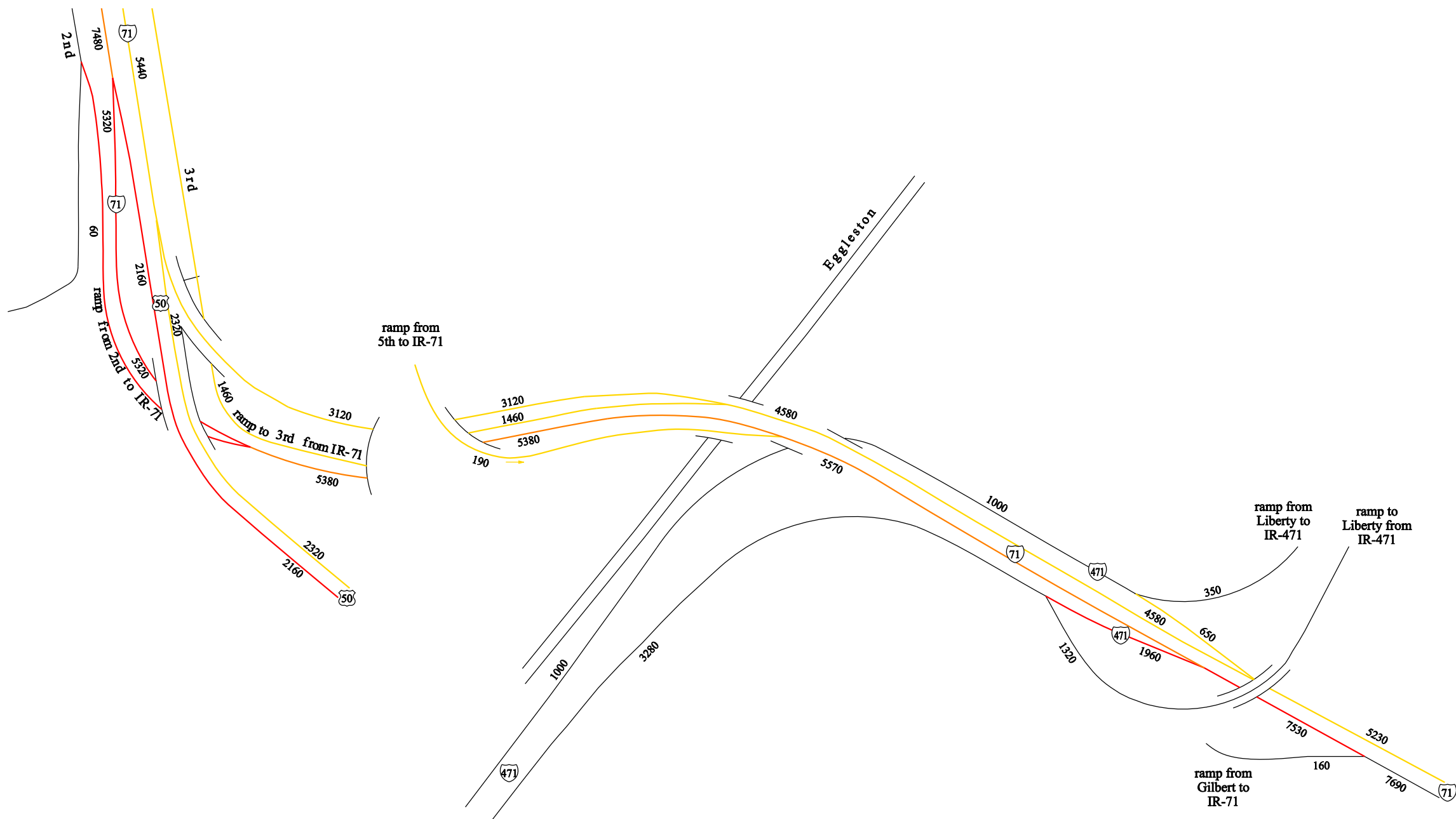

**LEGEND**

- Level of Service A
- Level of Service B
- Level of Service C
- Level of Service D
- Level of Service E
- Level of Service F
- 2569 # of Vehicles per Hour
- (12) Intersection ID #

NOT TO SCALE



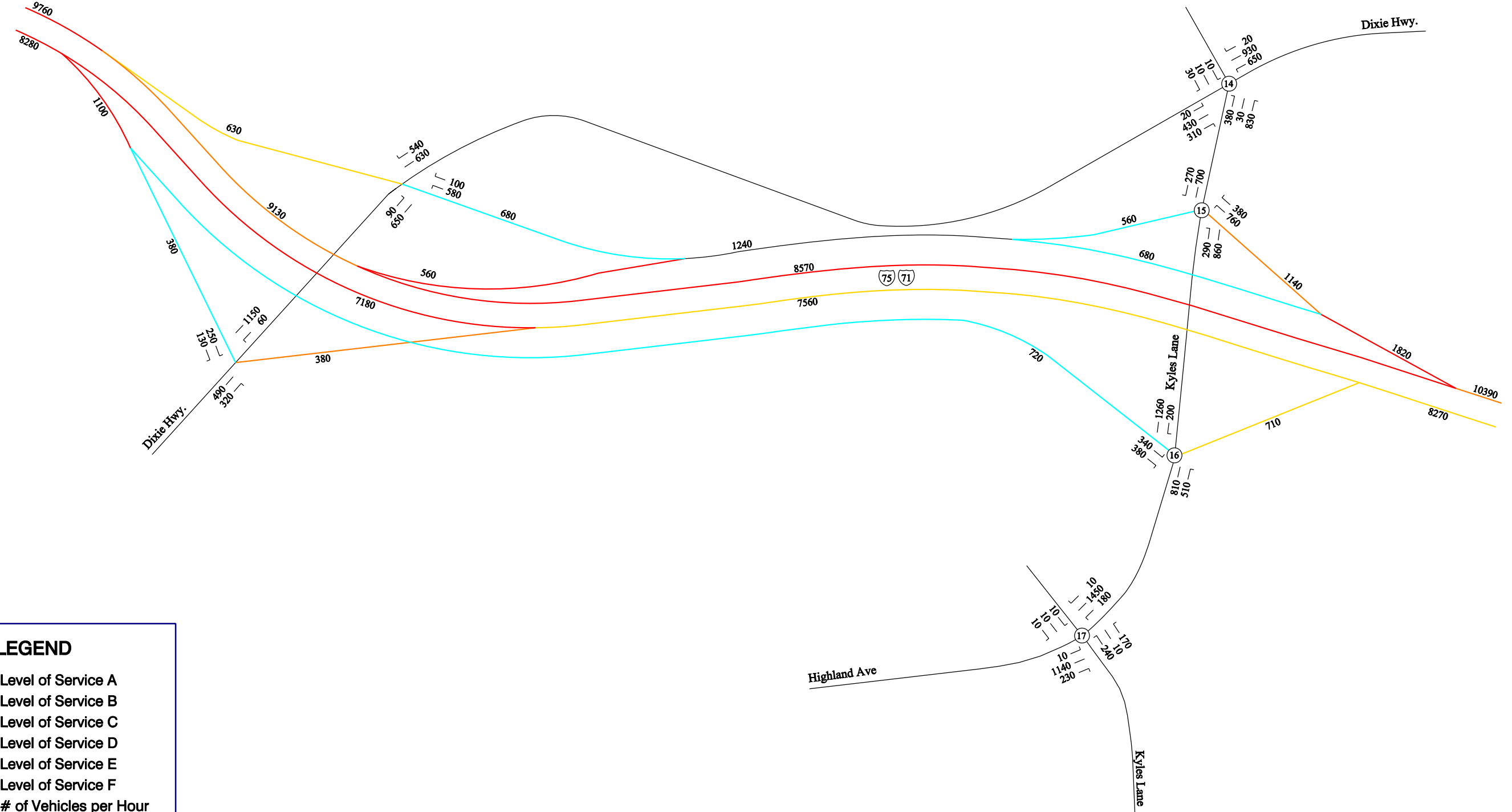

**LEGEND**

- Level of Service A
- Level of Service B
- Level of Service C
- Level of Service D
- Level of Service E
- Level of Service F
- 2569 # of Vehicles per Hour
- (12) Intersection ID #

NOT TO SCALE



**2035 PM LEVEL OF SERVICE  
ALTERNATIVE D  
(KENTUCKY)**

SHEET  
(1 OF 9)

**EXHIBIT  
A8-A**

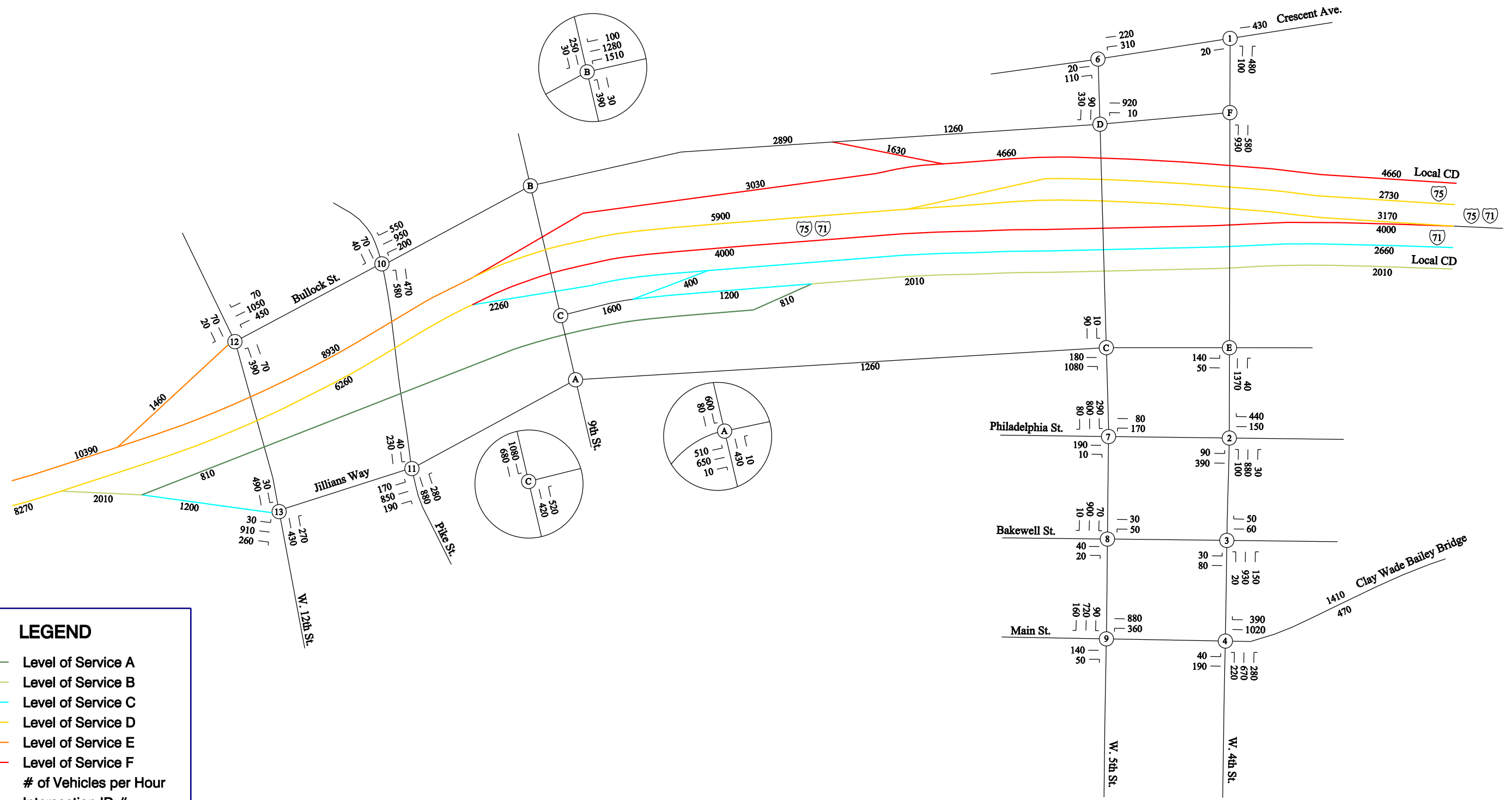

**LEGEND**

- Level of Service A
- Level of Service B
- Level of Service C
- Level of Service D
- Level of Service E
- Level of Service F
- 2569 # of Vehicles per Hour
- (12) Intersection ID #

NOT TO SCALE



**2035 PM LEVEL OF SERVICE  
ALTERNATIVE D  
(KENTUCKY)**

SHEET  
(2 OF 9)

**EXHIBIT  
A8-B**

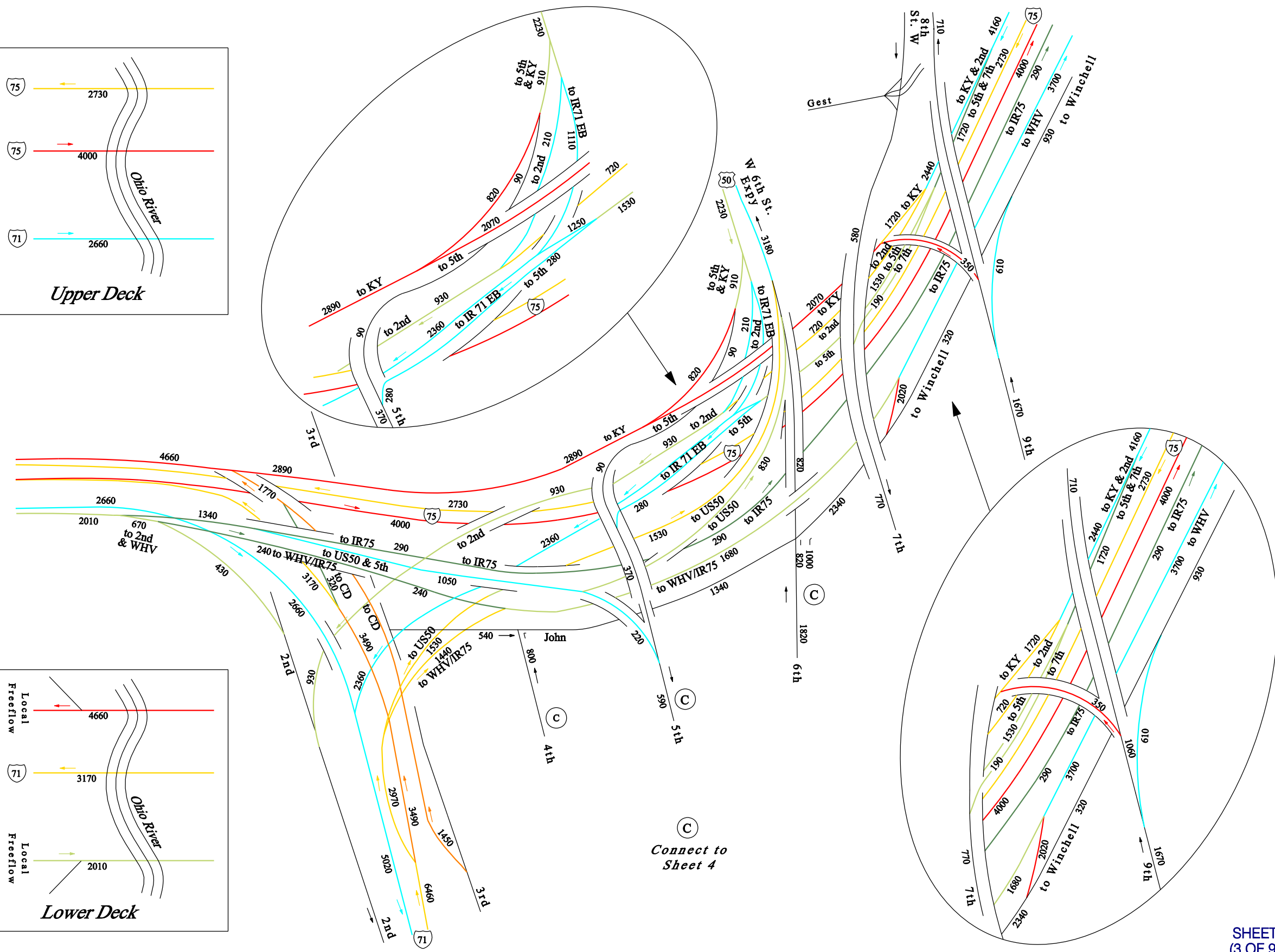
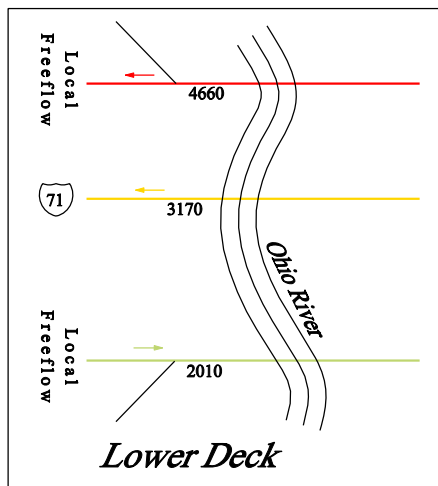
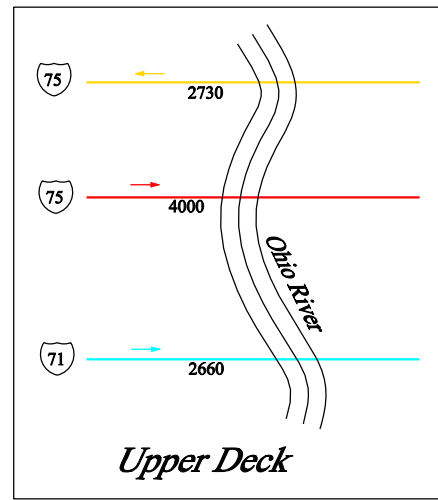

**LEGEND**

- Level of Service A
  - Level of Service B
  - Level of Service C
  - Level of Service D
  - Level of Service E
  - Level of Service F
- 2569 # of Vehicles per Hour  
 (12) Intersection ID #

NOT TO SCALE



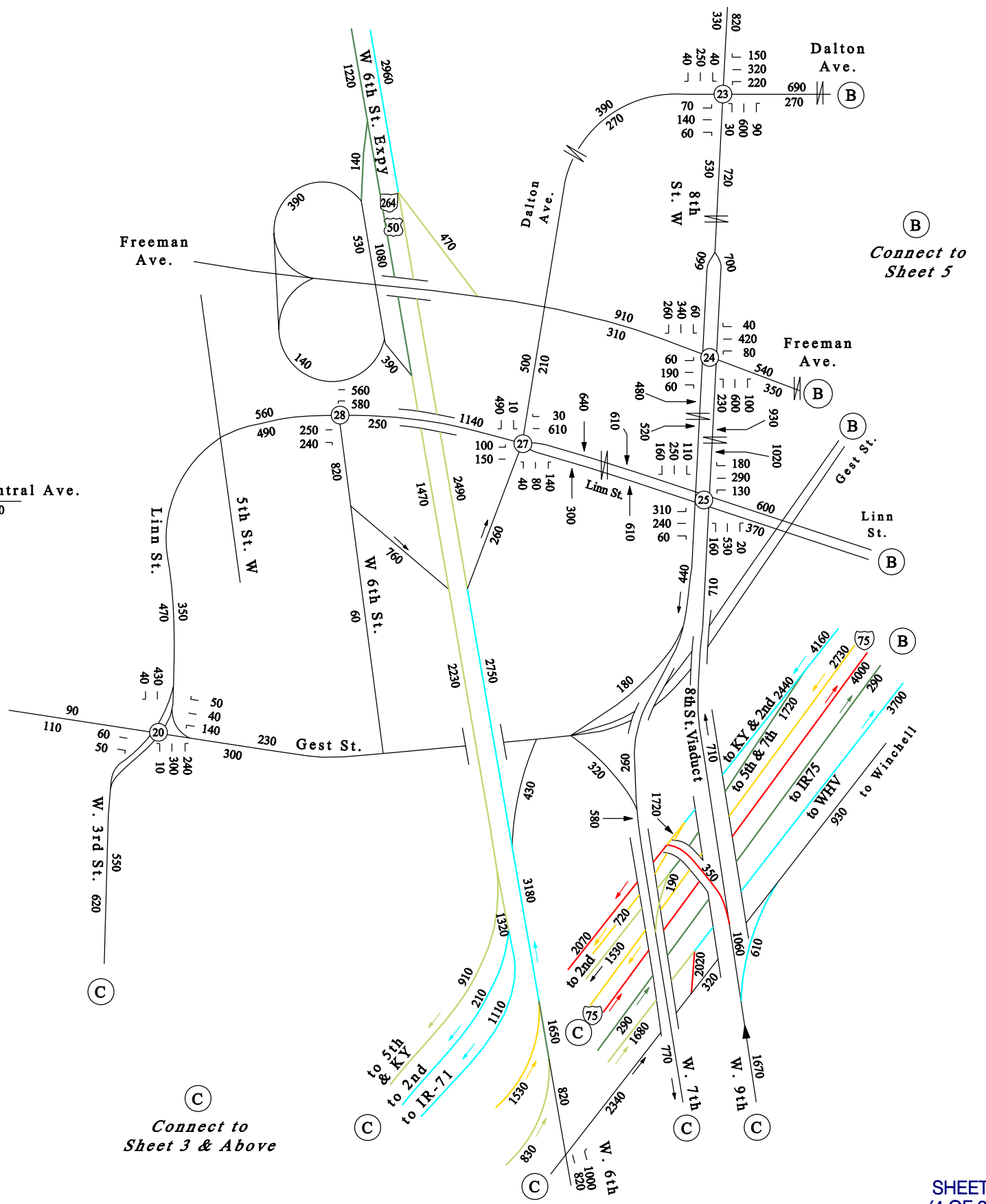
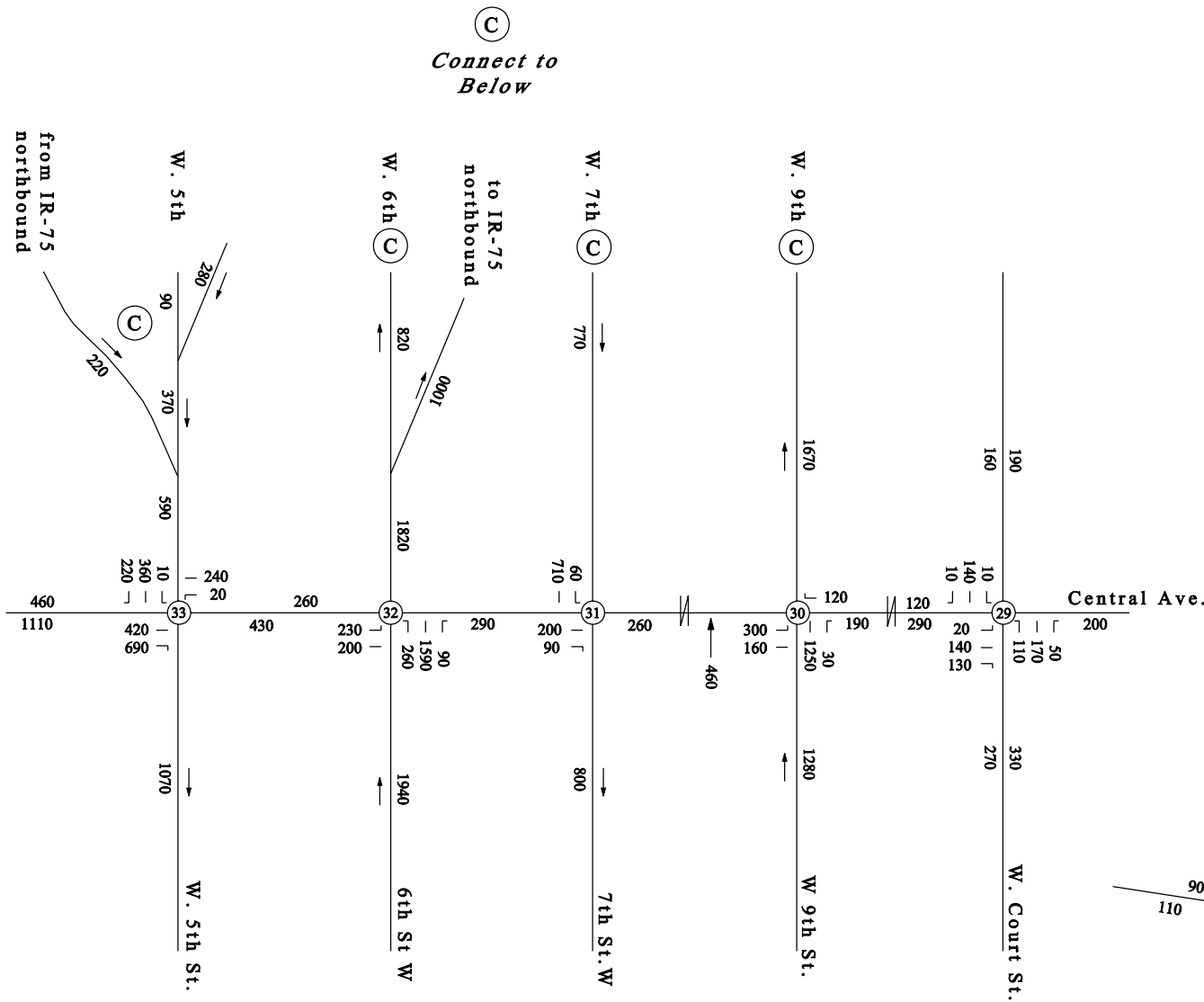

**LEGEND**

- Level of Service A
- Level of Service B
- Level of Service C
- Level of Service D
- Level of Service E
- Level of Service F
- 2569 # of Vehicles per Hour
- ⑫ Intersection ID #

NOT TO SCALE



(B)  
Connect to  
Sheet 4

(A)  
Connect to  
Sheet 6

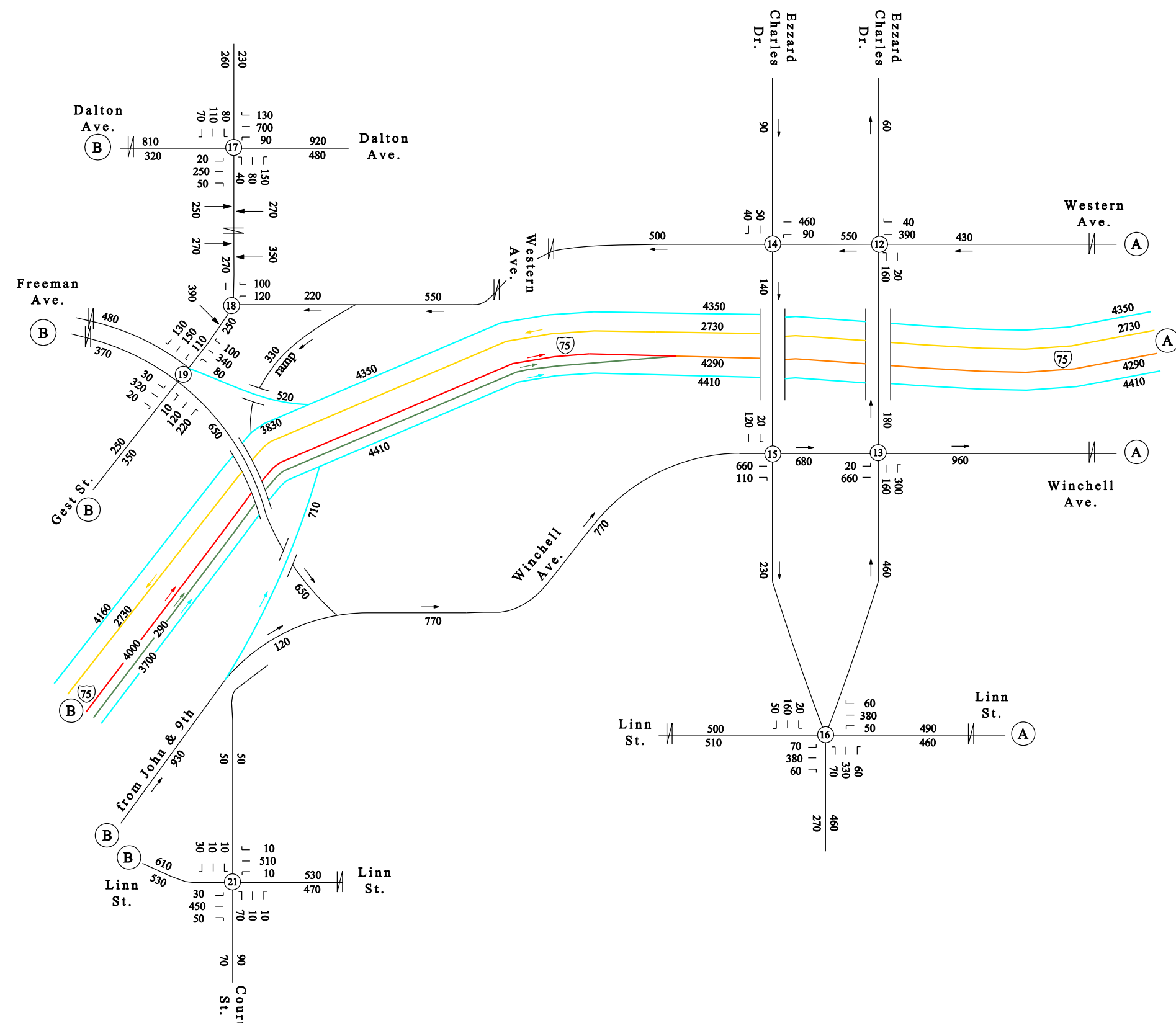

**LEGEND**

- Level of Service A
- Level of Service B
- Level of Service C
- Level of Service D
- Level of Service E
- Level of Service F
- 2569 # of Vehicles per Hour
- (12) Intersection ID #

NOT TO SCALE



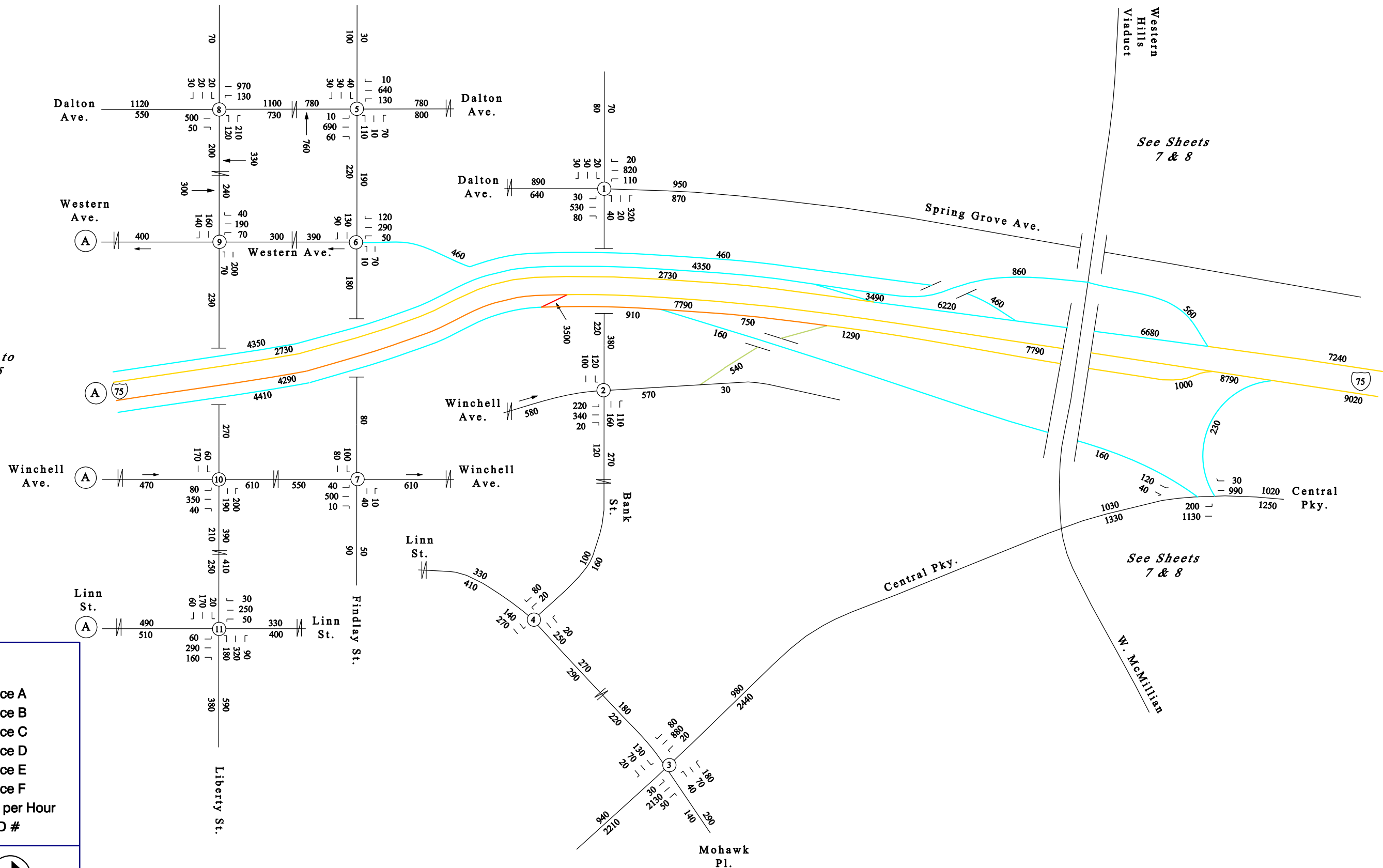

Ⓐ Connect to Sheet 5

See Sheets 7 & 8

See Sheets 7 & 8

**LEGEND**

- Level of Service A
- Level of Service B
- Level of Service C
- Level of Service D
- Level of Service E
- Level of Service F
- 2569 # of Vehicles per Hour
- Ⓐ Intersection ID #

NOT TO SCALE

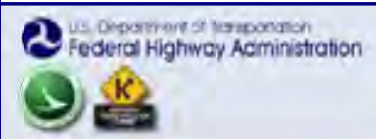

**2035 PM LEVEL OF SERVICE  
ALTERNATIVE D  
(OHIO)**

SHEET  
(6 OF 9)

**EXHIBIT  
A8-F**

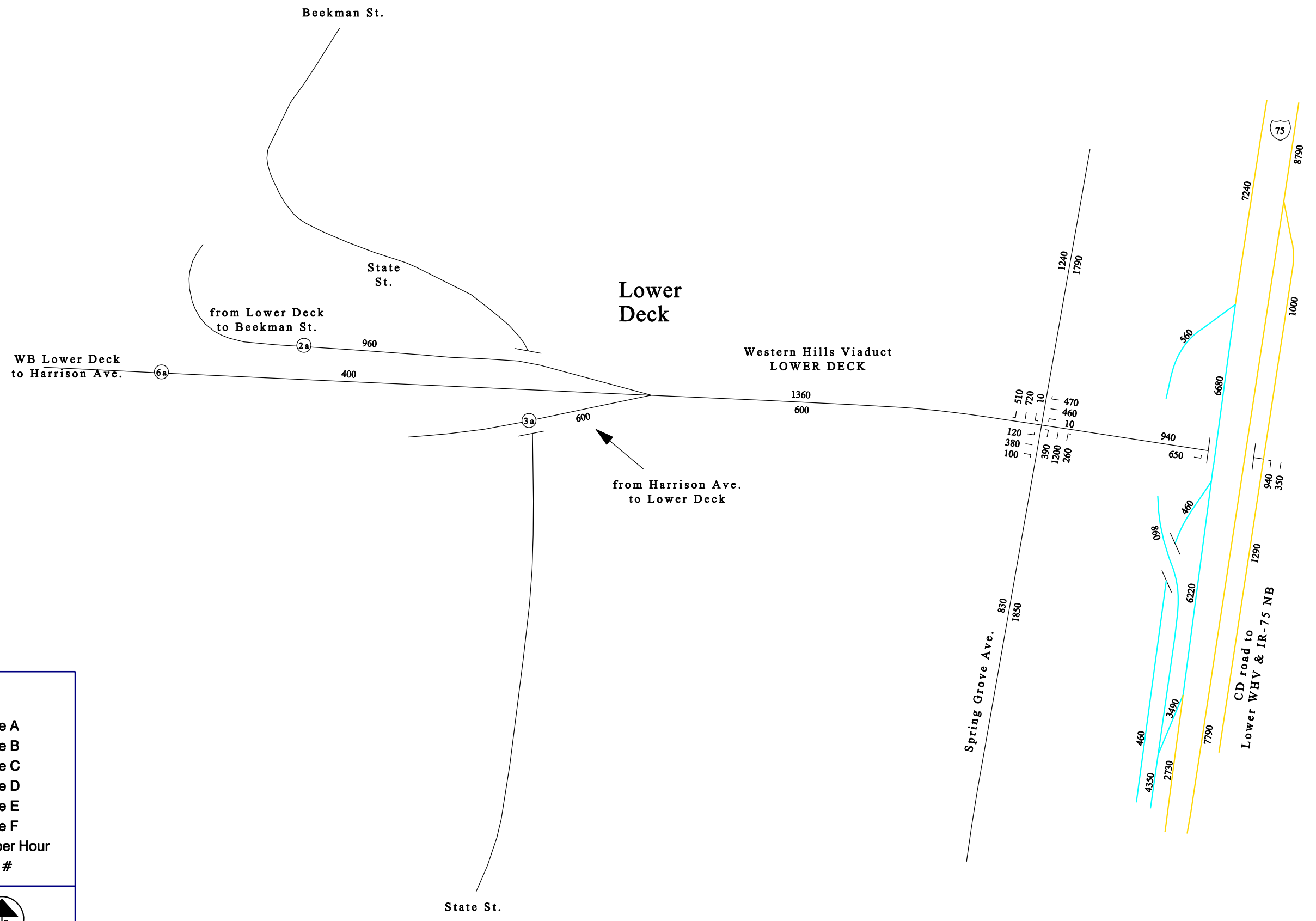

**LEGEND**

- Level of Service A
  - Level of Service B
  - Level of Service C
  - Level of Service D
  - Level of Service E
  - Level of Service F
- 2569 # of Vehicles per Hour
- (12) Intersection ID #

NOT TO SCALE





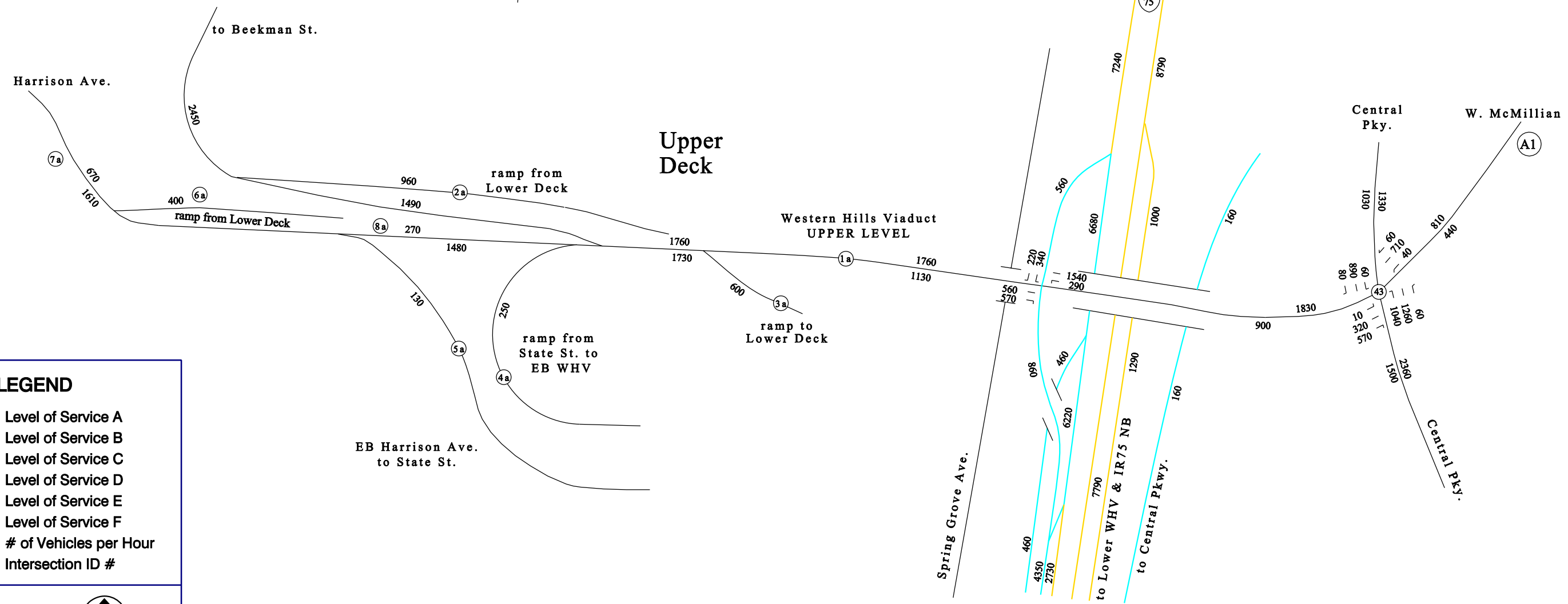
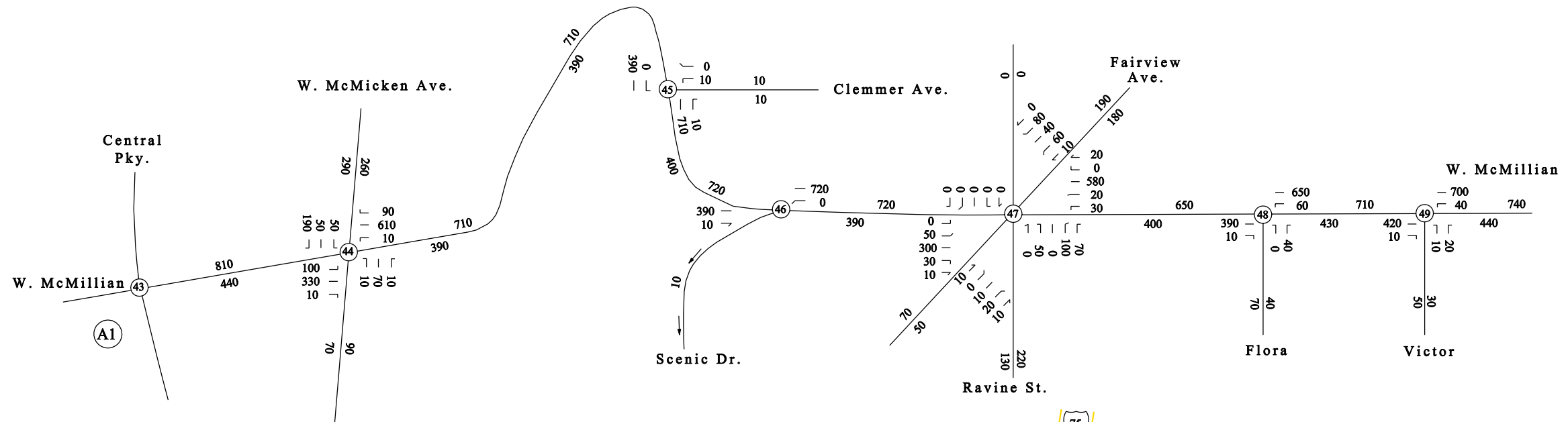

**LEGEND**

- Level of Service A
- Level of Service B
- Level of Service C
- Level of Service D
- Level of Service E
- Level of Service F
- 2569 # of Vehicles per Hour
- (12) Intersection ID #

NOT TO SCALE



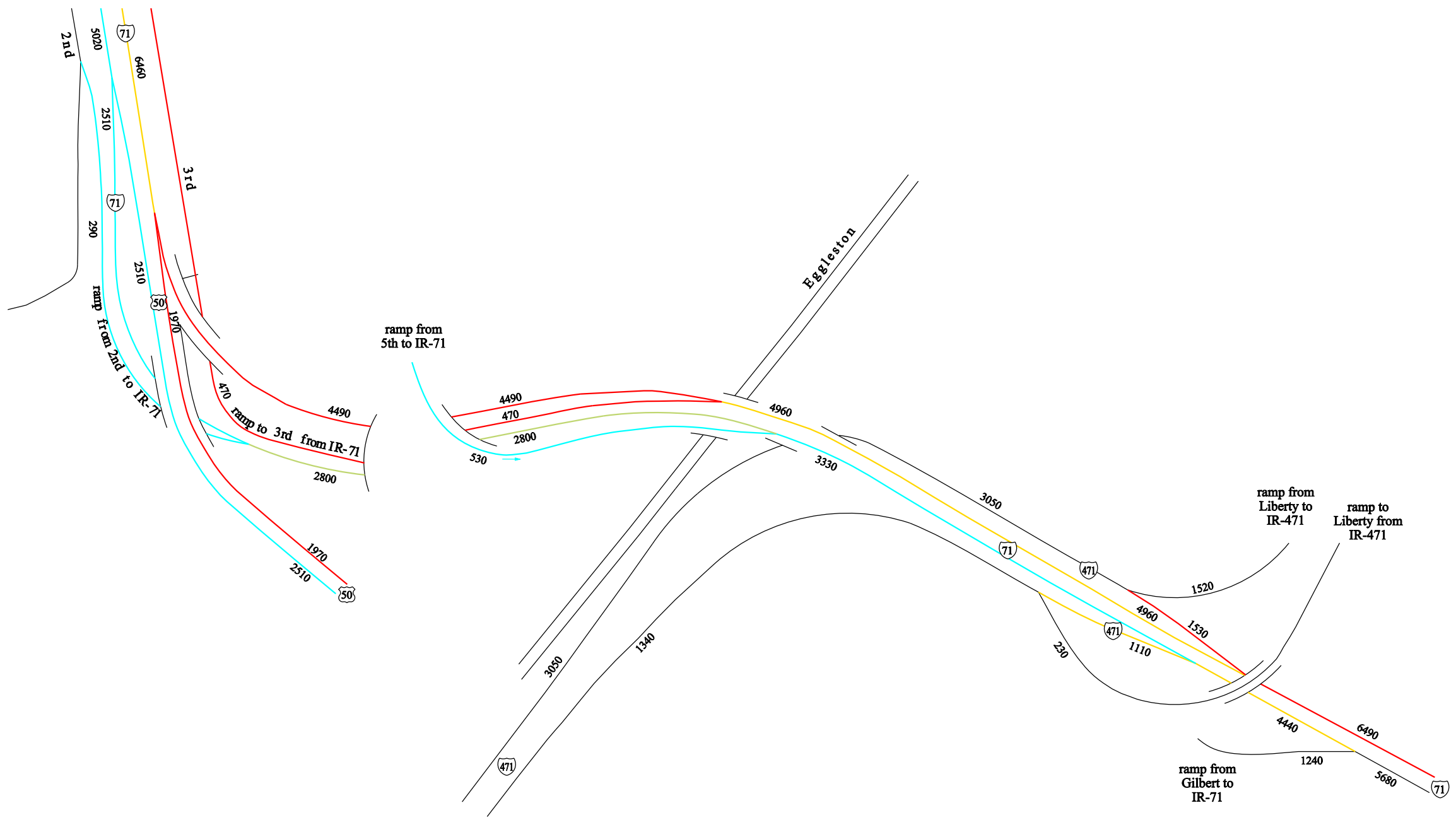

**LEGEND**

- Level of Service A
- Level of Service B
- Level of Service C
- Level of Service D
- Level of Service E
- Level of Service F
- 2569 # of Vehicles per Hour
- (12) Intersection ID #

NOT TO SCALE



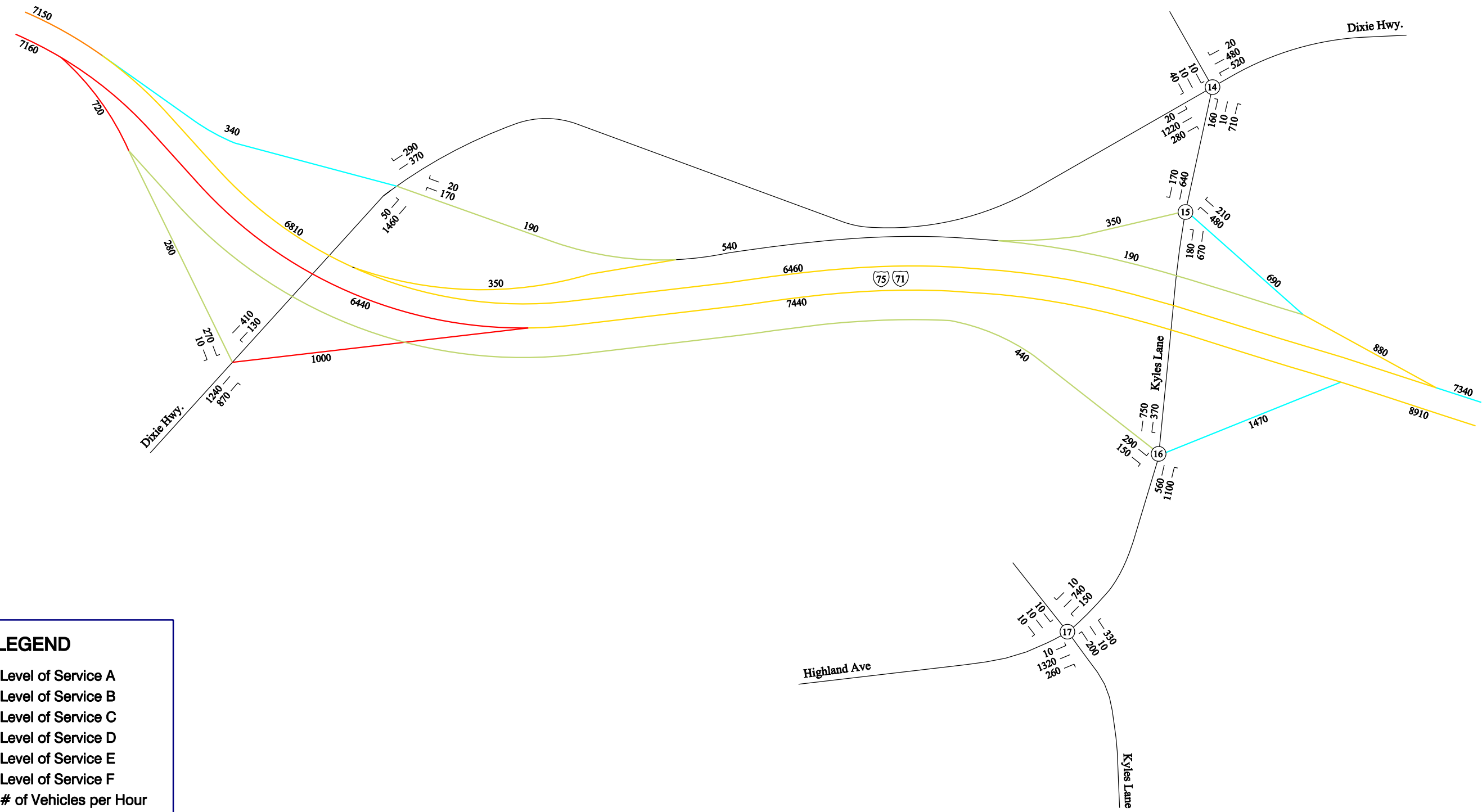

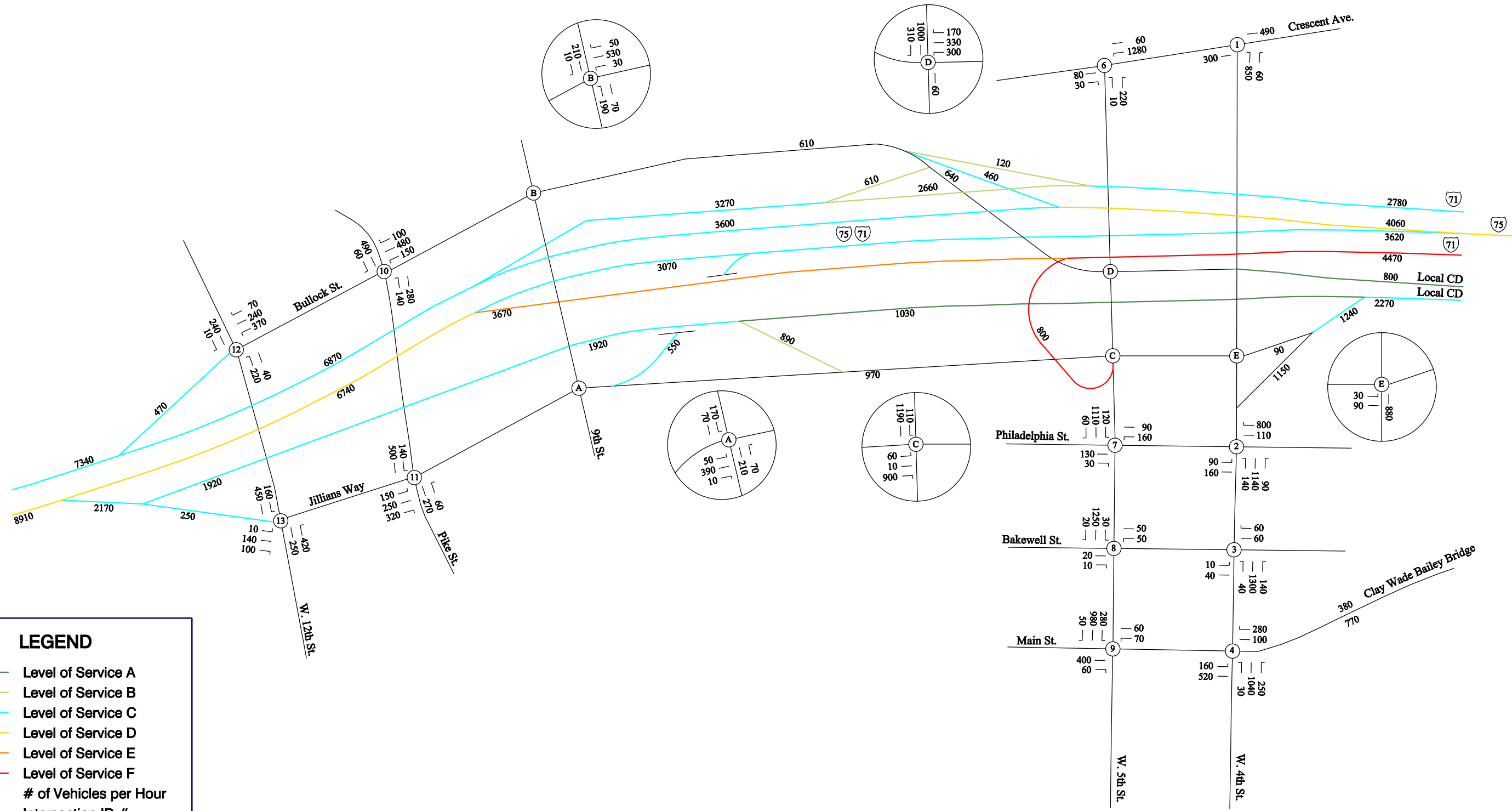

**LEGEND**

- Level of Service A
- Level of Service B
- Level of Service C
- Level of Service D
- Level of Service E
- Level of Service F
- 2569 # of Vehicles per Hour
- (12) Intersection ID #

NOT TO SCALE



**2035 AM LEVEL OF SERVICE  
ALTERNATIVE E  
(KENTUCKY)**

SHEET  
(2 OF 9)

**EXHIBIT  
A9-B**

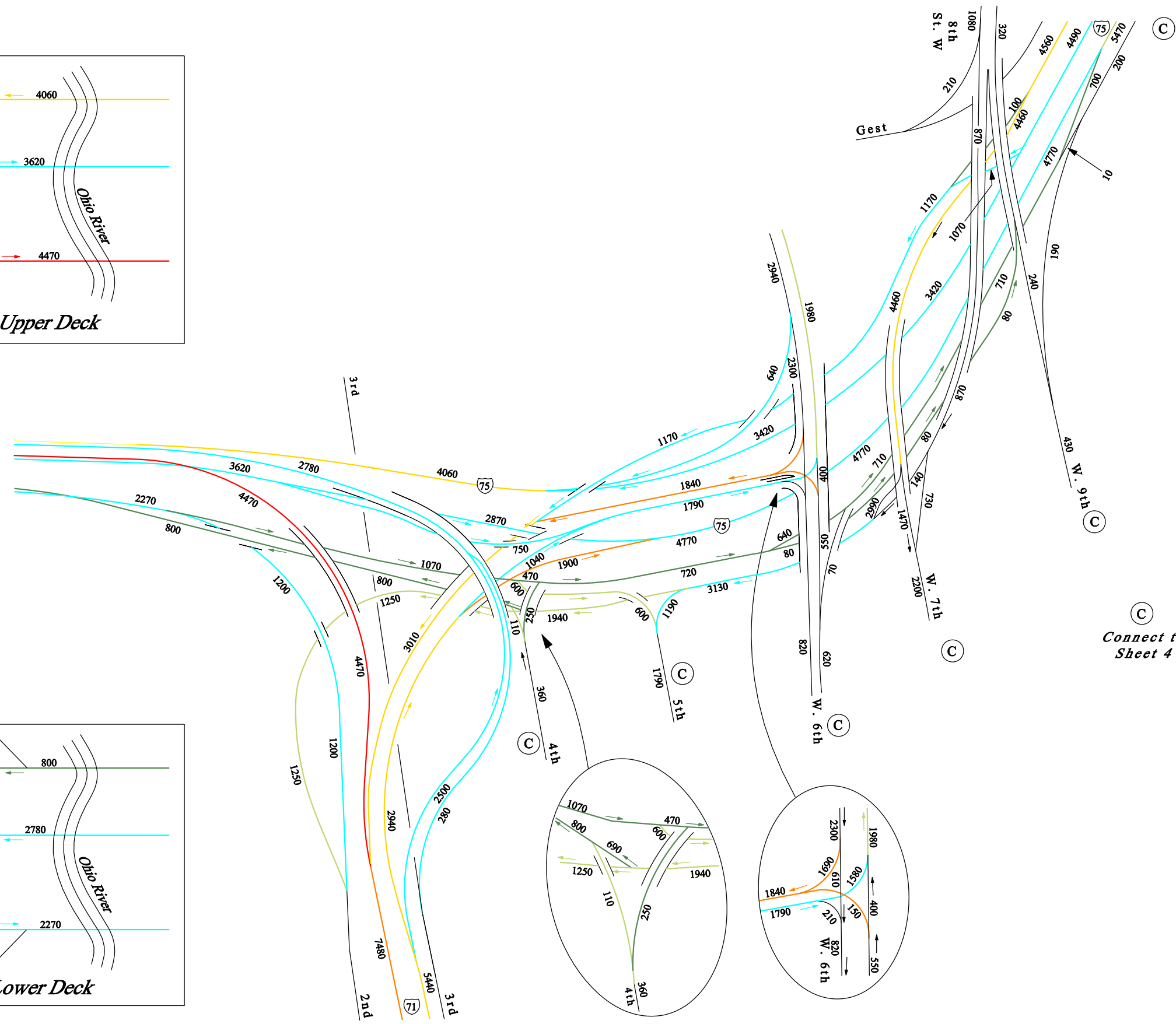
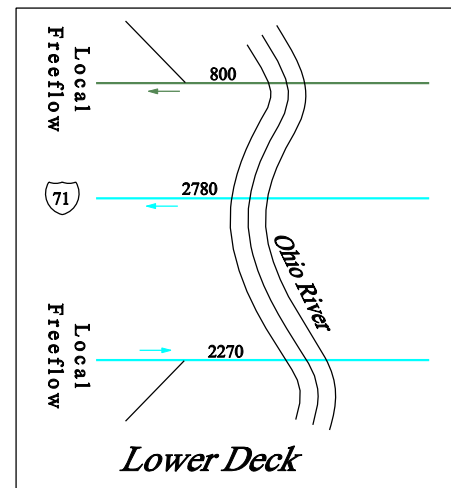
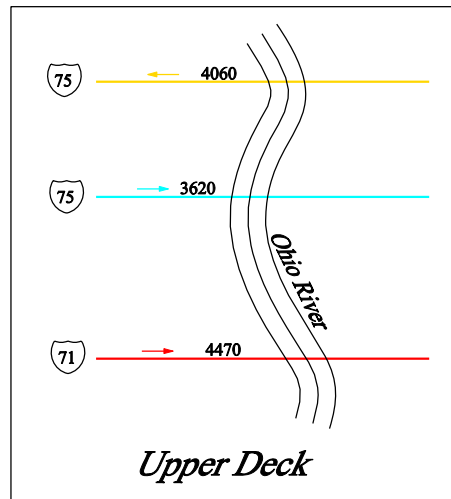

Connect to Sheet 4

**LEGEND**

- Level of Service A
  - Level of Service B
  - Level of Service C
  - Level of Service D
  - Level of Service E
  - Level of Service F
- 2569 # of Vehicles per Hour  
 (12) Intersection ID #

NOT TO SCALE



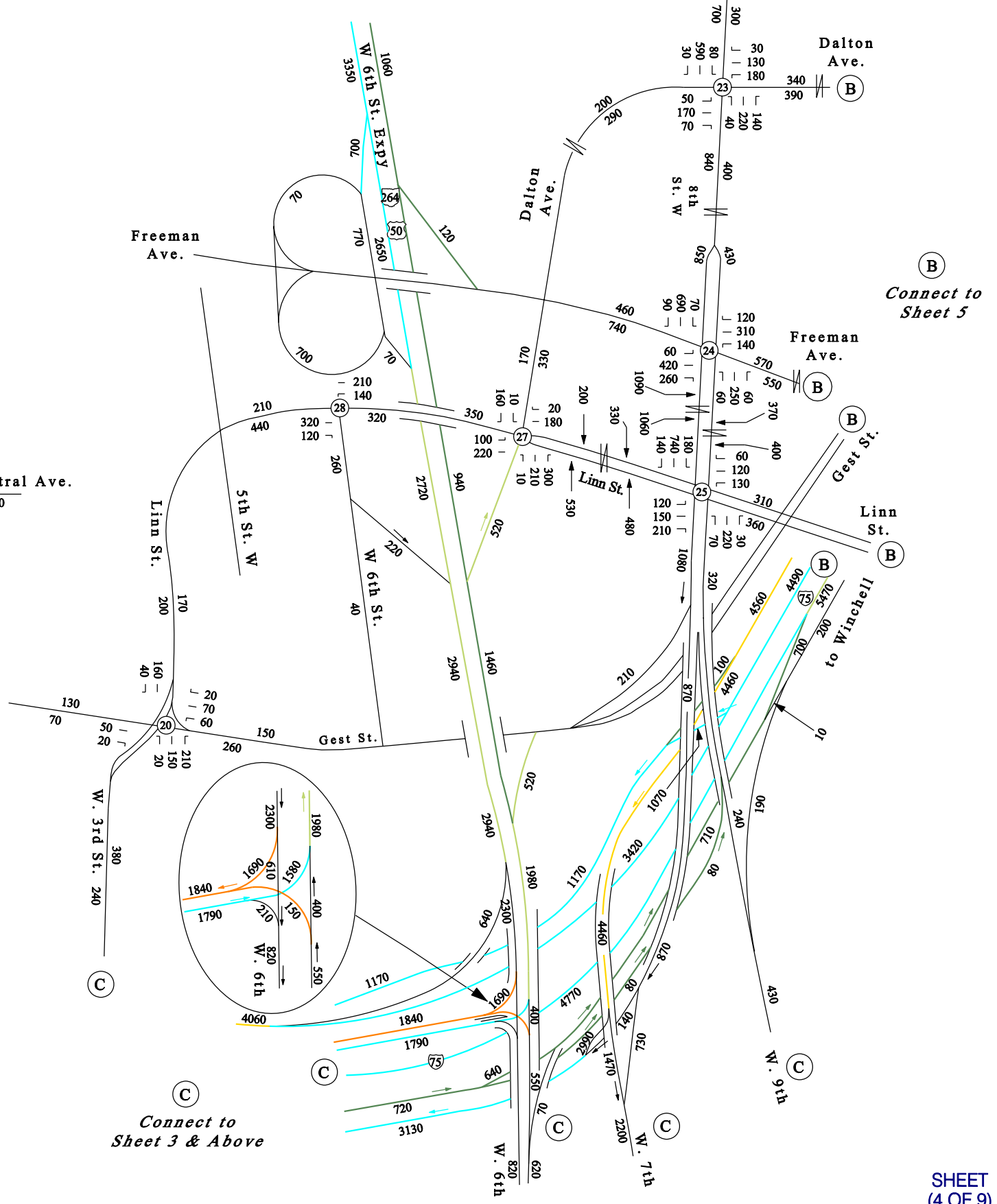
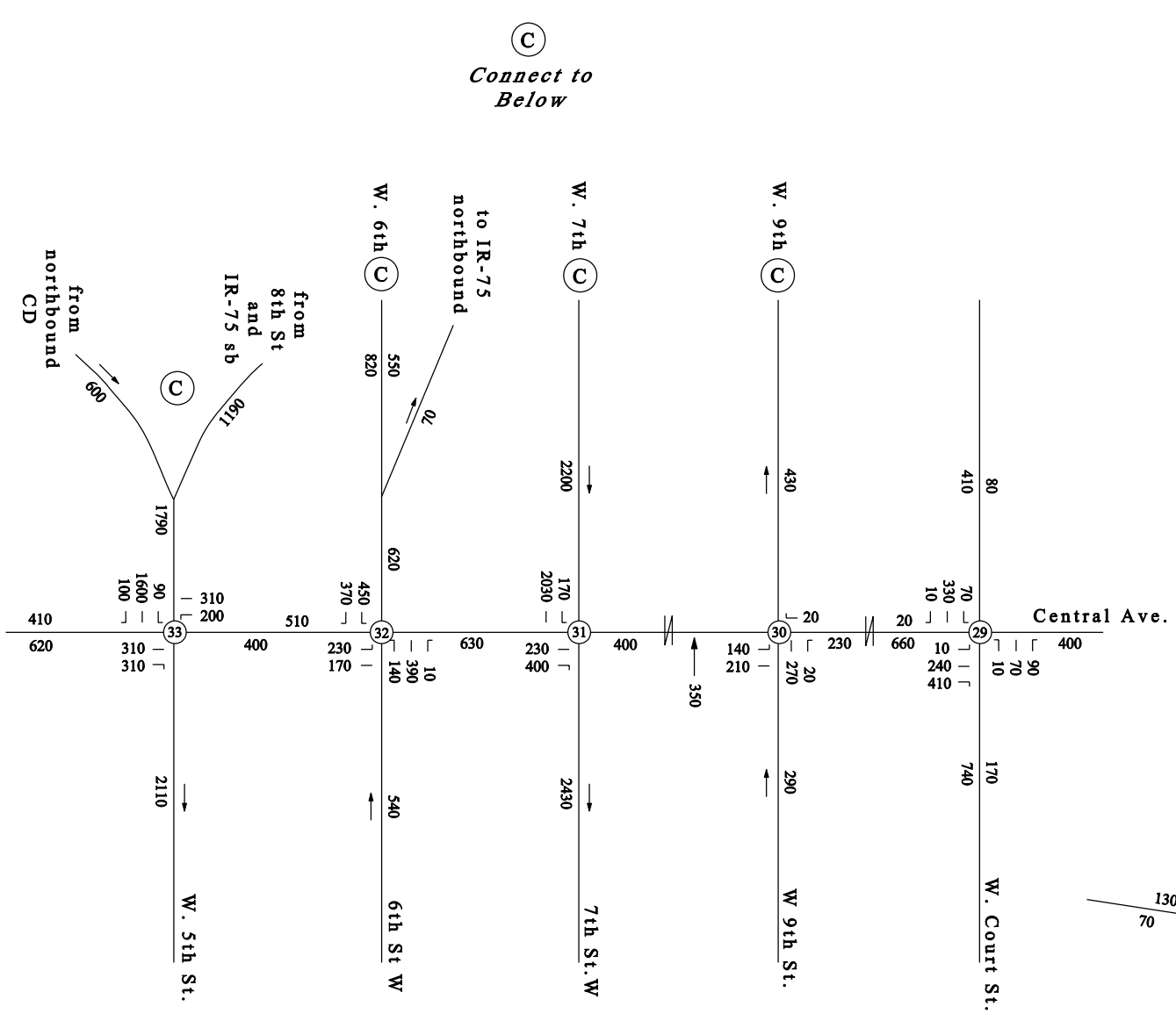

**LEGEND**

- Level of Service A
- Level of Service B
- Level of Service C
- Level of Service D
- Level of Service E
- Level of Service F
- 2569 # of Vehicles per Hour
- (12) Intersection ID #

NOT TO SCALE



**2035 AM LEVEL OF SERVICE ALTERNATIVE E (OHIO)**

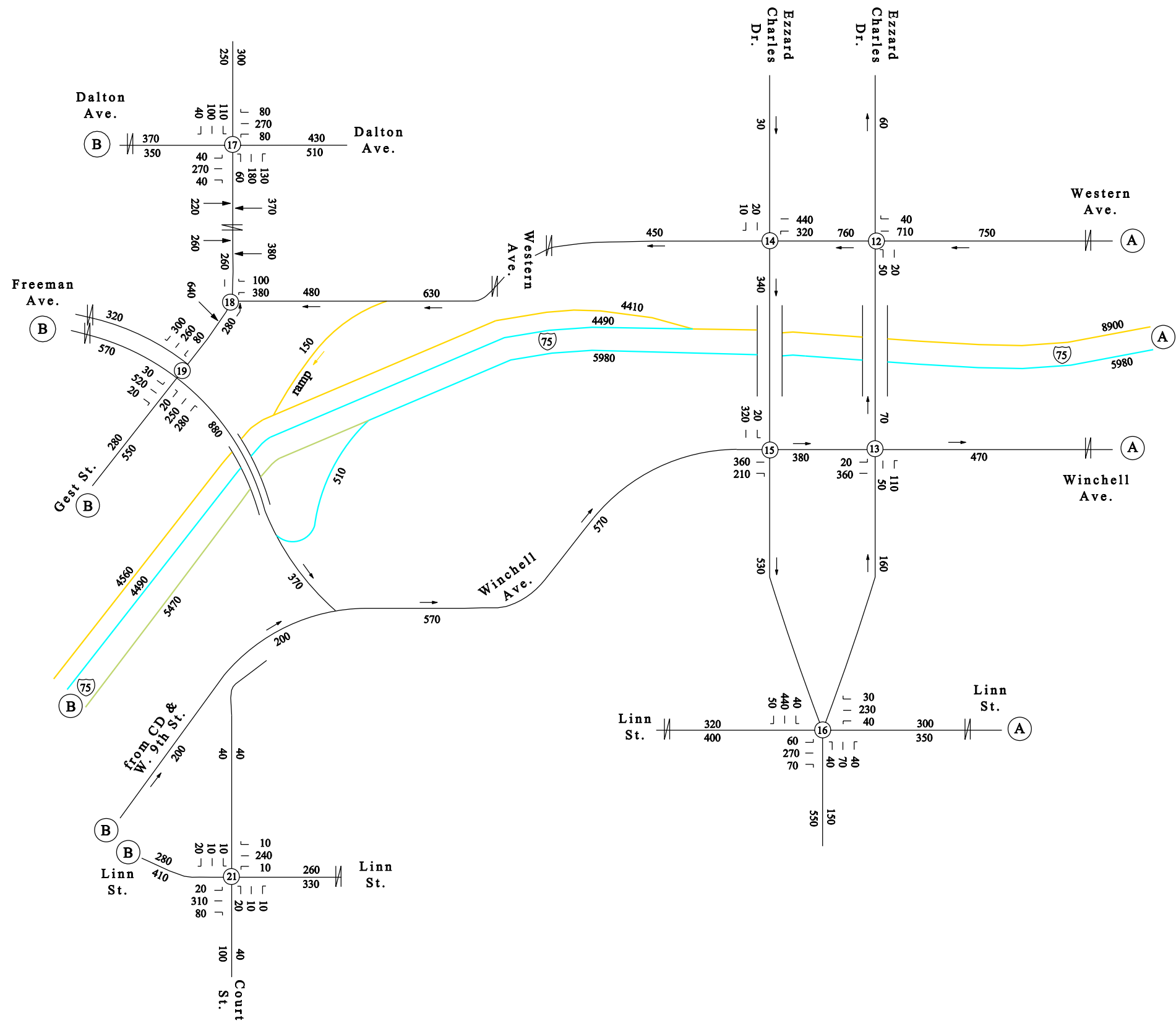

(B)  
Connect to  
Sheet 4

(A)  
Connect to  
Sheet 6

**LEGEND**

- Level of Service A
- Level of Service B
- Level of Service C
- Level of Service D
- Level of Service E
- Level of Service F
- 2569 # of Vehicles per Hour
- (12) Intersection ID #

NOT TO SCALE



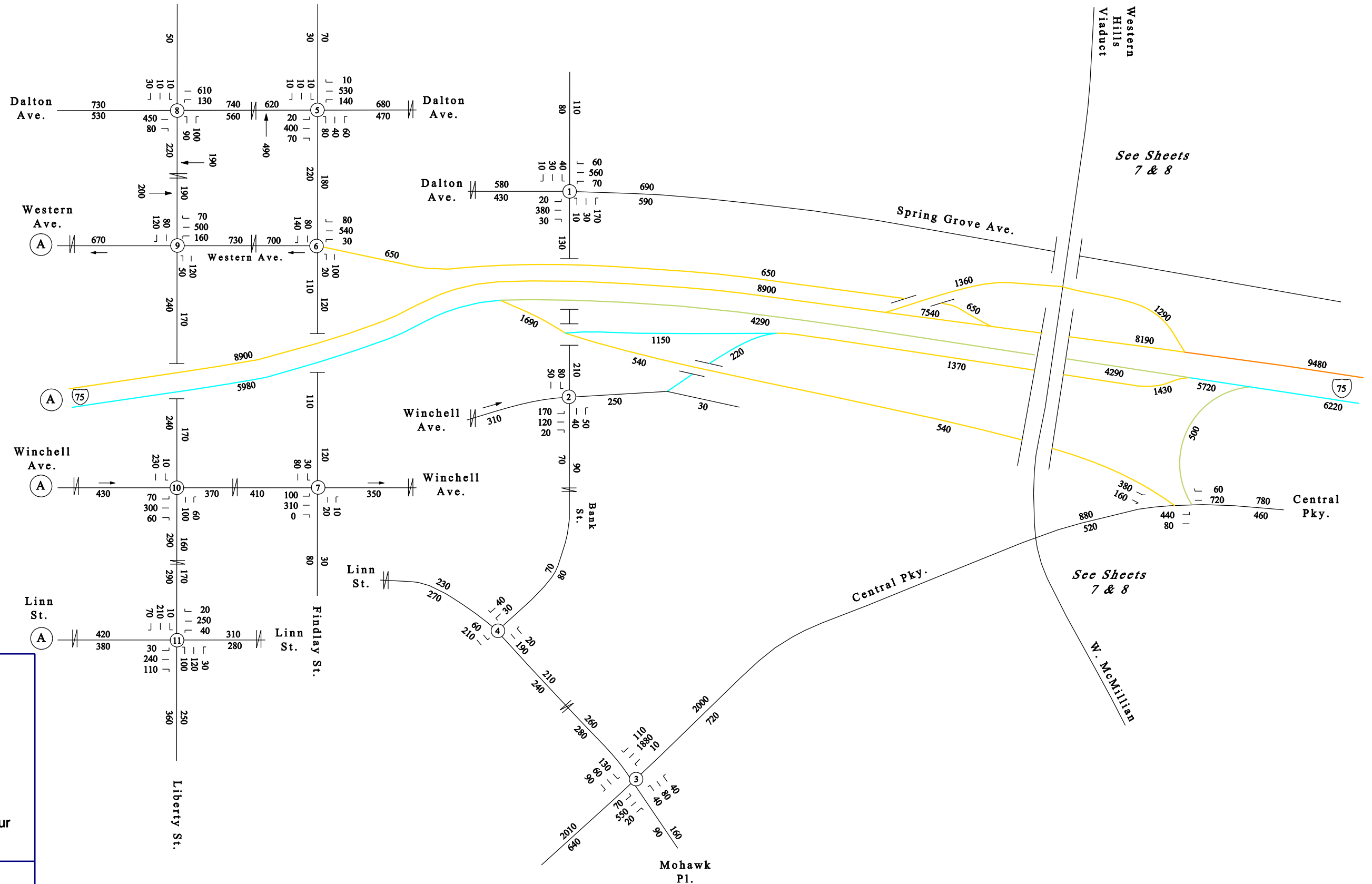

(A)  
Connect to  
Sheet 6

See Sheets  
7 & 8

See Sheets  
7 & 8

**LEGEND**

- Level of Service A
- Level of Service B
- Level of Service C
- Level of Service D
- Level of Service E
- Level of Service F
- 2569 # of Vehicles per Hour
- (12) Intersection ID #

NOT TO SCALE





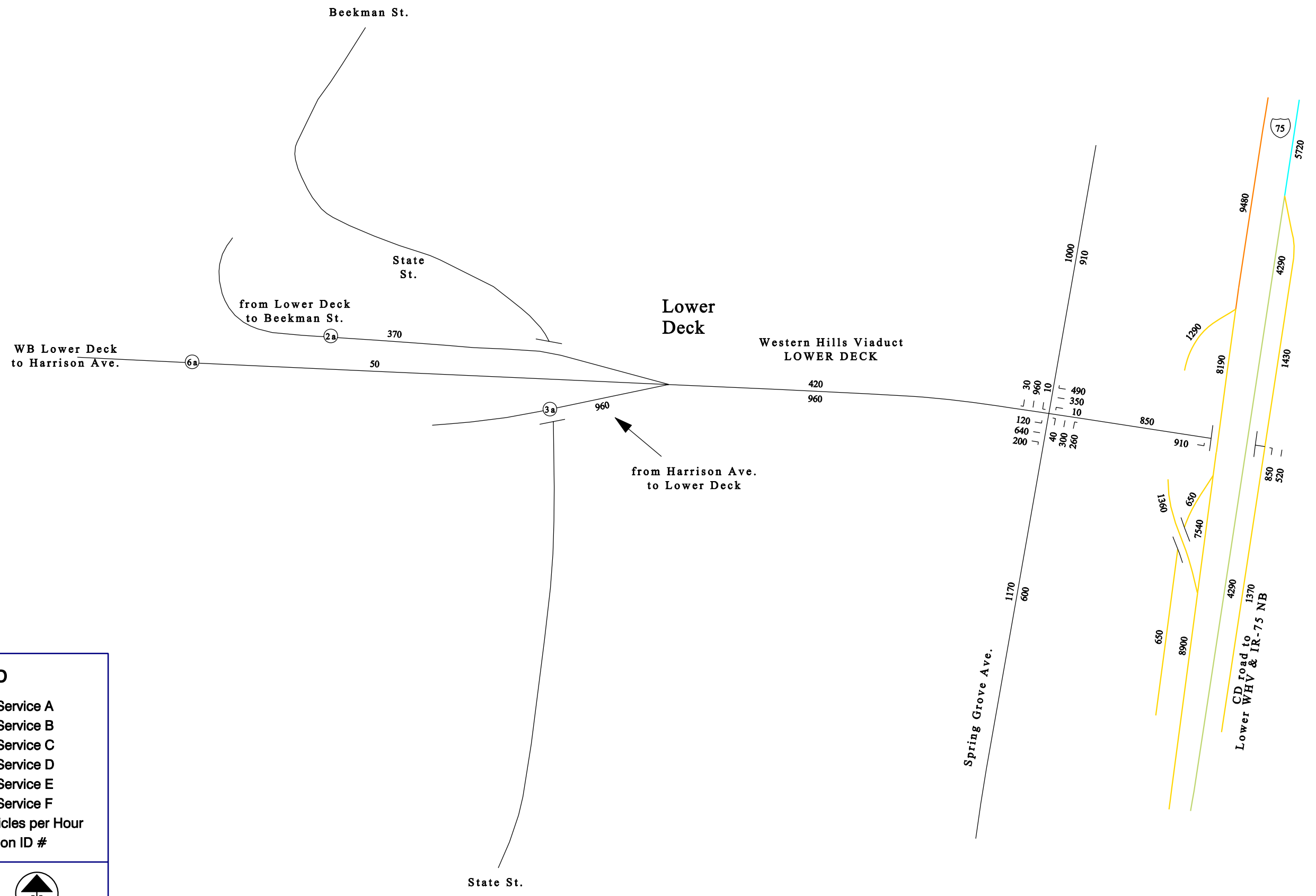

**LEGEND**

- Level of Service A
- Level of Service B
- Level of Service C
- Level of Service D
- Level of Service E
- Level of Service F
- 2569 # of Vehicles per Hour
- (12) Intersection ID #

NOT TO SCALE



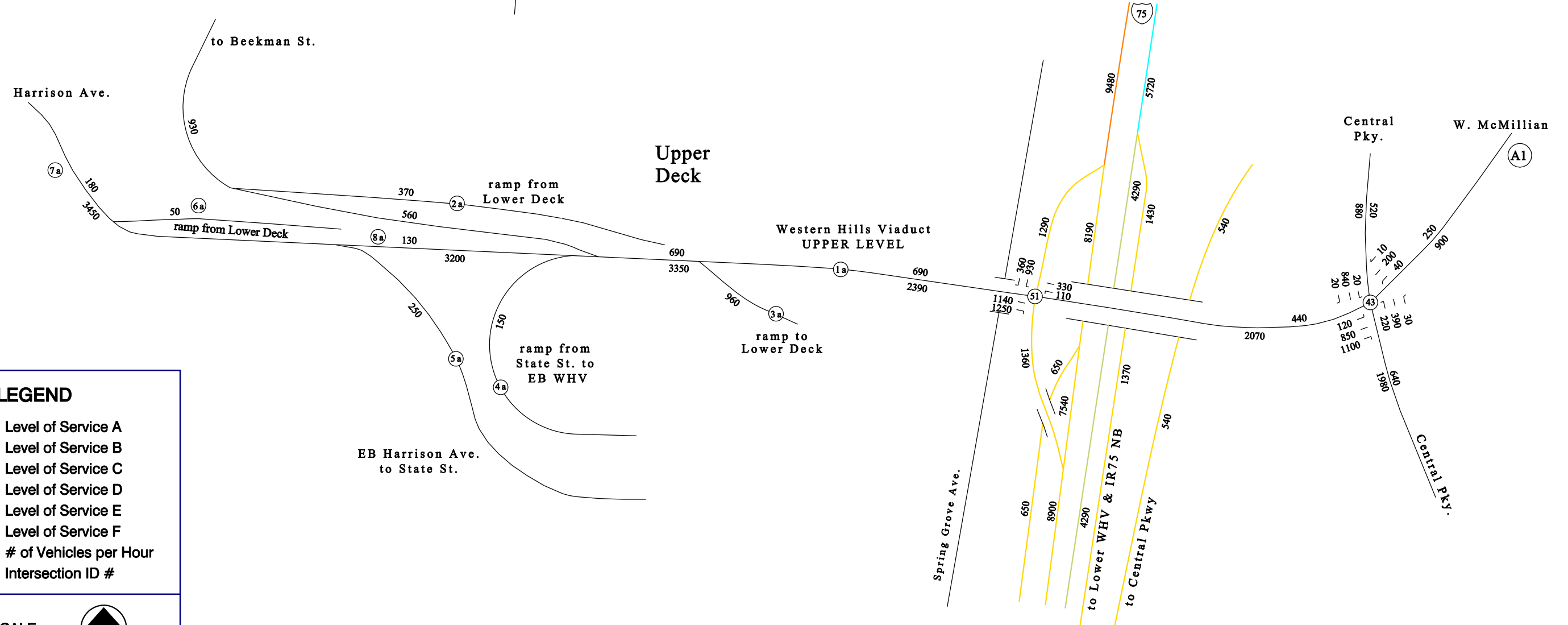
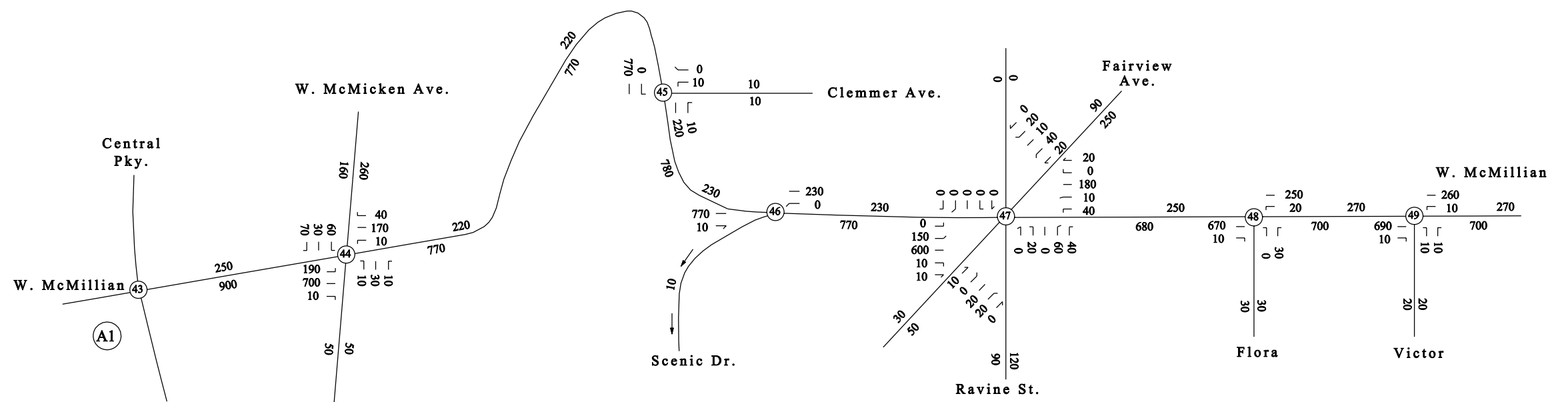

**LEGEND**

- Level of Service A
- Level of Service B
- Level of Service C
- Level of Service D
- Level of Service E
- Level of Service F
- 2569 # of Vehicles per Hour
- (12) Intersection ID #

NOT TO SCALE



**2035 AM LEVEL OF SERVICE  
ALTERNATIVE E  
(OHIO)**

SHEET  
(8 OF 9)

**EXHIBIT  
A9-H**

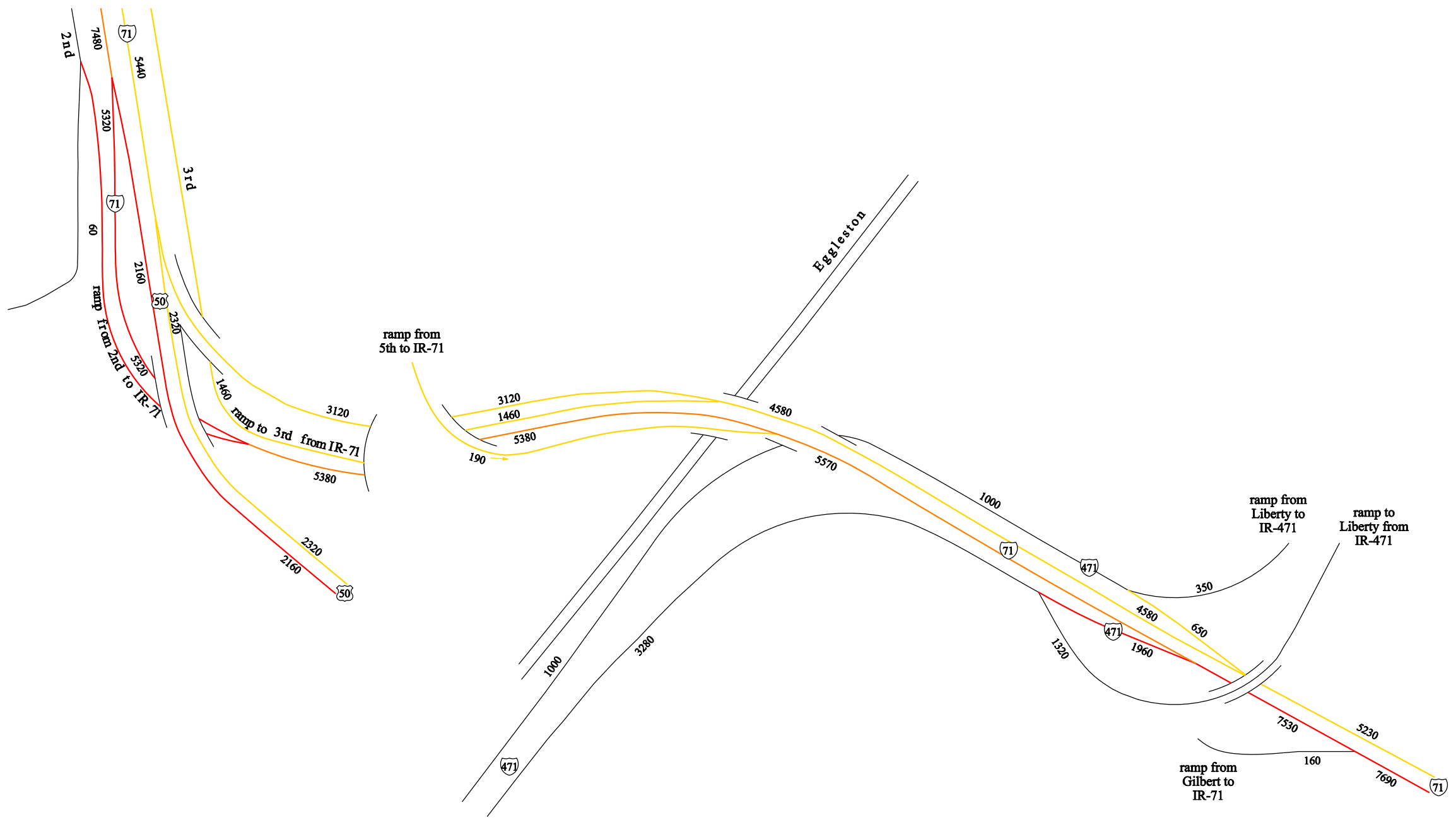

**LEGEND**

- Level of Service A
- Level of Service B
- Level of Service C
- Level of Service D
- Level of Service E
- Level of Service F
- 2569 # of Vehicles per Hour
- (12) Intersection ID #

NOT TO SCALE



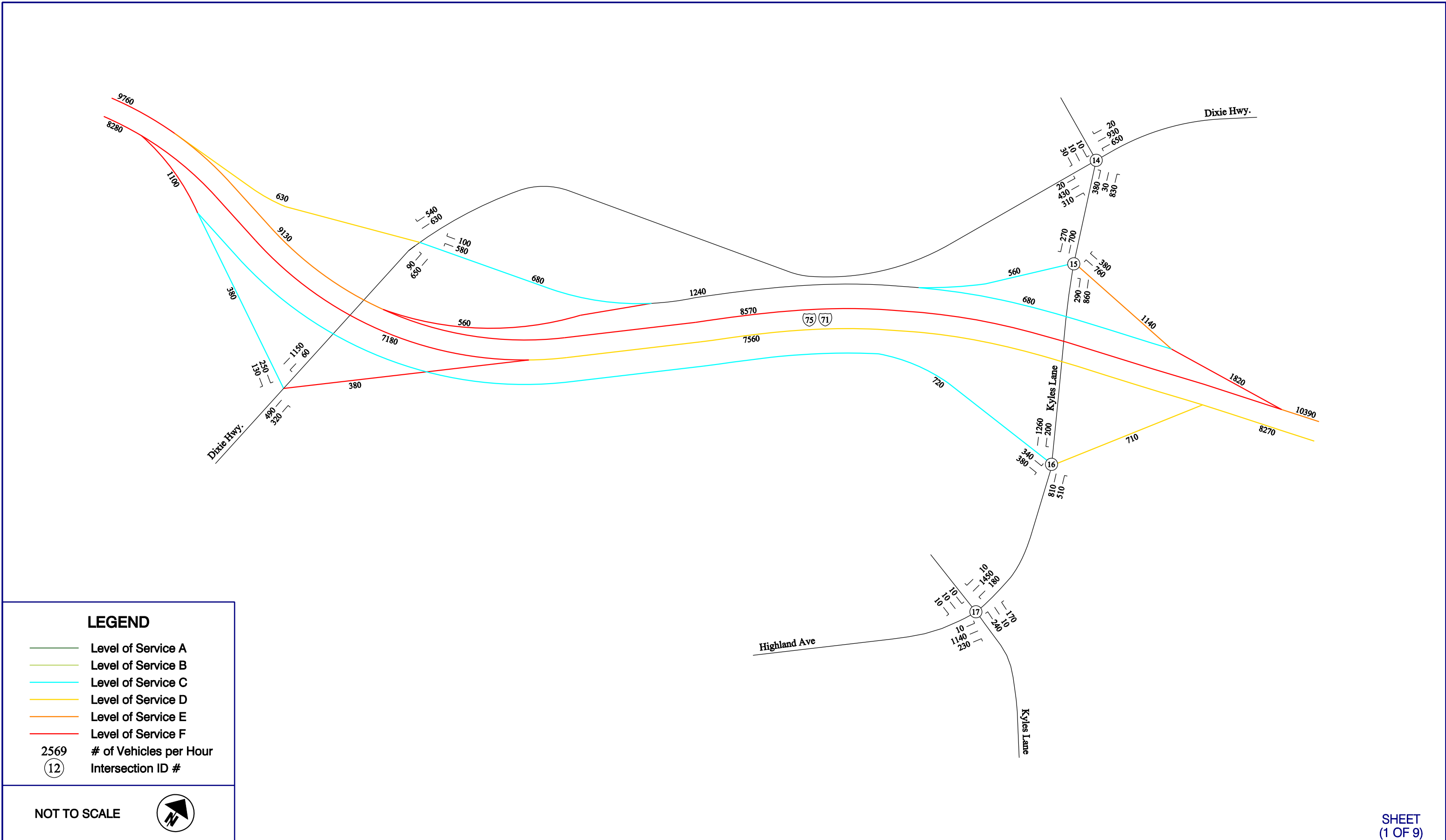

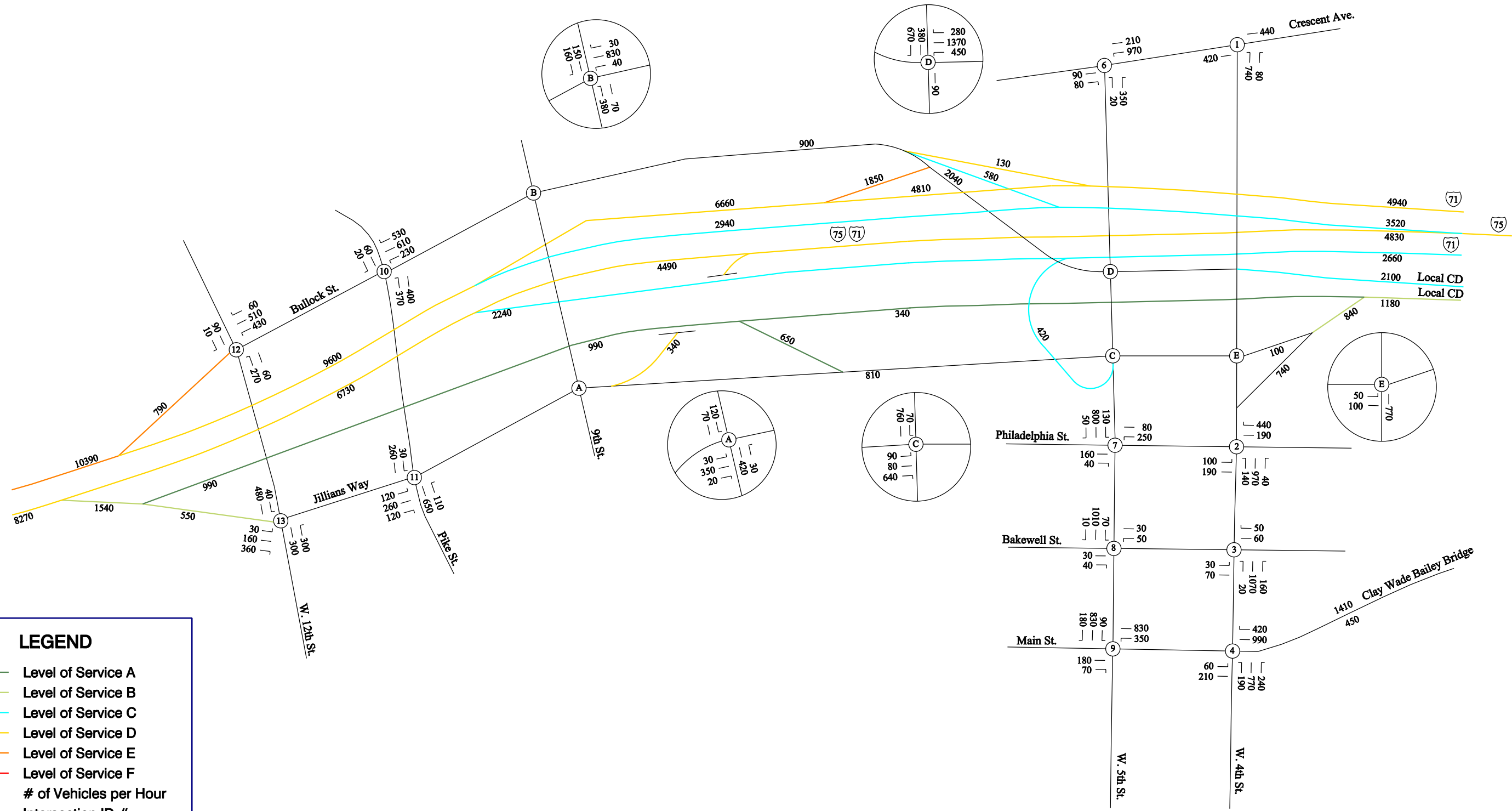

**LEGEND**

- Level of Service A
- Level of Service B
- Level of Service C
- Level of Service D
- Level of Service E
- Level of Service F
- 2569 # of Vehicles per Hour
- (12) Intersection ID #

NOT TO SCALE



**2035 PM LEVEL OF SERVICE  
ALTERNATIVE E  
(KENTUCKY)**

SHEET  
(2 OF 9)

**EXHIBIT  
A10-B**

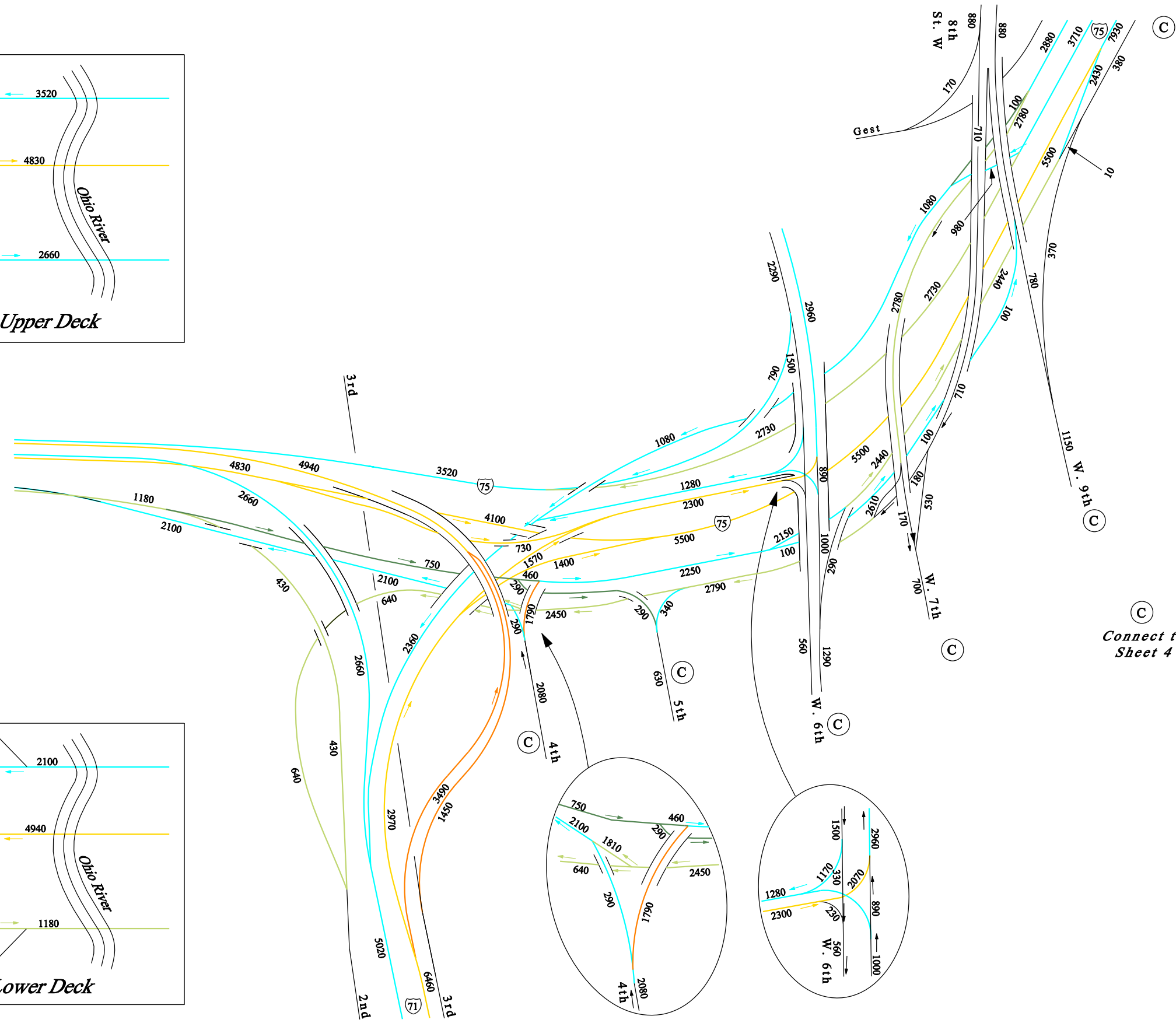
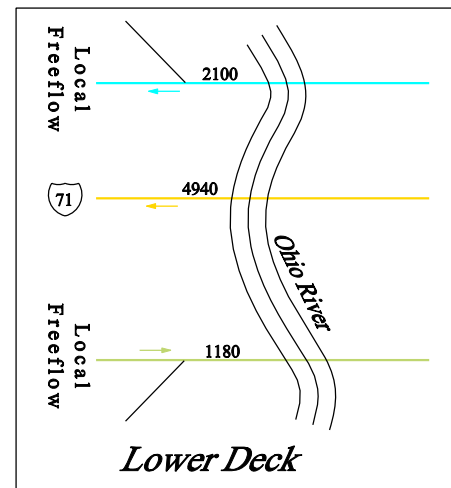
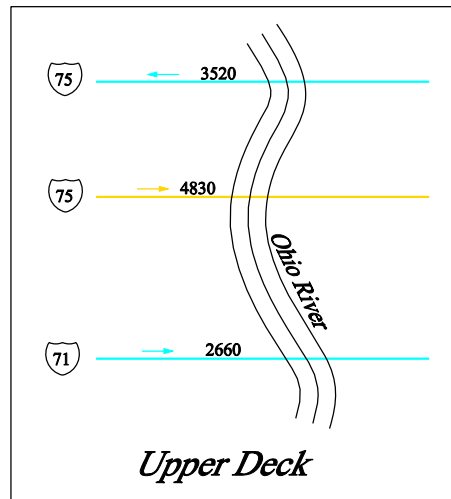

Connect to Sheet 4

**LEGEND**

- Level of Service A
  - Level of Service B
  - Level of Service C
  - Level of Service D
  - Level of Service E
  - Level of Service F
- 2569 # of Vehicles per Hour  
 (12) Intersection ID #

NOT TO SCALE



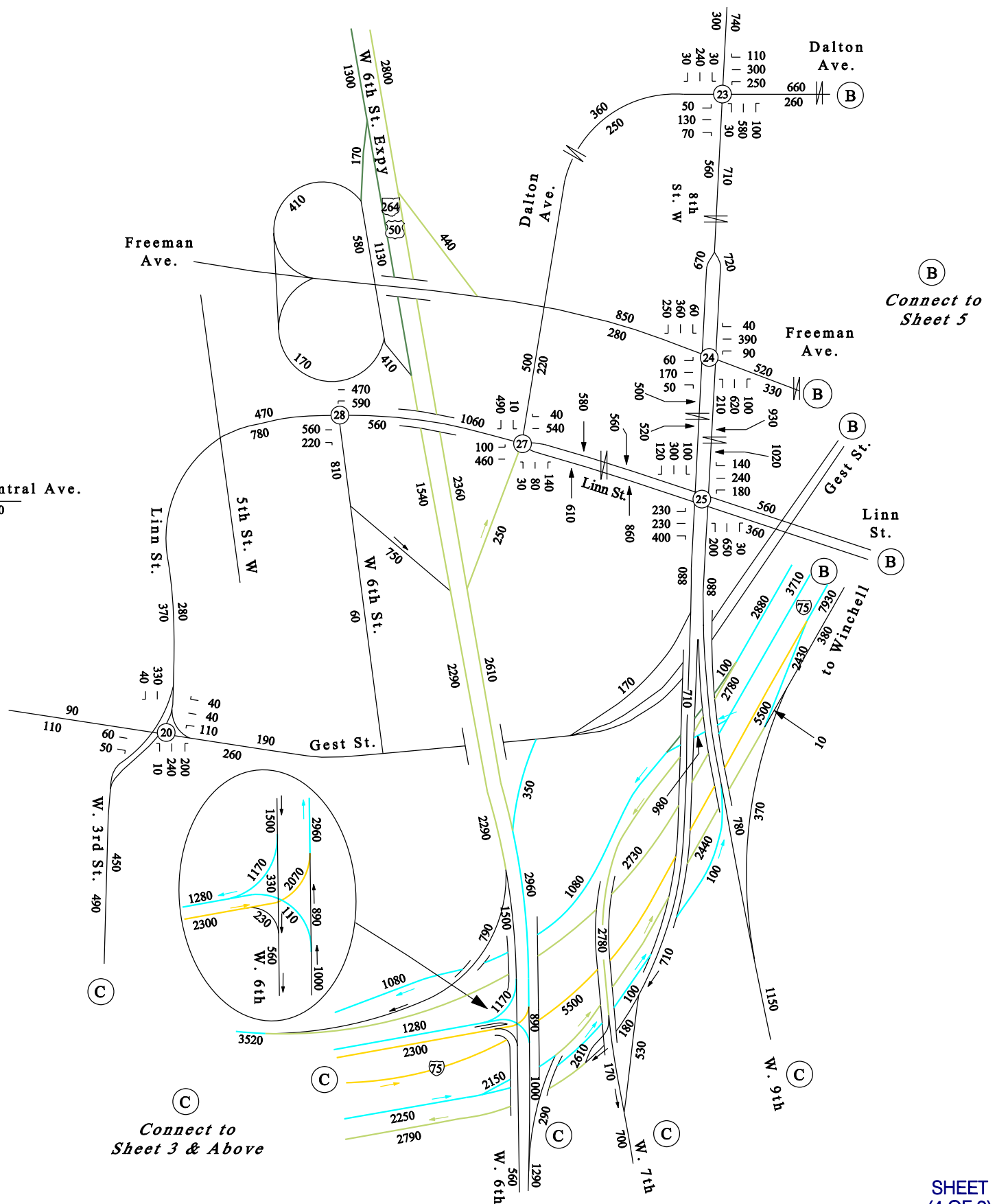
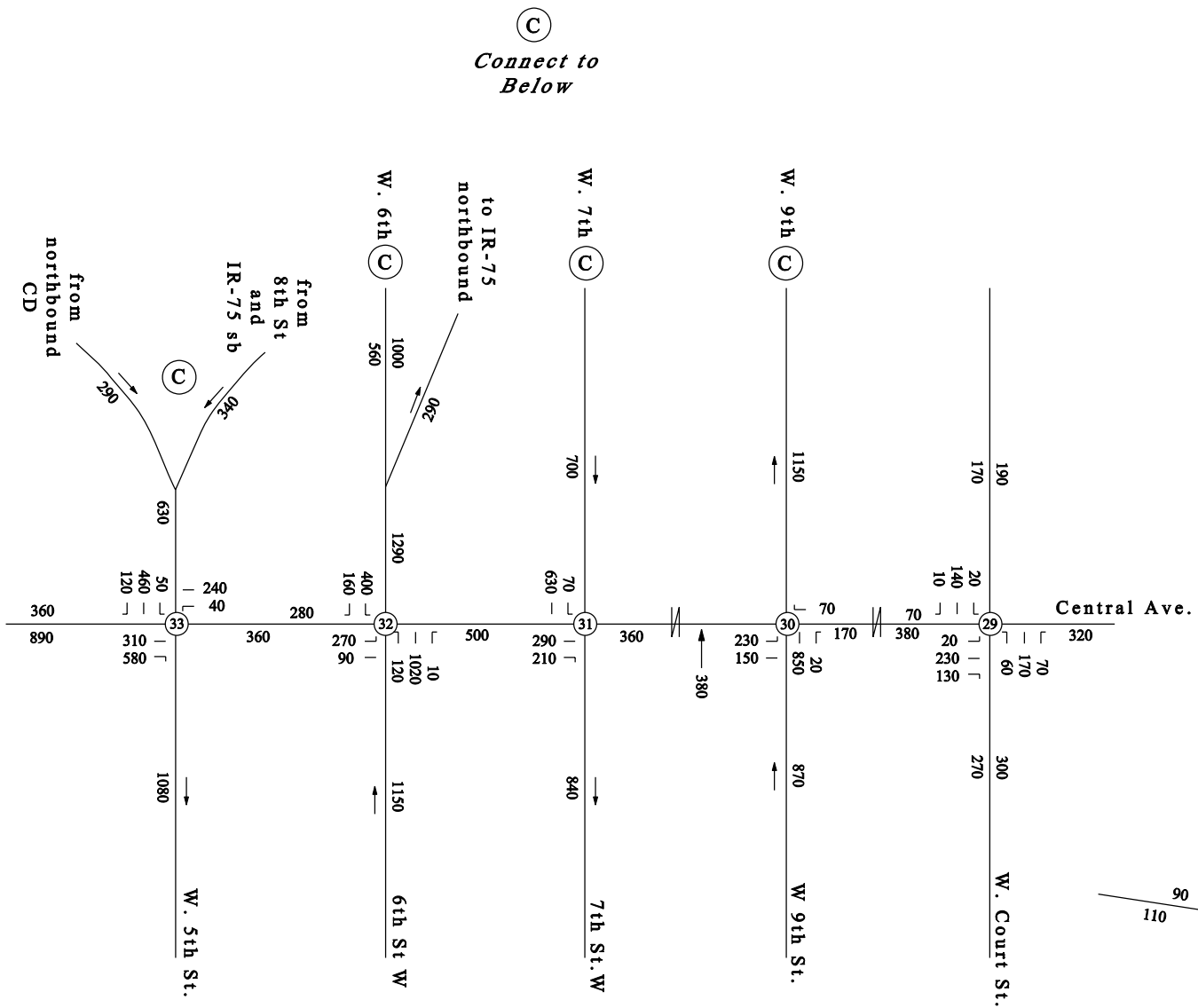

**LEGEND**

- Level of Service A
- Level of Service B
- Level of Service C
- Level of Service D
- Level of Service E
- Level of Service F
- 2569 # of Vehicles per Hour
- (12) Intersection ID #

NOT TO SCALE



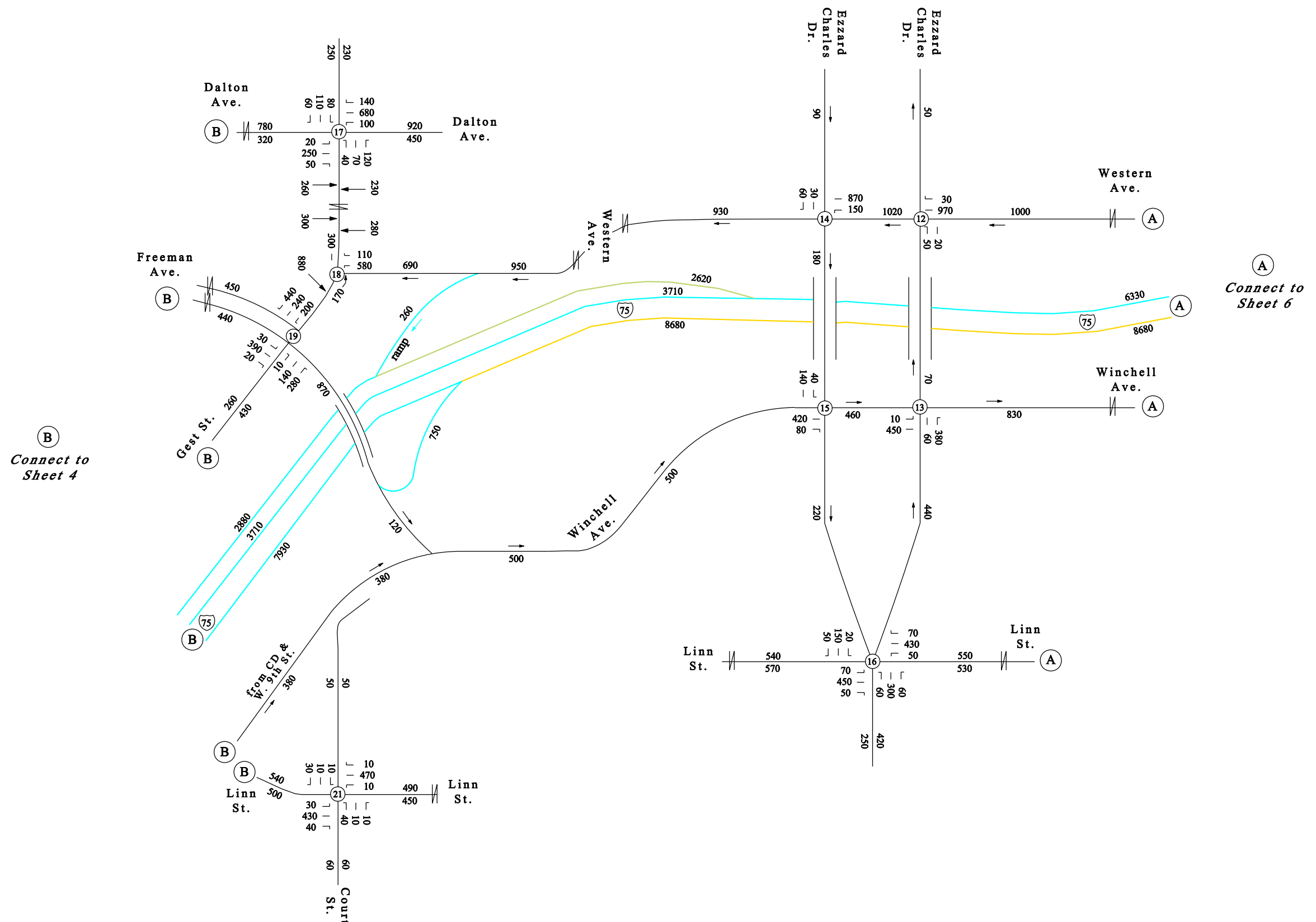

(B) Connect to Sheet 4

(A) Connect to Sheet 6

**LEGEND**

- Level of Service A
- Level of Service B
- Level of Service C
- Level of Service D
- Level of Service E
- Level of Service F
- 2569 # of Vehicles per Hour
- (12) Intersection ID #

NOT TO SCALE





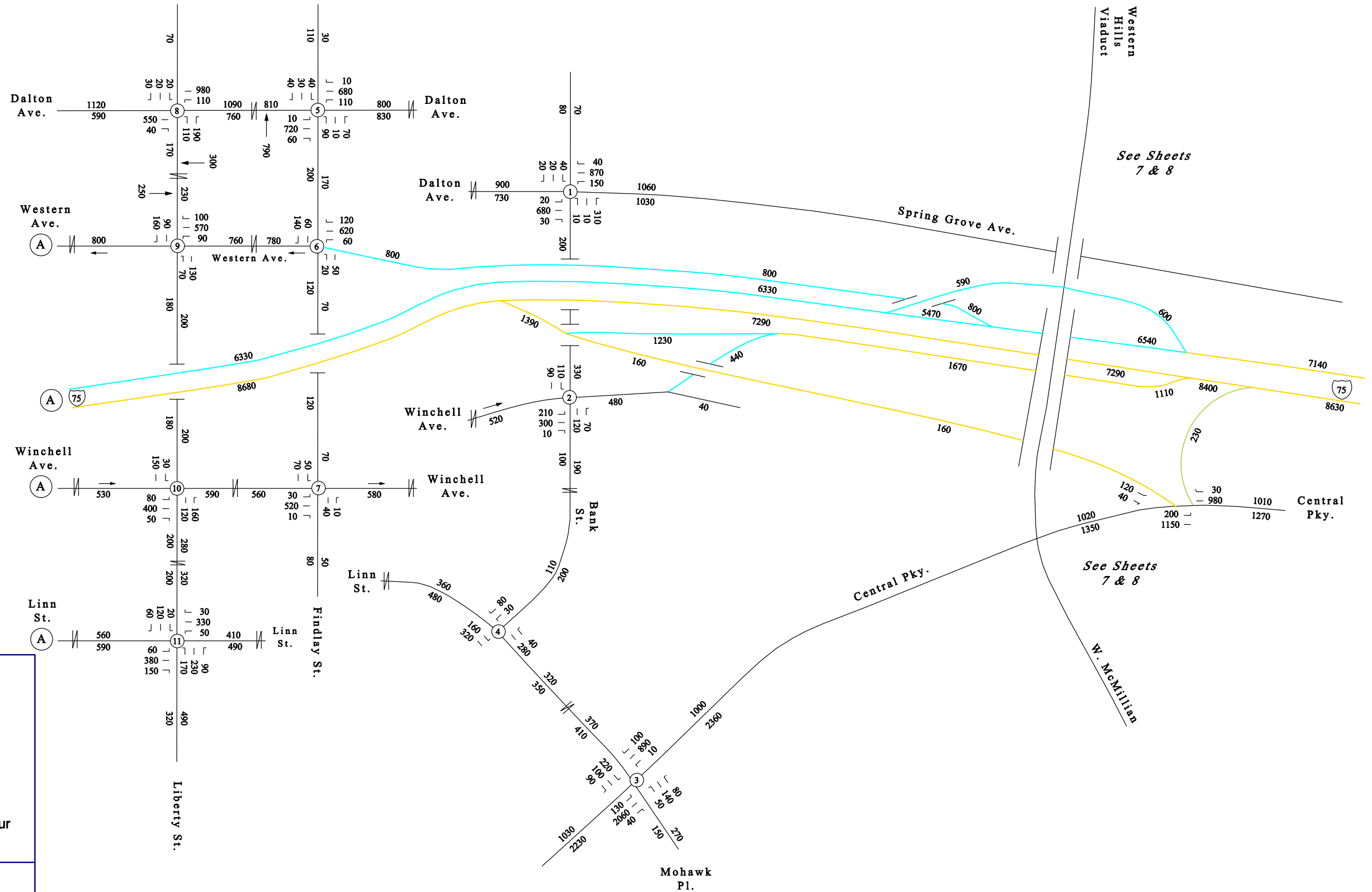

A  
Connect to  
Sheet 6

See Sheets  
7 & 8

See Sheets  
7 & 8

**LEGEND**

- Level of Service A
- Level of Service B
- Level of Service C
- Level of Service D
- Level of Service E
- Level of Service F
- 2569 # of Vehicles per Hour
- (12) Intersection ID #

NOT TO SCALE



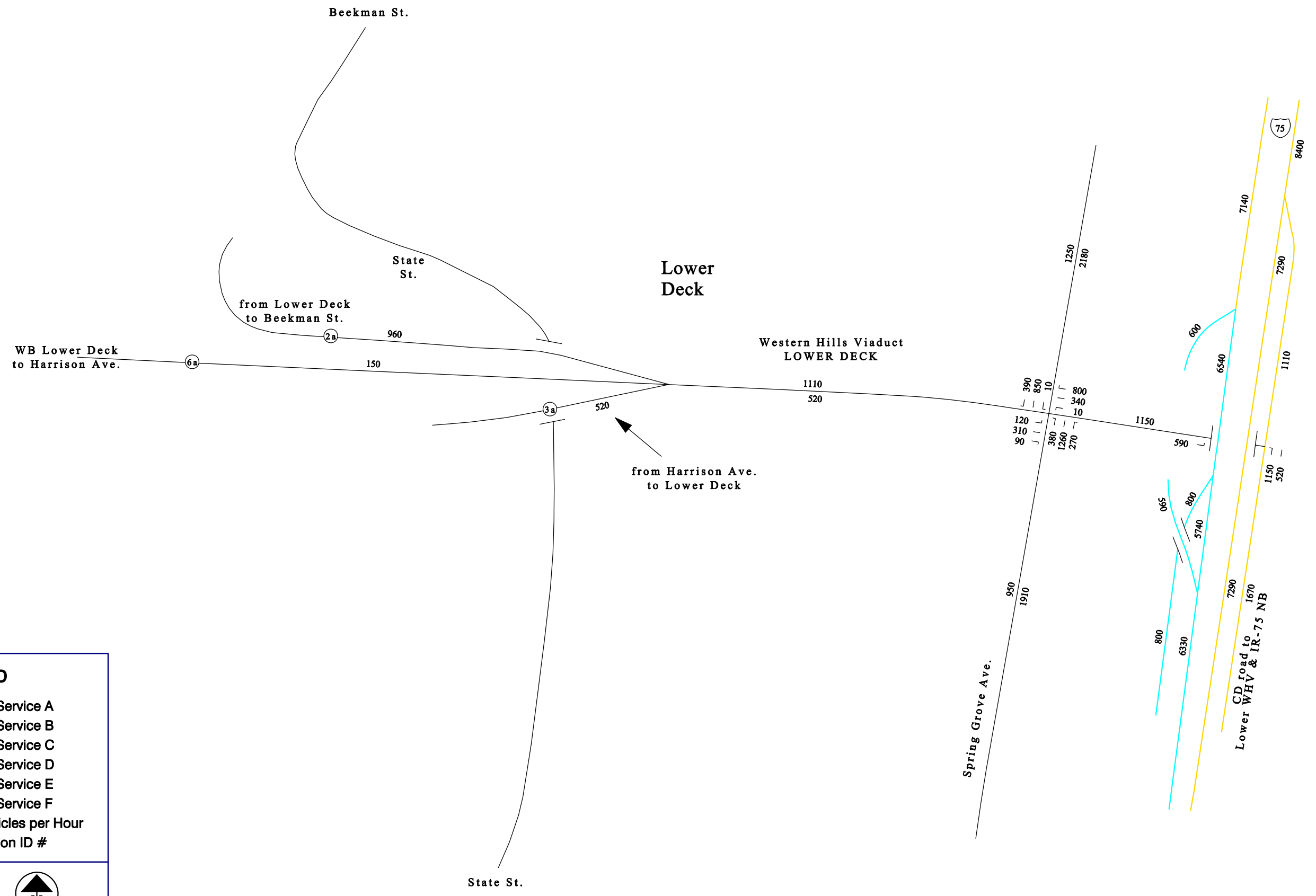

**LEGEND**

- Level of Service A
  - Level of Service B
  - Level of Service C
  - Level of Service D
  - Level of Service E
  - Level of Service F
- 2569 # of Vehicles per Hour  
 (12) Intersection ID #

NOT TO SCALE



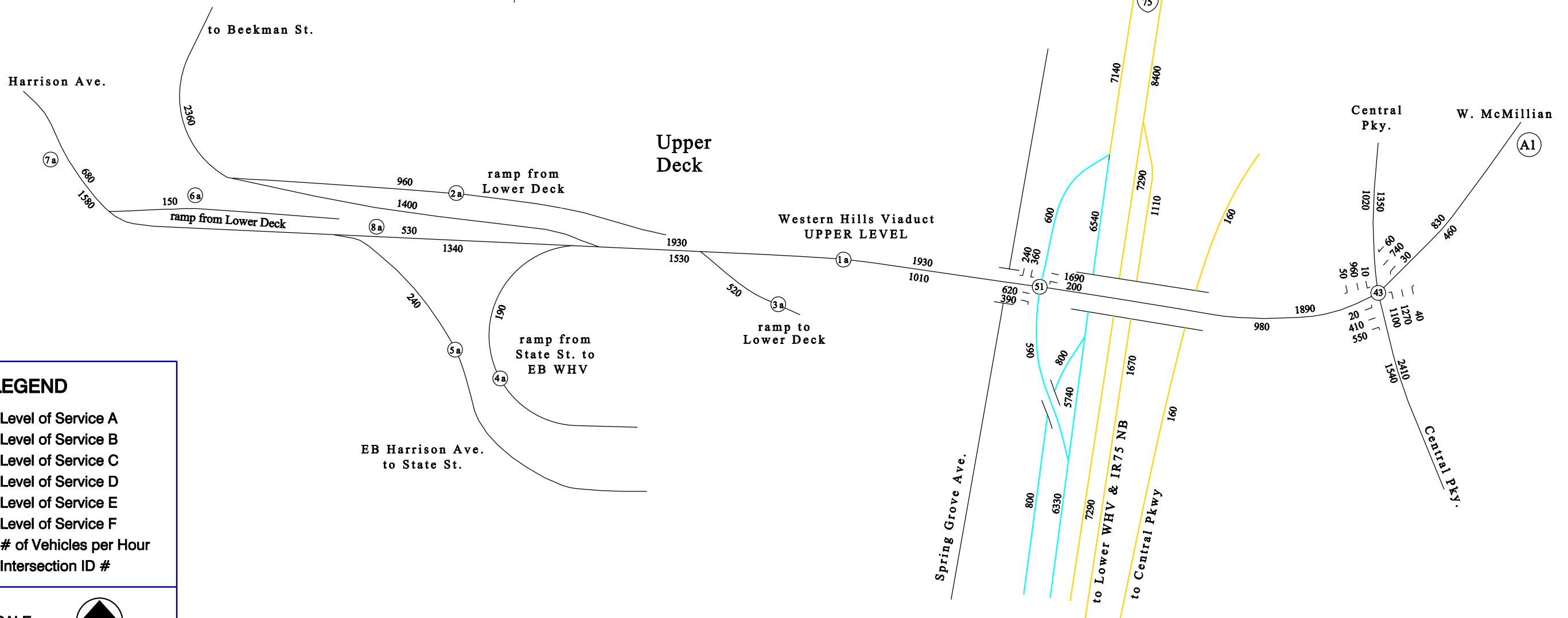
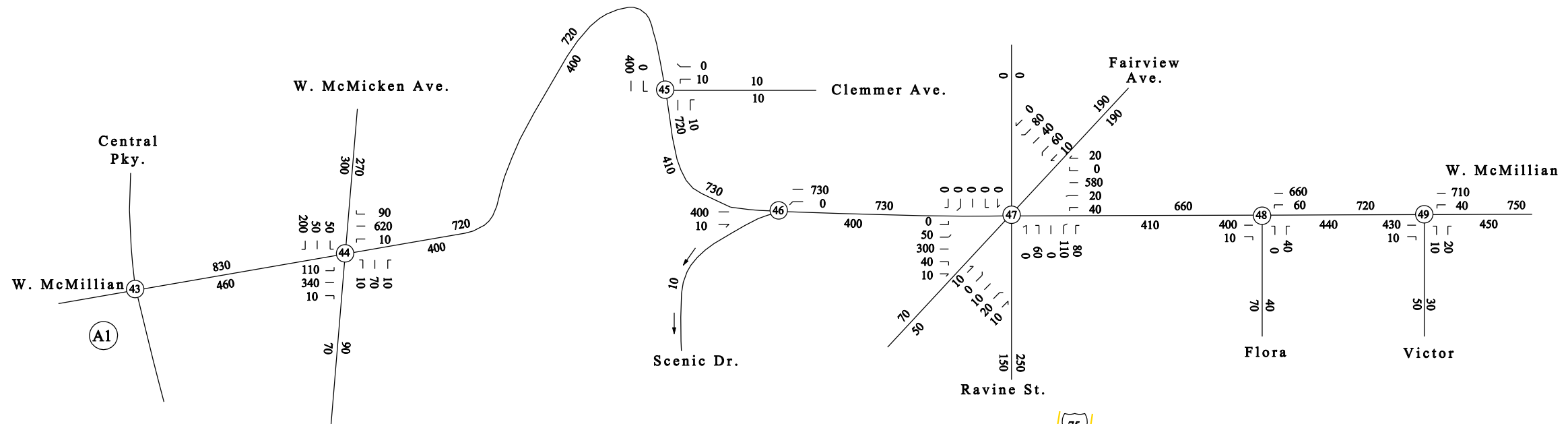

**LEGEND**

- Level of Service A
- Level of Service B
- Level of Service C
- Level of Service D
- Level of Service E
- Level of Service F
- 2569 # of Vehicles per Hour
- (12) Intersection ID #

NOT TO SCALE



**2035 PM LEVEL OF SERVICE  
ALTERNATIVE E  
(OHIO)**

SHEET  
(8 OF 9)

**EXHIBIT  
A10-H**

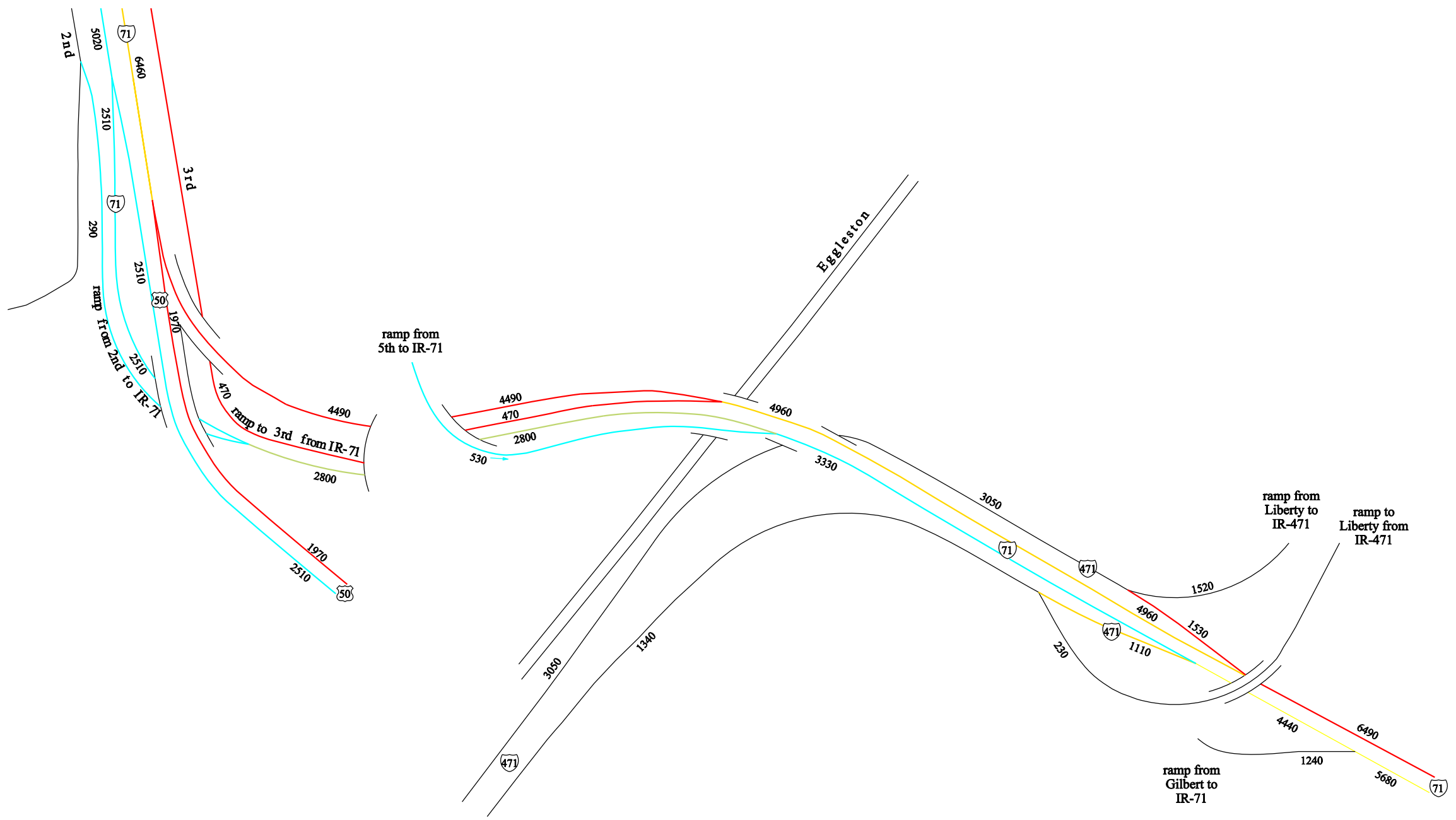

**LEGEND**

- Level of Service A
- Level of Service B
- Level of Service C
- Level of Service D
- Level of Service E
- Level of Service F
- 2569 # of Vehicles per Hour
- (12) Intersection ID #

NOT TO SCALE



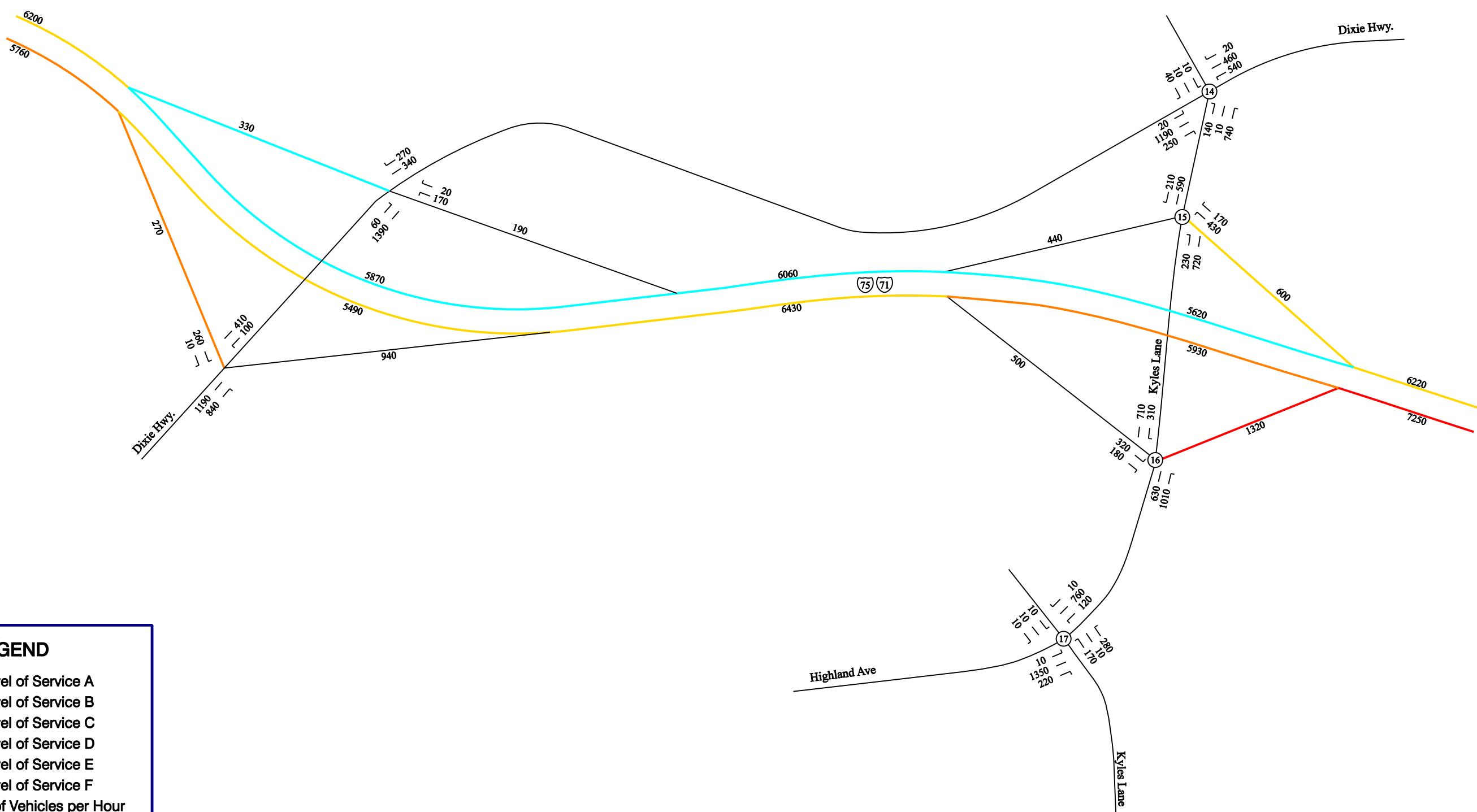

**LEGEND**

- Level of Service A
- Level of Service B
- Level of Service C
- Level of Service D
- Level of Service E
- Level of Service F
- 2569 # of Vehicles per Hour
- (12) Intersection ID #

NOT TO SCALE



**2035 AM LEVEL OF SERVICE  
NO BUILD ALTERNATIVE  
(KENTUCKY)**

SHEET  
(1 OF 9)

**EXHIBIT  
A1-A**

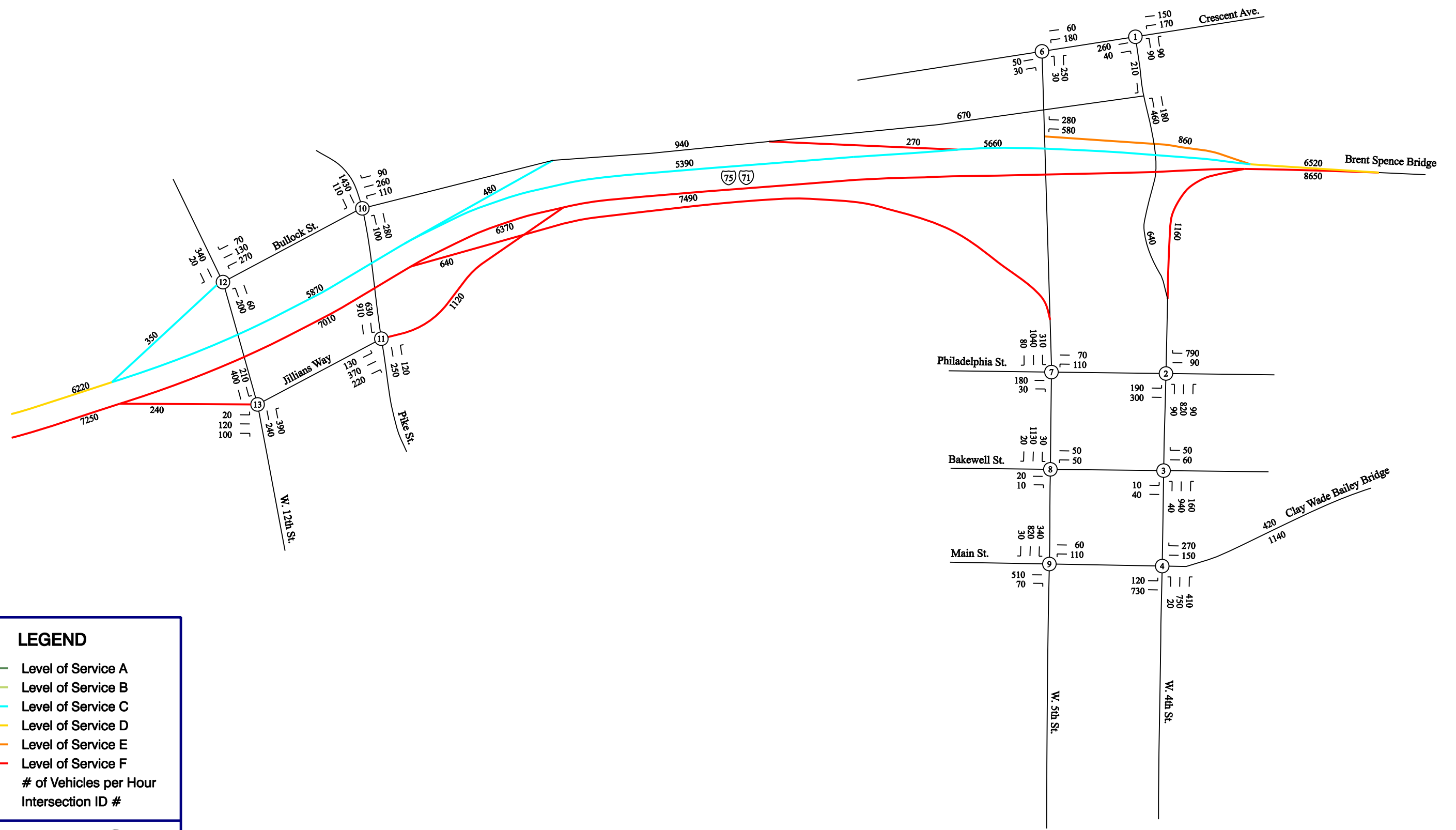

**LEGEND**

- Level of Service A
- Level of Service B
- Level of Service C
- Level of Service D
- Level of Service E
- Level of Service F
- 2569 # of Vehicles per Hour
- (12) Intersection ID #

NOT TO SCALE



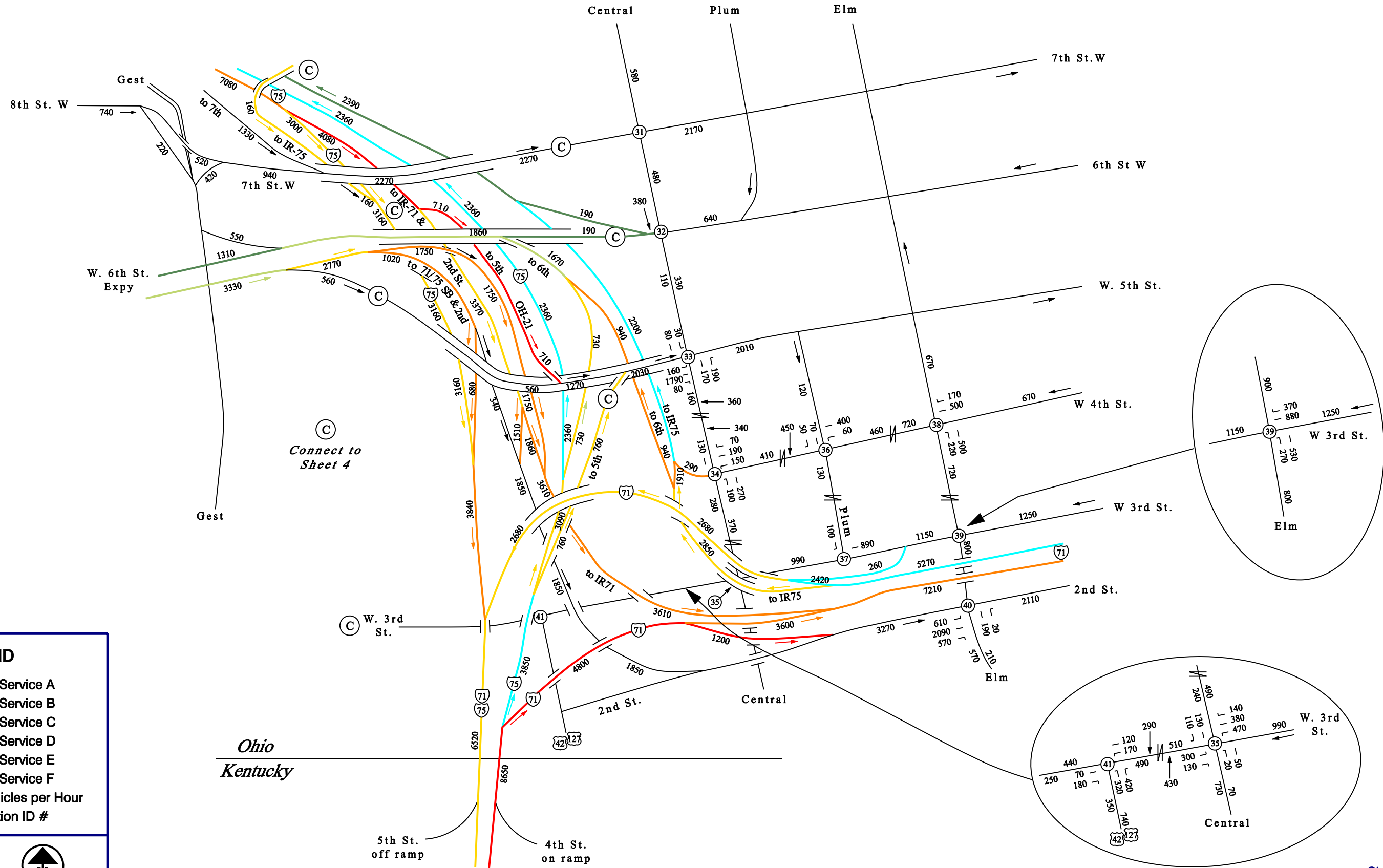

**LEGEND**

- Level of Service A
- Level of Service B
- Level of Service C
- Level of Service D
- Level of Service E
- Level of Service F
- 2569 # of Vehicles per Hour
- (12) Intersection ID #

NOT TO SCALE



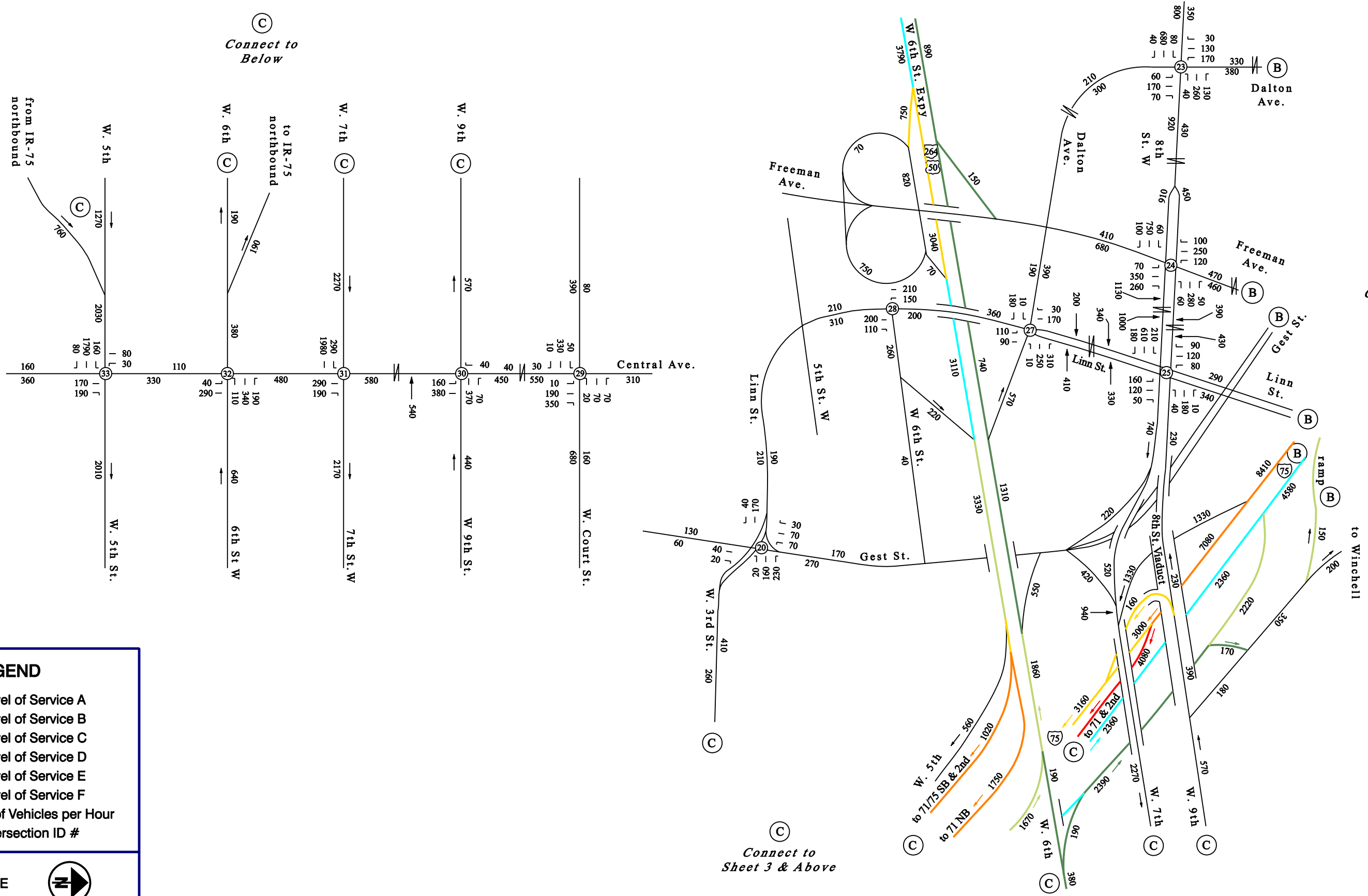

ⓐ  
Connect to  
Below

ⓑ  
Connect to  
Sheet 5

ⓐ  
Connect to  
Sheet 3 & Above

**LEGEND**

- Level of Service A
- Level of Service B
- Level of Service C
- Level of Service D
- Level of Service E
- Level of Service F
- 2569 # of Vehicles per Hour
- ⓐ Intersection ID #

NOT TO SCALE





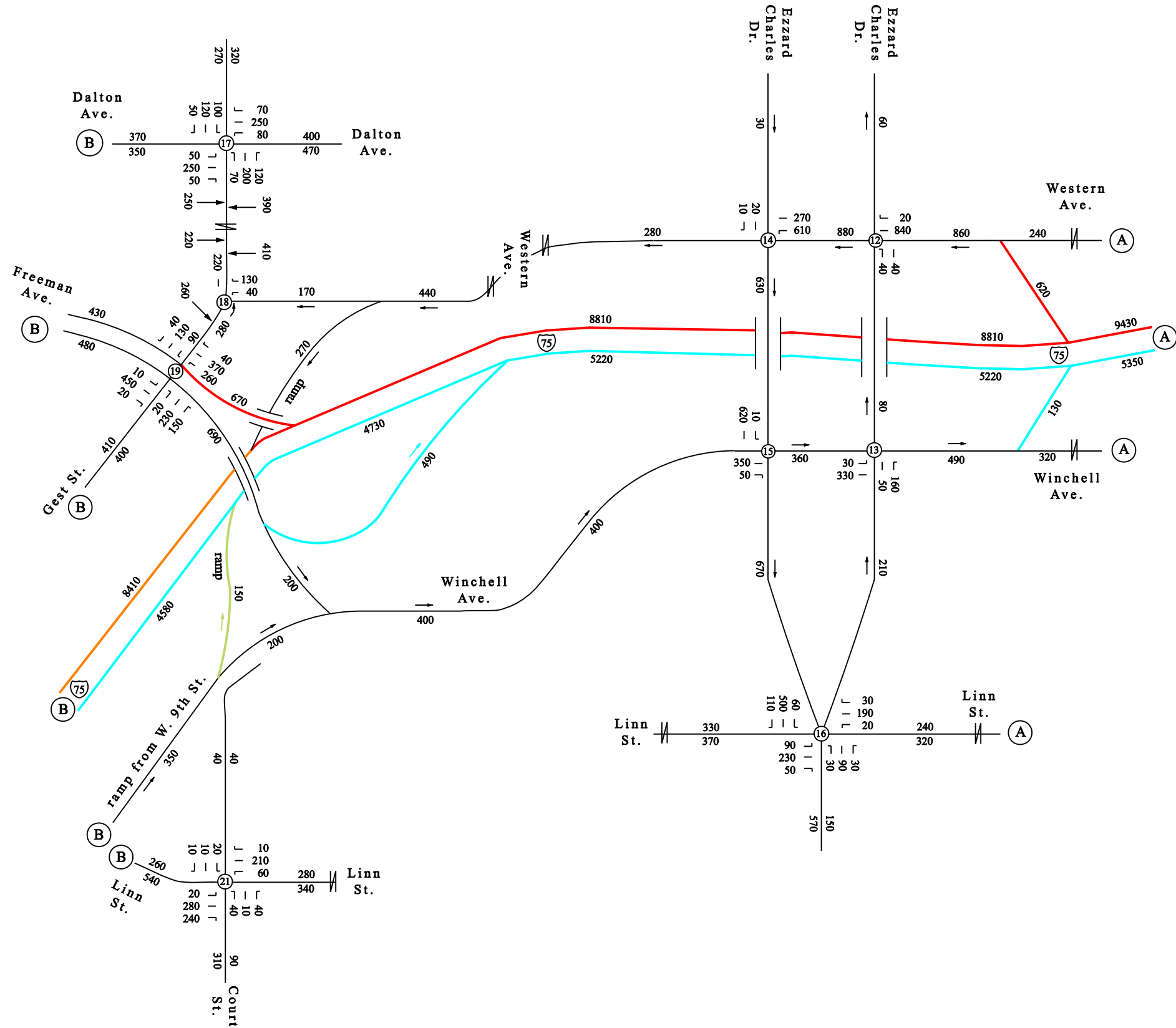

(B)  
Connect to  
Sheet 4

(A)  
Connect to  
Sheet 6

**LEGEND**

- Level of Service A
- Level of Service B
- Level of Service C
- Level of Service D
- Level of Service E
- Level of Service F
- 2569 # of Vehicles per Hour
- (12) Intersection ID #

NOT TO SCALE



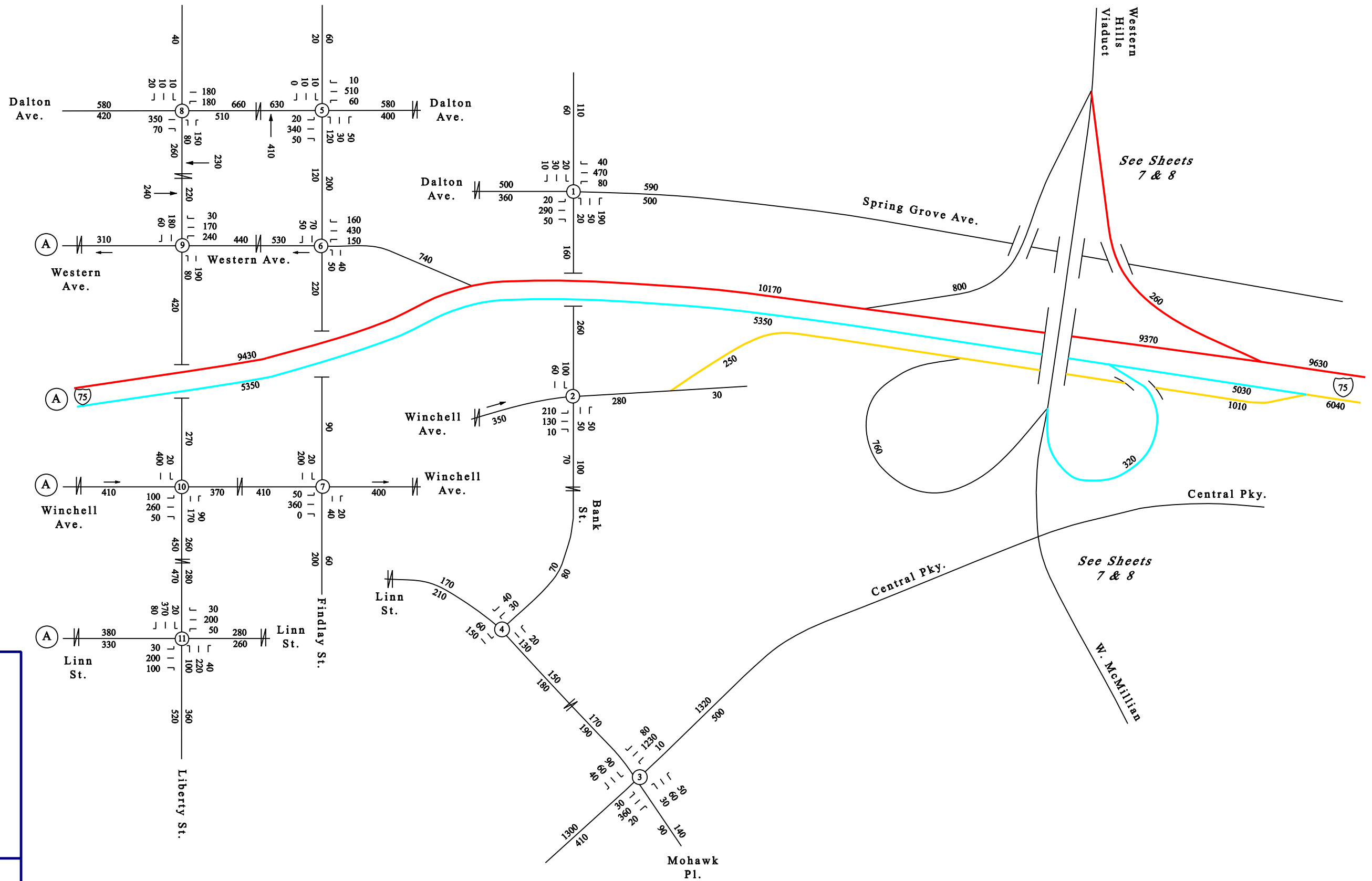

Ⓐ  
Connect to  
Sheet 5

See Sheets  
7 & 8

See Sheets  
7 & 8

**LEGEND**

- Level of Service A
- Level of Service B
- Level of Service C
- Level of Service D
- Level of Service E
- Level of Service F
- 2569 # of Vehicles per Hour
- Ⓐ Intersection ID #

NOT TO SCALE



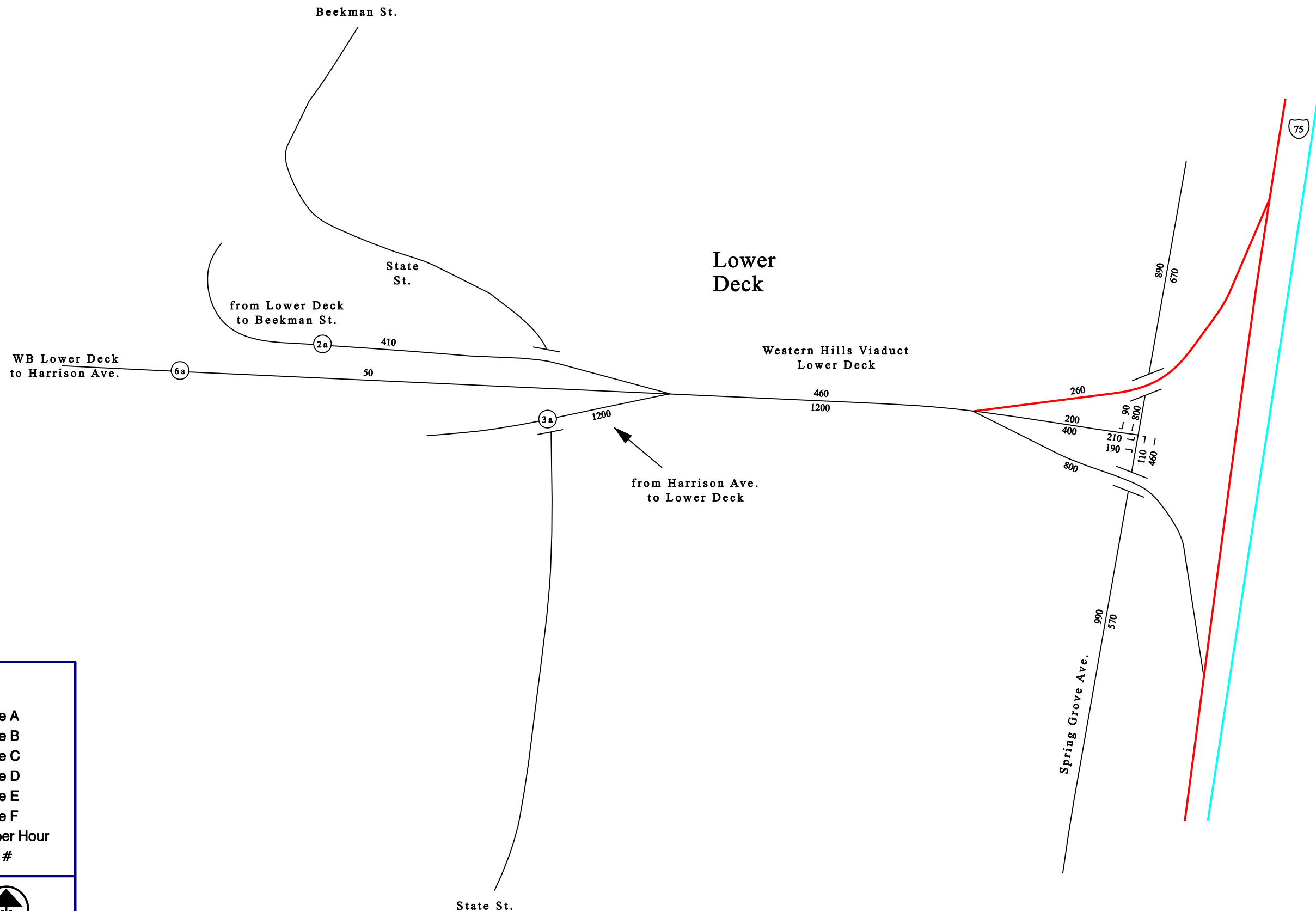

**LEGEND**

- Level of Service A
- Level of Service B
- Level of Service C
- Level of Service D
- Level of Service E
- Level of Service F
- 2569 # of Vehicles per Hour
- (12) Intersection ID #

NOT TO SCALE



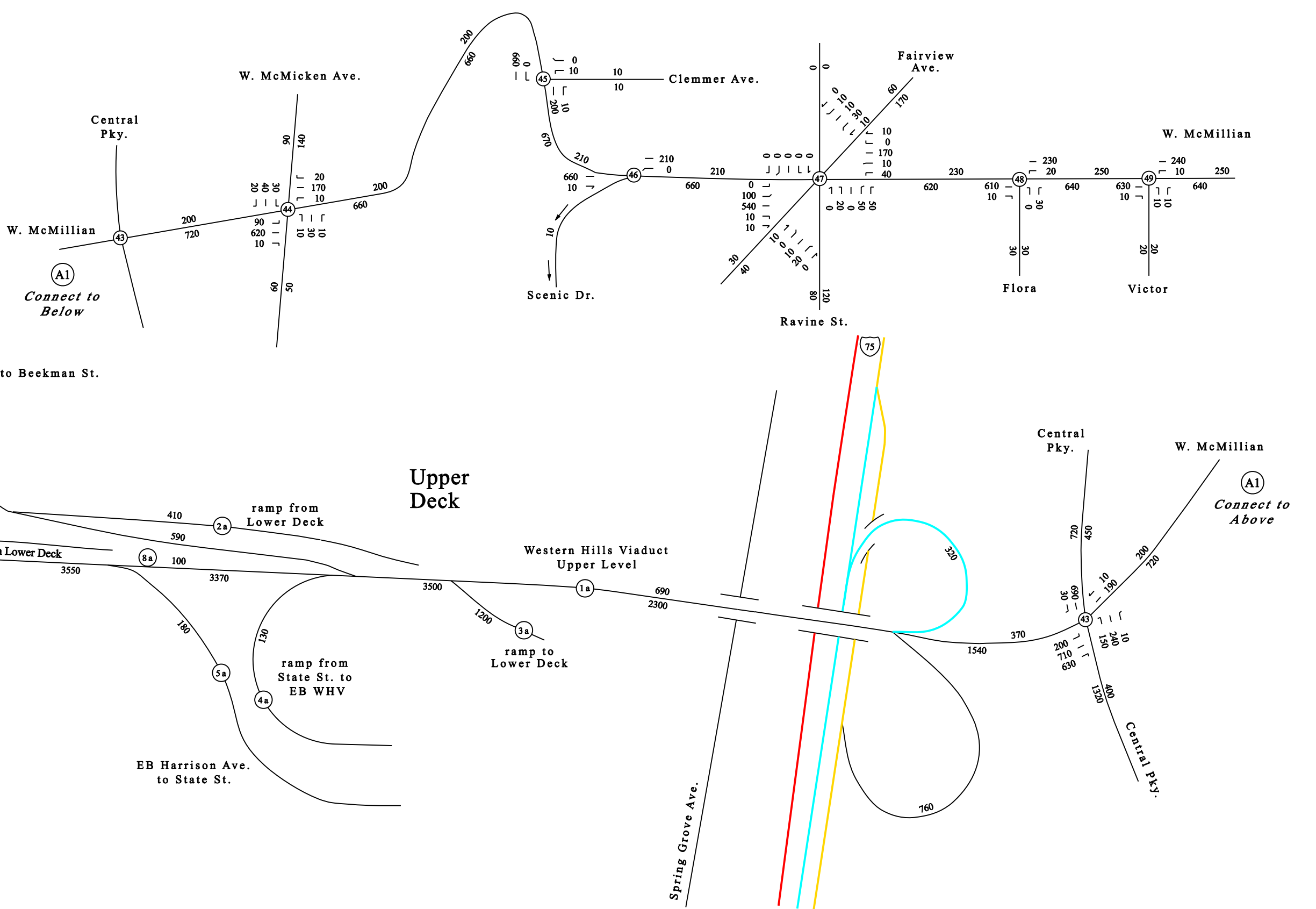

**LEGEND**

- Level of Service A
- Level of Service B
- Level of Service C
- Level of Service D
- Level of Service E
- Level of Service F
- 2569 # of Vehicles per Hour
- (12) Intersection ID #

NOT TO SCALE



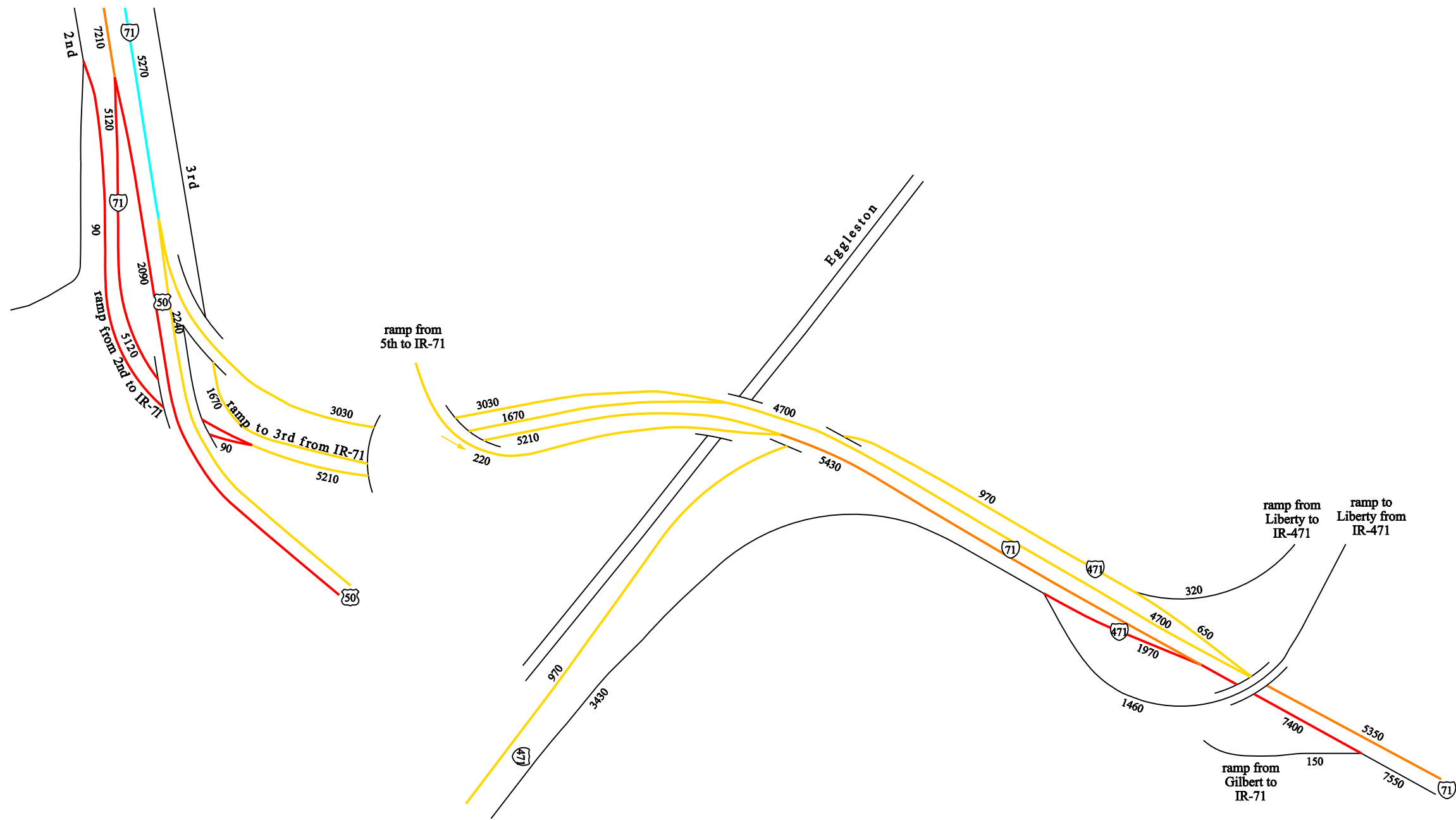

**LEGEND**

- Level of Service A
  - Level of Service B
  - Level of Service C
  - Level of Service D
  - Level of Service E
  - Level of Service F
- 2569 # of Vehicles per Hour  
 (12) Intersection ID #

NOT TO SCALE



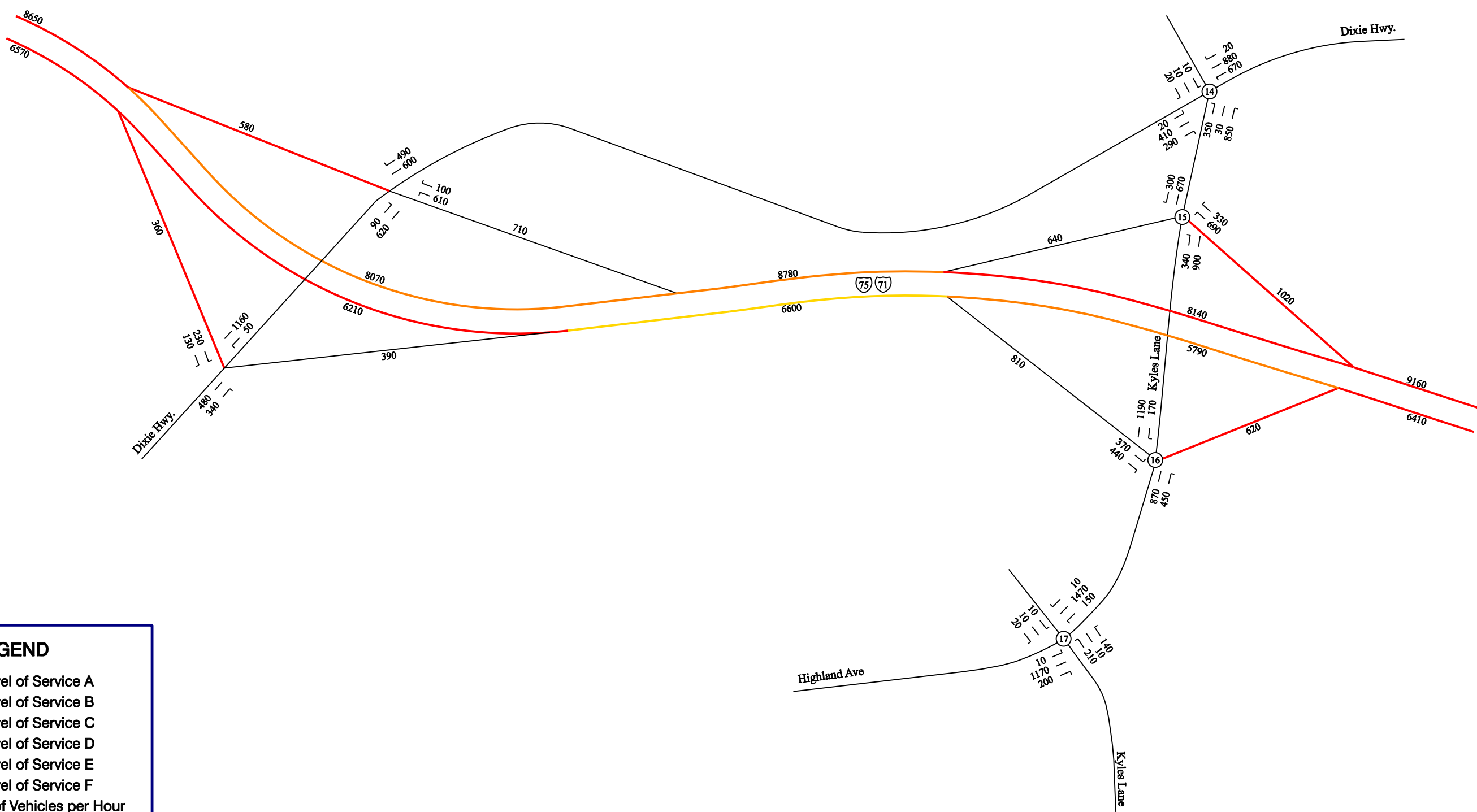

**LEGEND**

- Level of Service A
- Level of Service B
- Level of Service C
- Level of Service D
- Level of Service E
- Level of Service F
- 2569 # of Vehicles per Hour
- (12) Intersection ID #

NOT TO SCALE



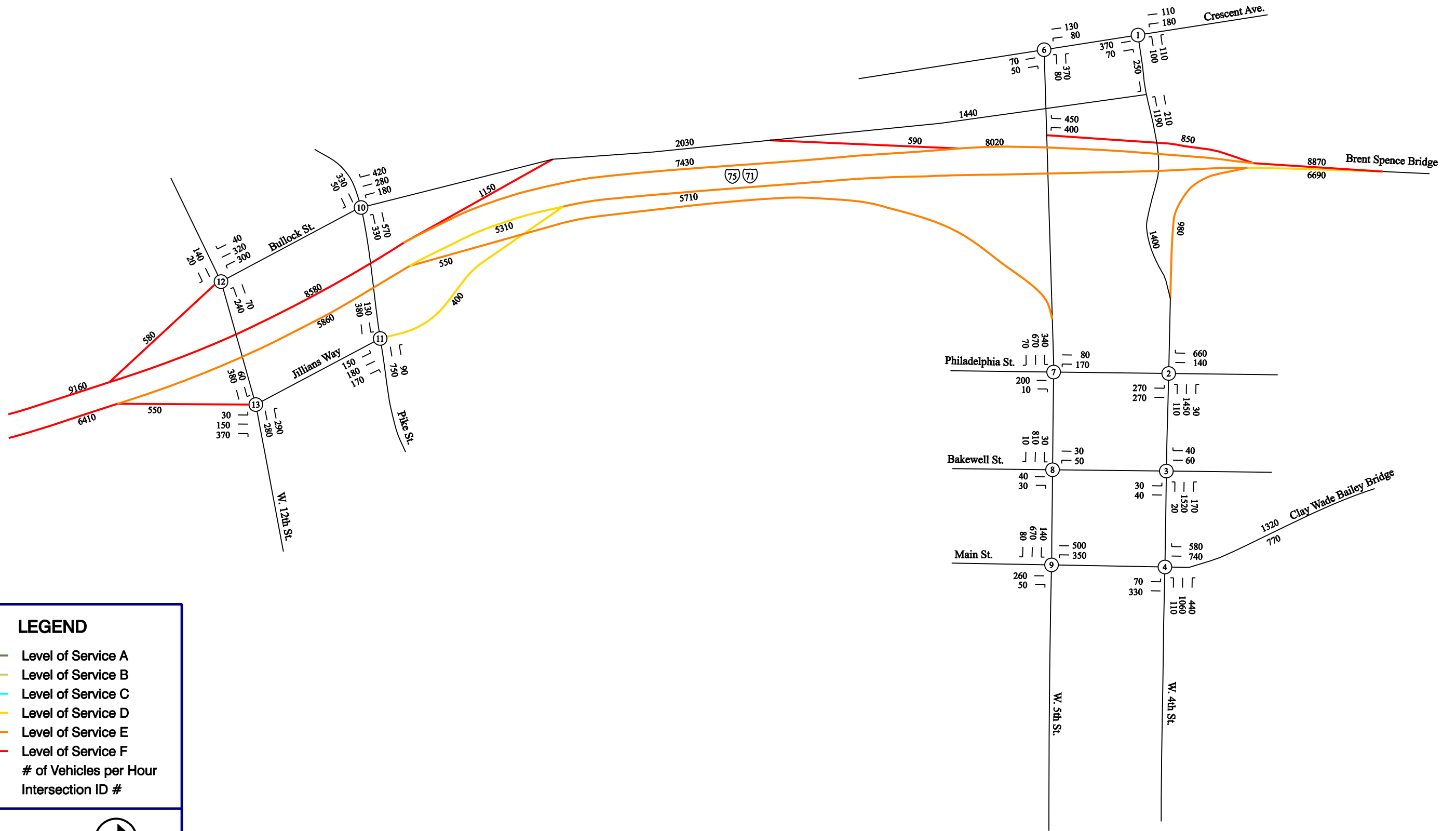

**LEGEND**

- Level of Service A
- Level of Service B
- Level of Service C
- Level of Service D
- Level of Service E
- Level of Service F
- 2569 # of Vehicles per Hour
- (12) Intersection ID #

NOT TO SCALE



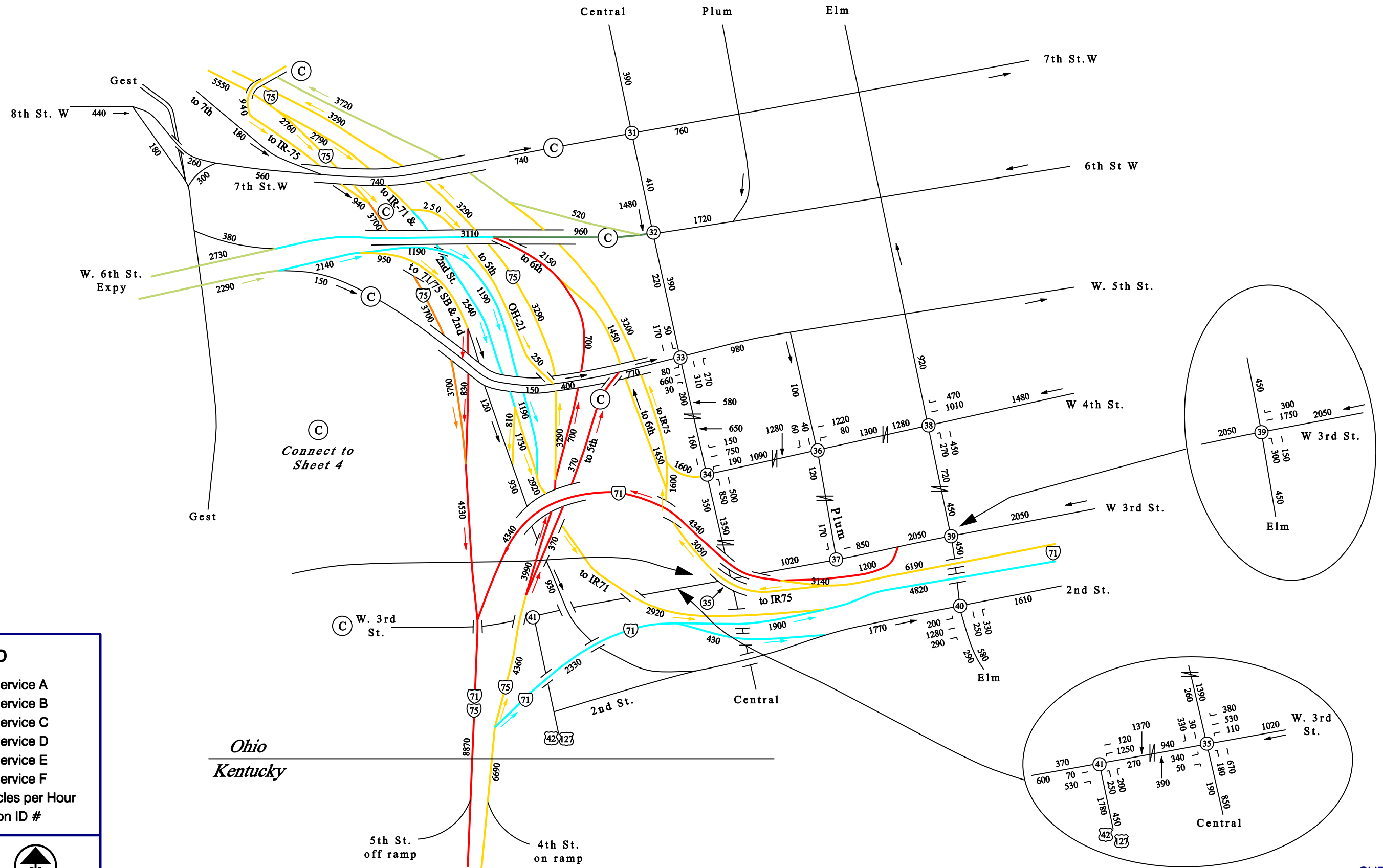

**LEGEND**

- Level of Service A
- Level of Service B
- Level of Service C
- Level of Service D
- Level of Service E
- Level of Service F
- 2569 # of Vehicles per Hour
- (12) Intersection ID #

NOT TO SCALE





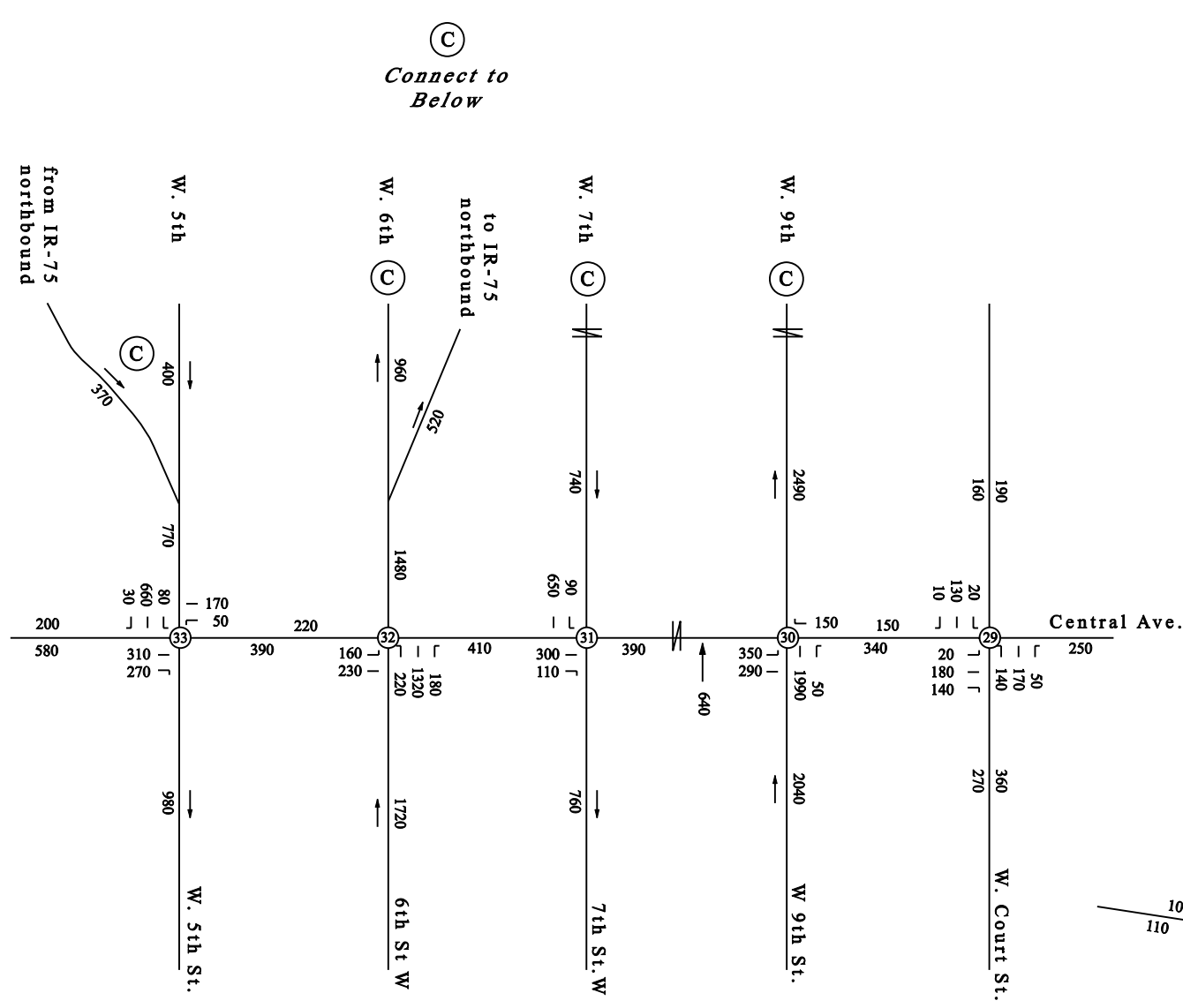

Connect to Below

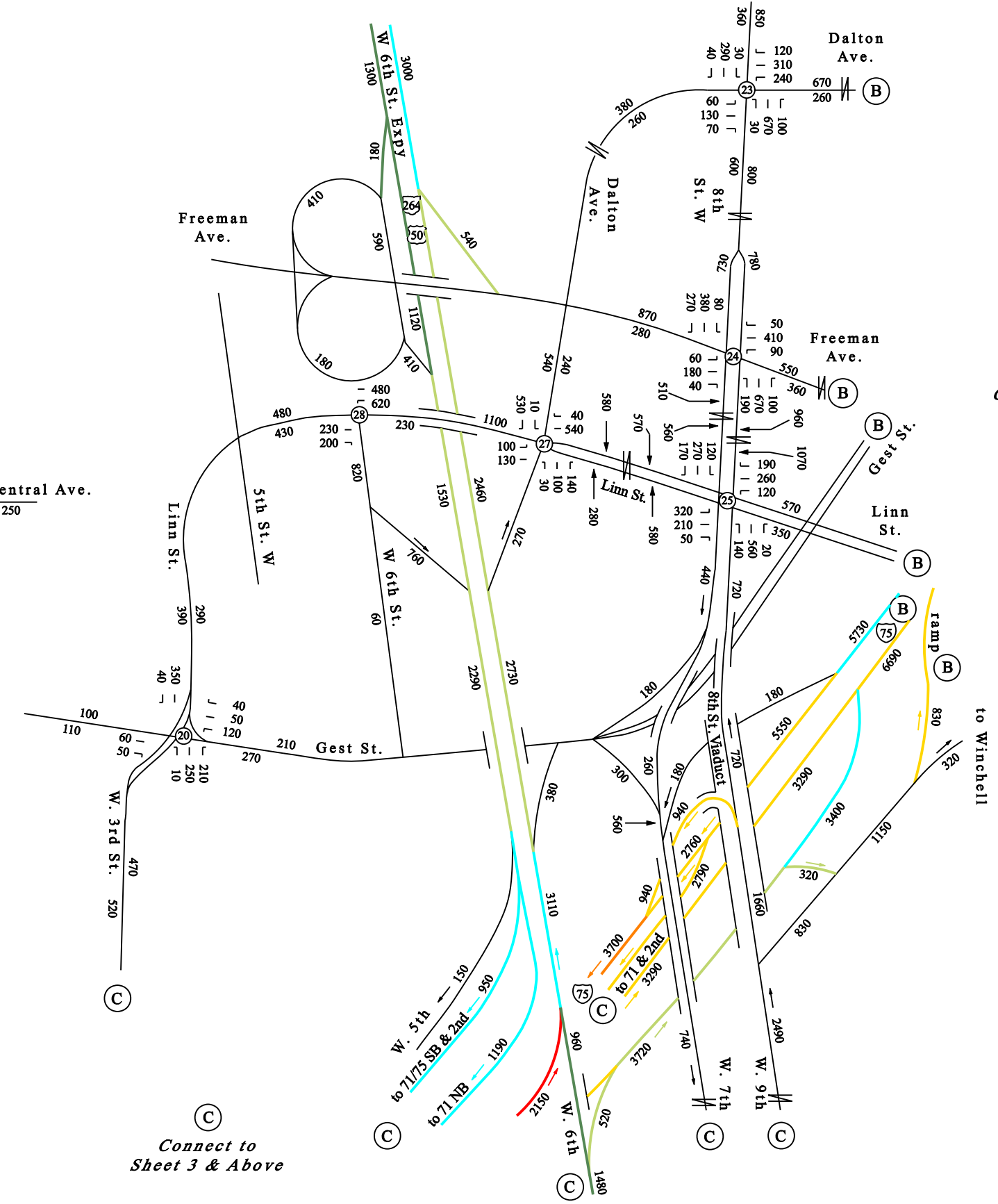

Connect to Sheet 5

Connect to Sheet 3 & Above

**LEGEND**

- Level of Service A
- Level of Service B
- Level of Service C
- Level of Service D
- Level of Service E
- Level of Service F
- 2569 # of Vehicles per Hour
- (12) Intersection ID #

NOT TO SCALE



**2035 PM LEVEL OF SERVICE  
NO BUILD ALTERNATIVE  
(OHIO)**

SHEET  
(4 OF 9)  
**EXHIBIT  
A2-D**

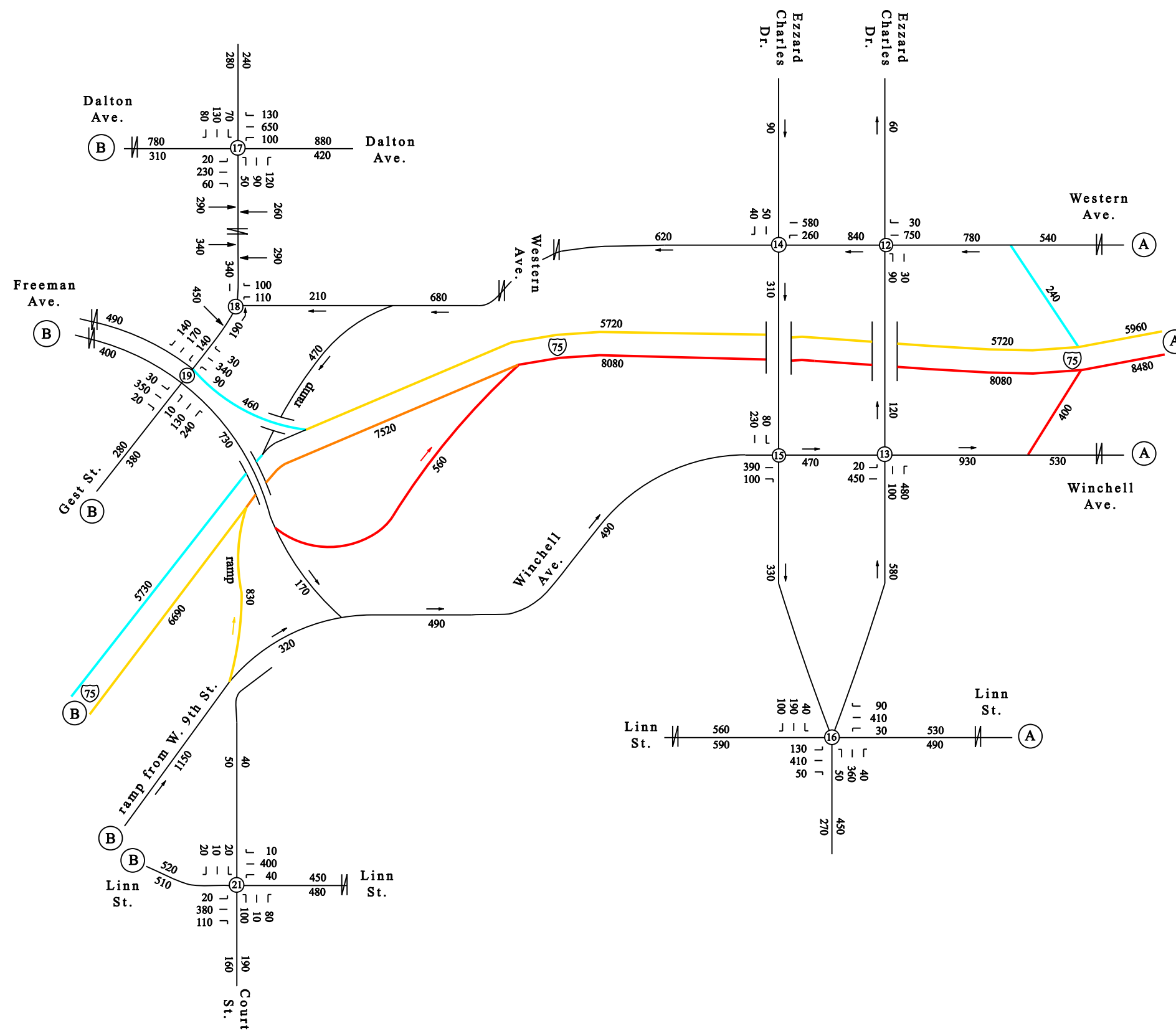

(B) Connect to Sheet 4

(A) Connect to Sheet 6

**LEGEND**

- Level of Service A
- Level of Service B
- Level of Service C
- Level of Service D
- Level of Service E
- Level of Service F
- 2569 # of Vehicles per Hour
- (12) Intersection ID #

NOT TO SCALE



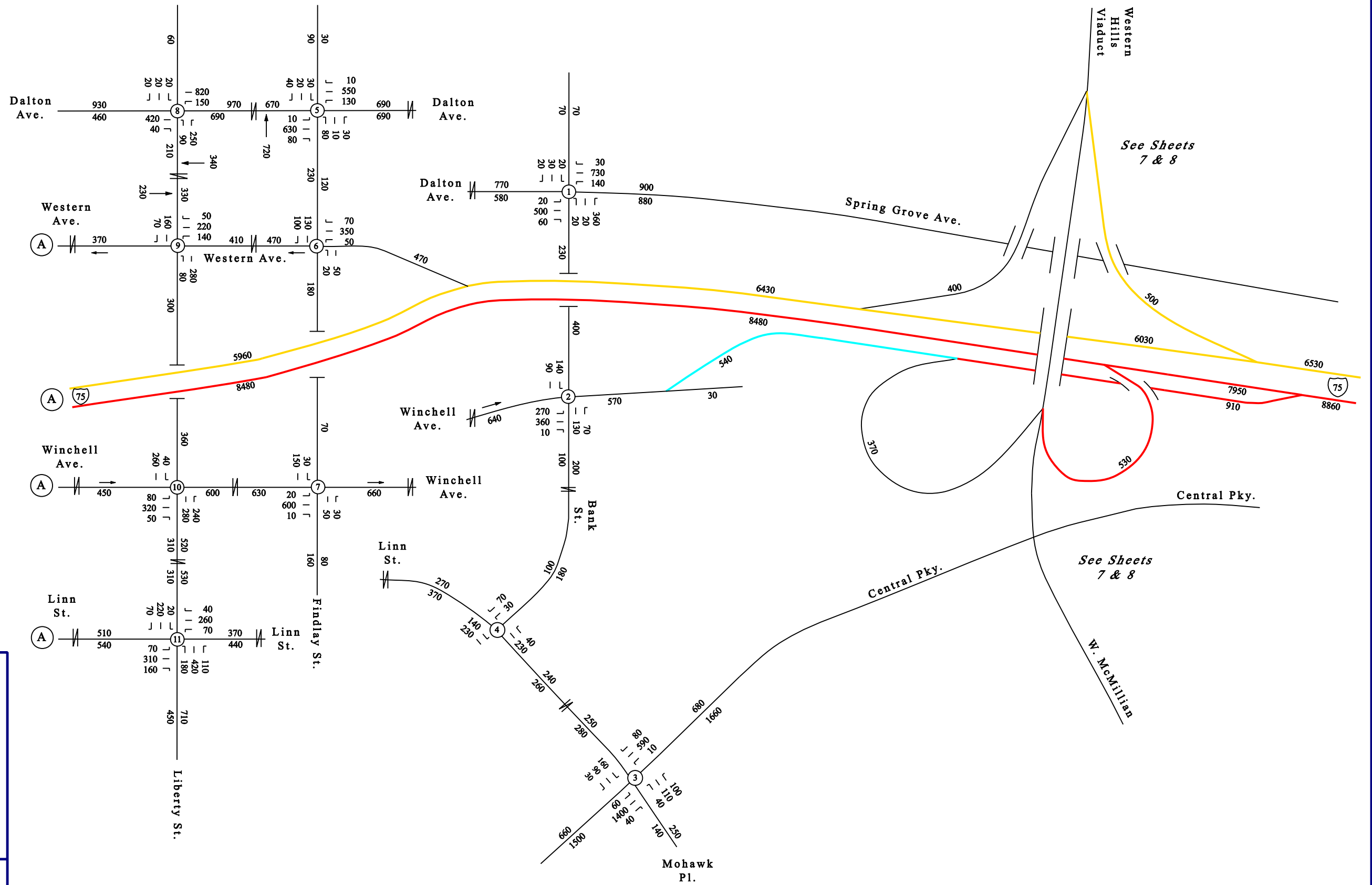

(A)  
Connect to  
Sheet 5

**LEGEND**

- Level of Service A
- Level of Service B
- Level of Service C
- Level of Service D
- Level of Service E
- Level of Service F
- 2569 # of Vehicles per Hour
- (12) Intersection ID #

NOT TO SCALE



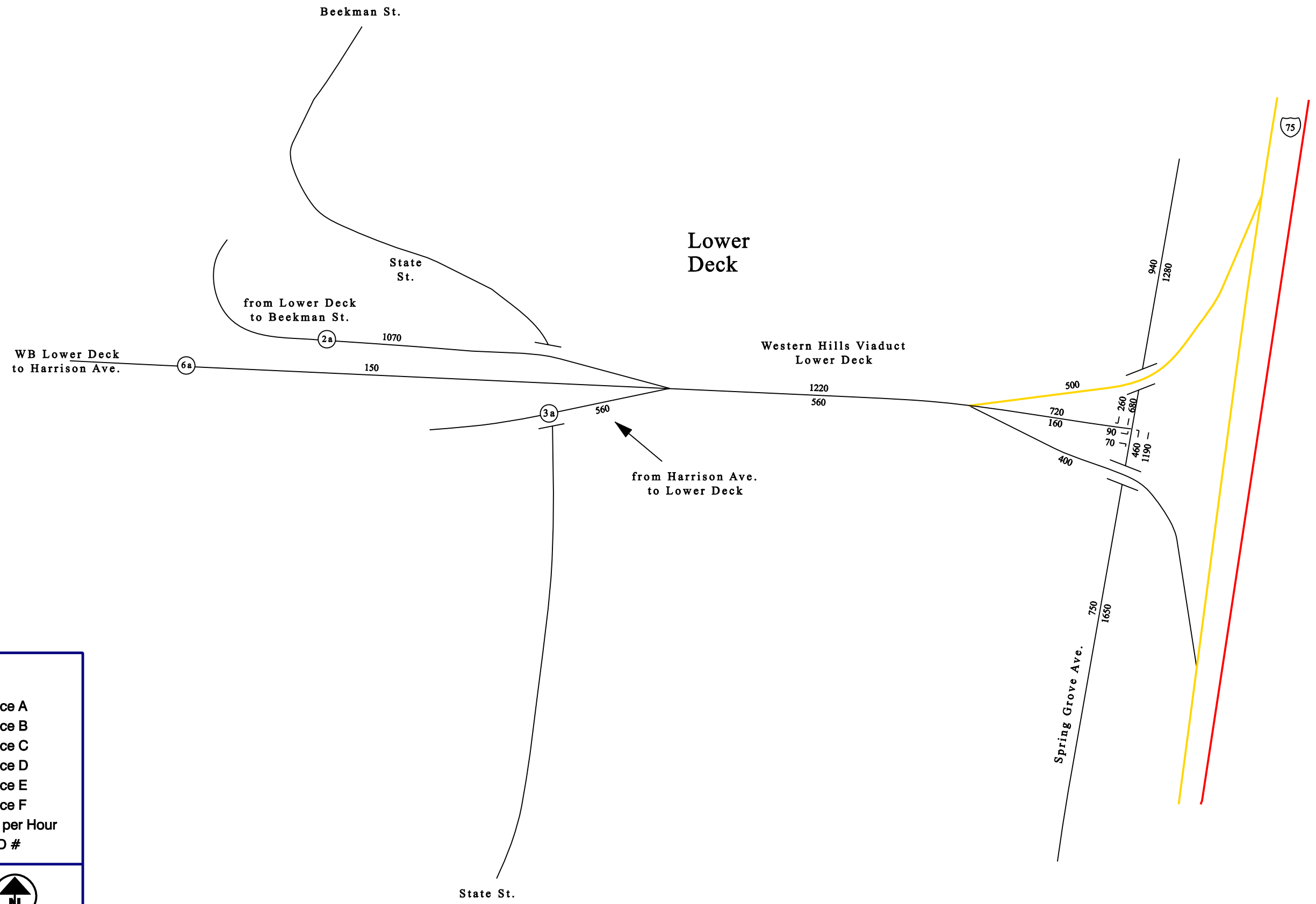

**LEGEND**

- Level of Service A
- Level of Service B
- Level of Service C
- Level of Service D
- Level of Service E
- Level of Service F
- 2569 # of Vehicles per Hour
- (12) Intersection ID #

NOT TO SCALE



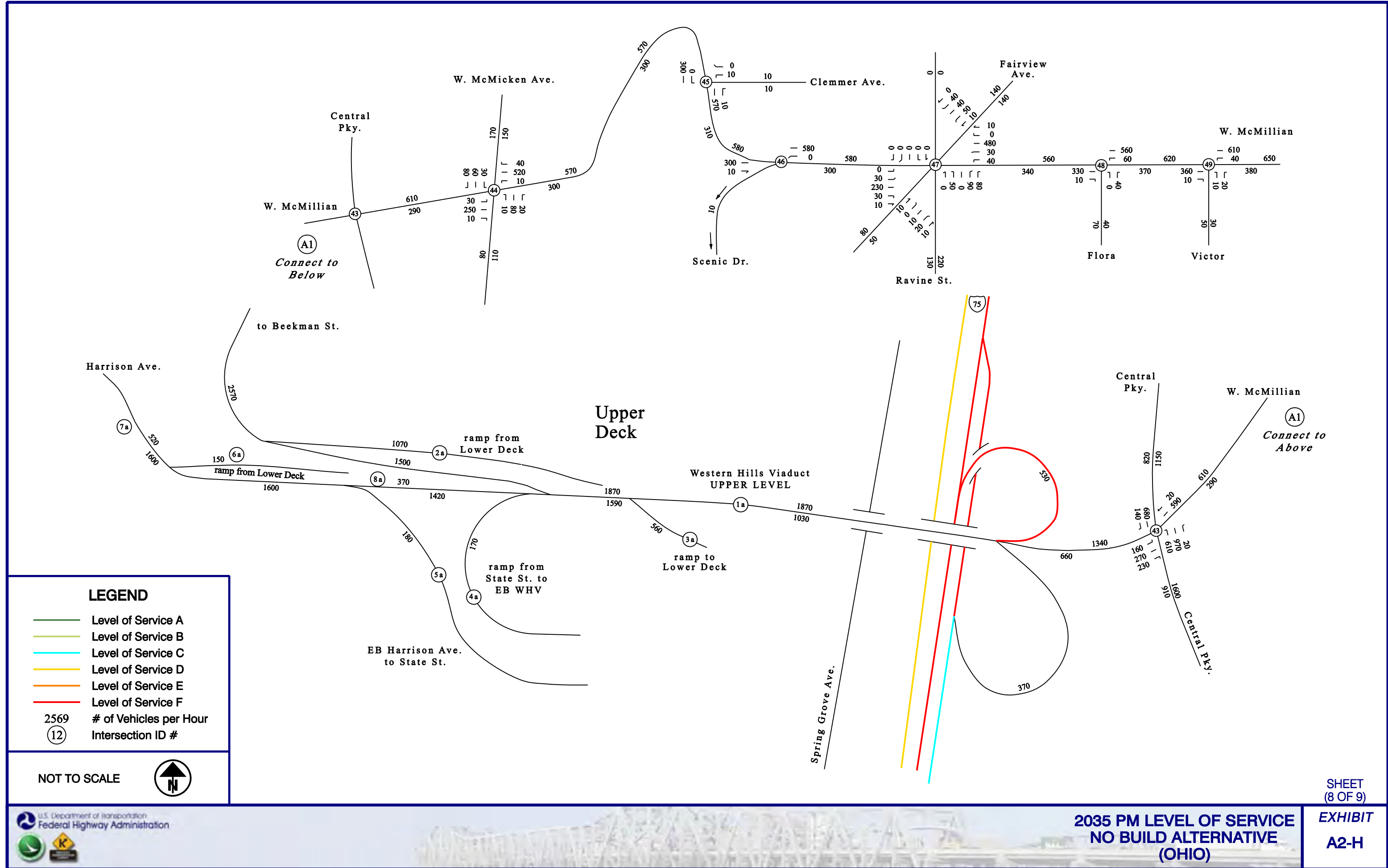

**LEGEND**

- Level of Service A
- Level of Service B
- Level of Service C
- Level of Service D
- Level of Service E
- Level of Service F
- 2569 # of Vehicles per Hour
- (12) Intersection ID #

NOT TO SCALE



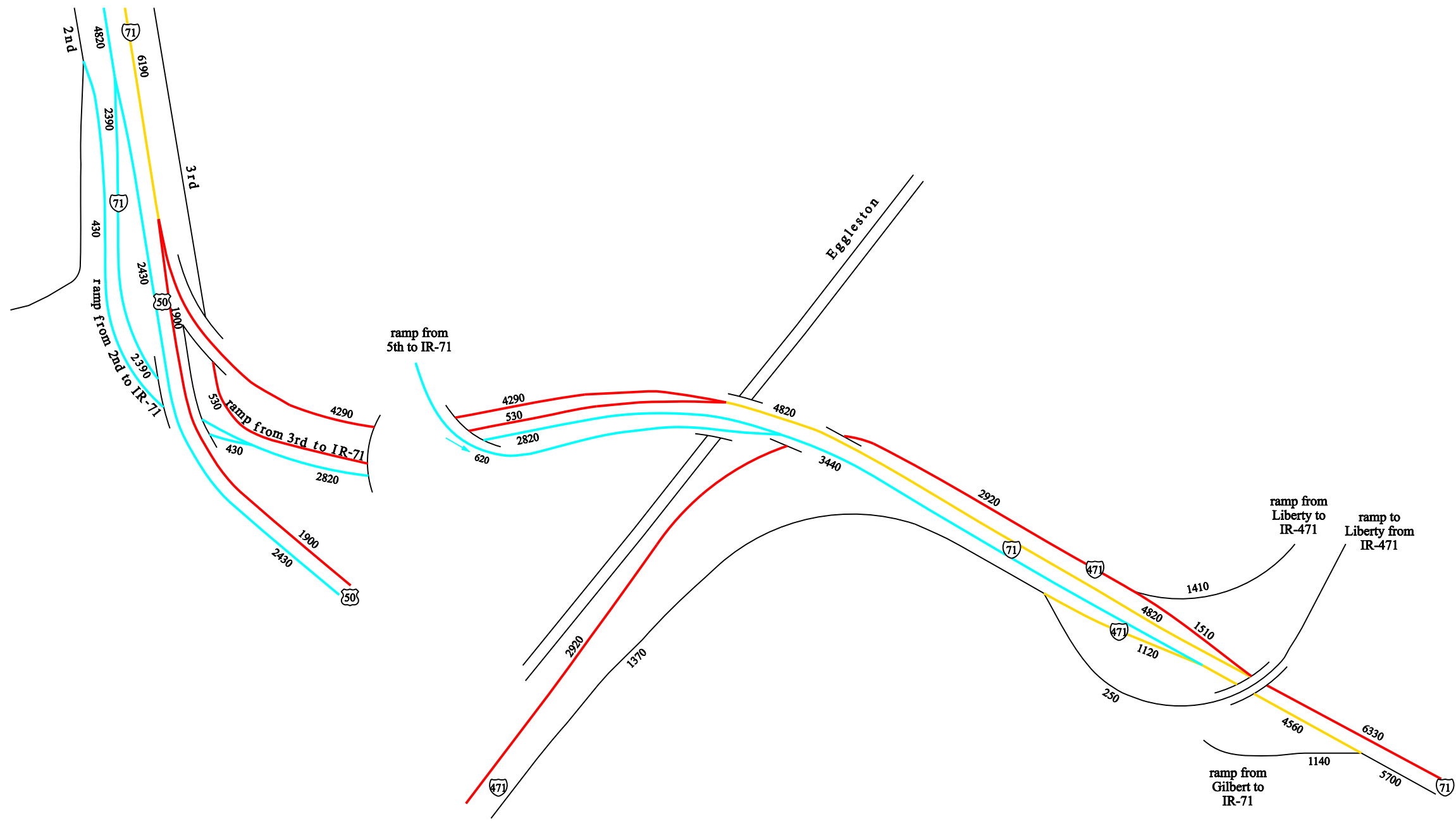

**LEGEND**

- Level of Service A
- Level of Service B
- Level of Service C
- Level of Service D
- Level of Service E
- Level of Service F
- 2569 # of Vehicles per Hour
- (12) Intersection ID #

NOT TO SCALE



# **Appendix B**

## **Typical Sections**

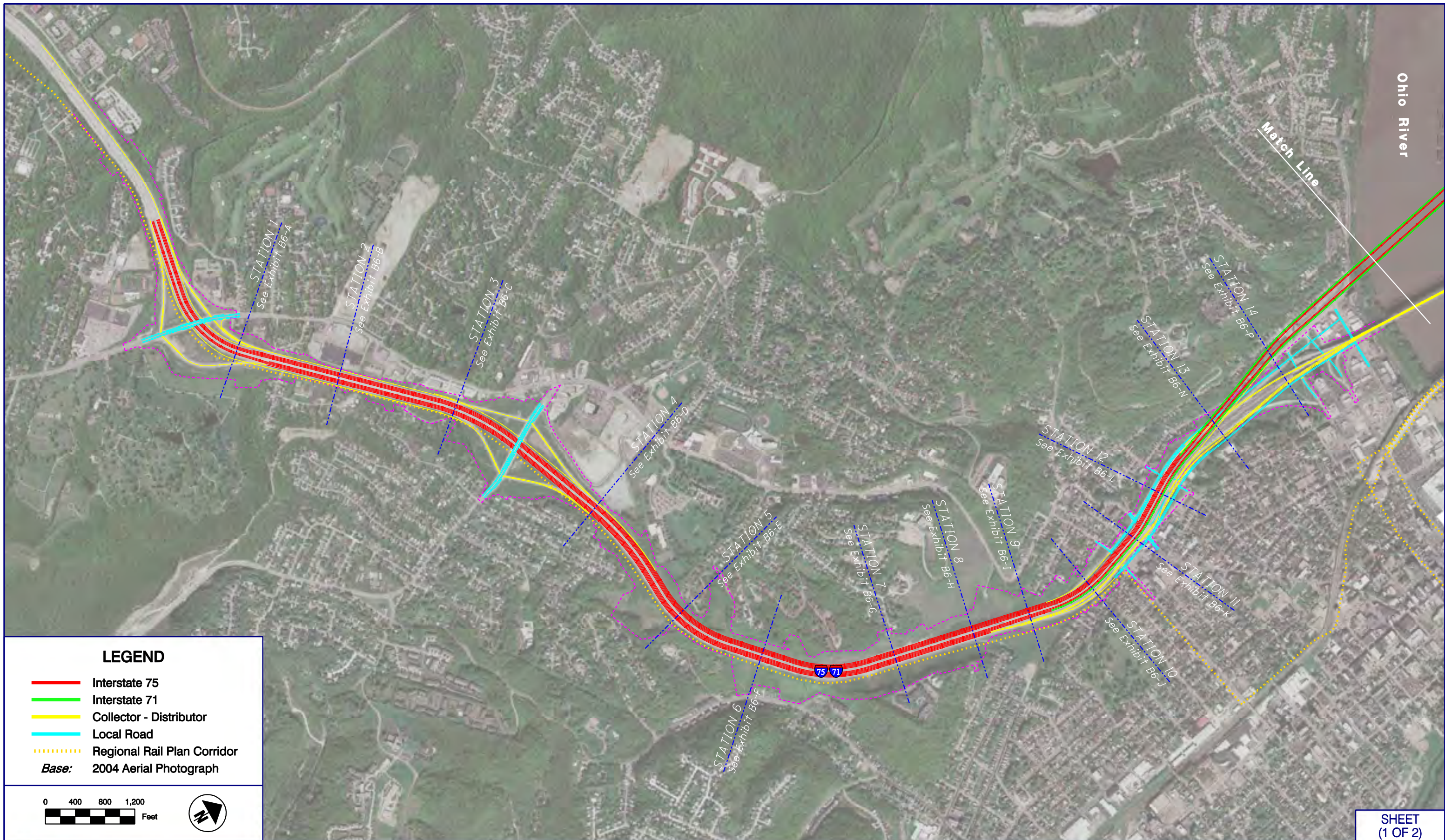

Ohio River

Match Line

**LEGEND**

- Interstate 75
- Interstate 71
- Collector - Distributor
- Local Road
- Regional Rail Plan Corridor
- Base:* 2004 Aerial Photograph

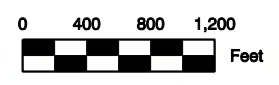

**CRITICAL CROSS SECTIONS PLAN  
ALTERNATIVE B (KENTUCKY)**

SHEET  
(1 OF 2)

**EXHIBIT  
B1-A**



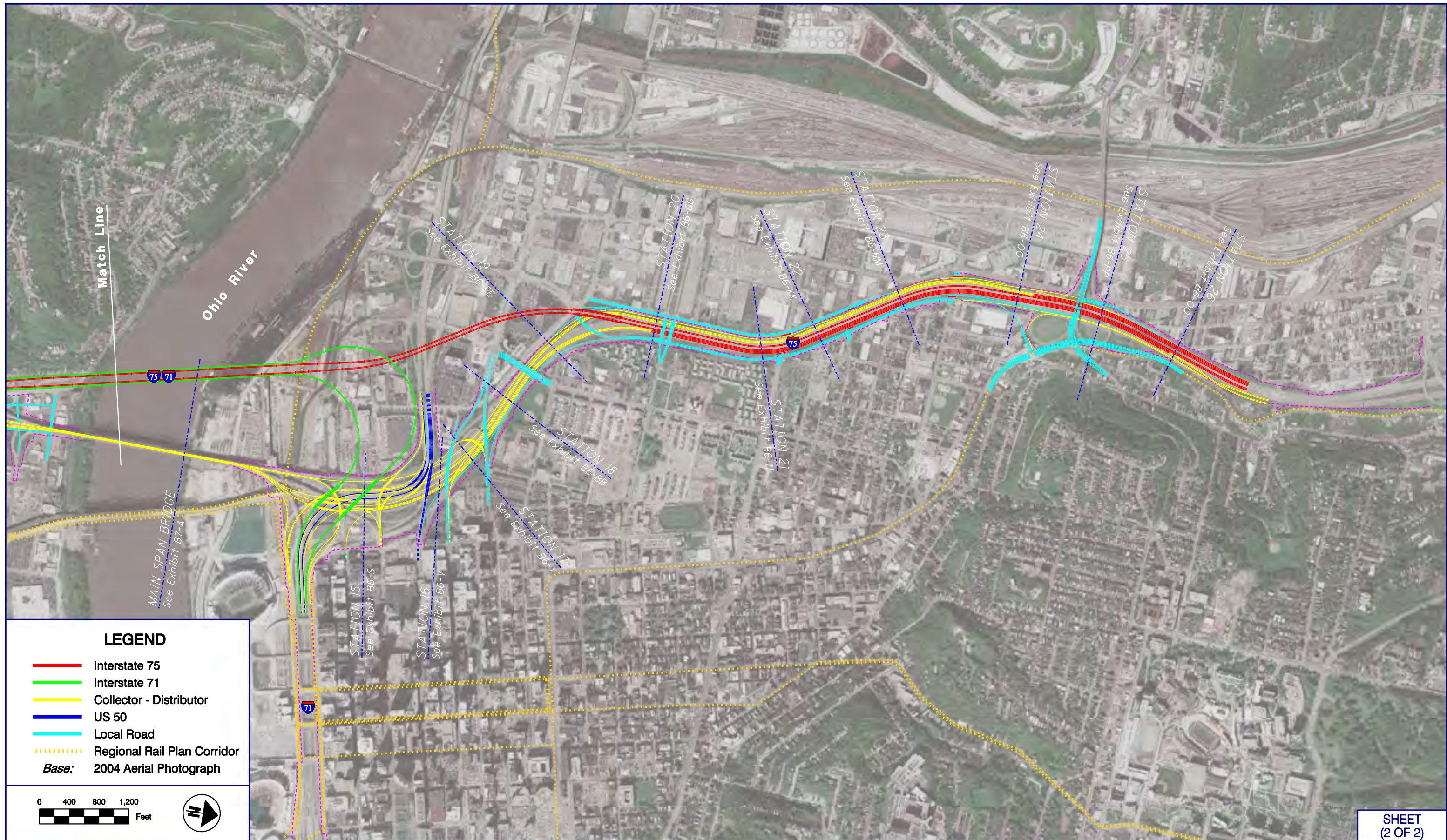

**LEGEND**

- Interstate 75
  - Interstate 71
  - Collector - Distributor
  - US 50
  - Local Road
  - Regional Rail Plan Corridor
- Base:* 2004 Aerial Photograph

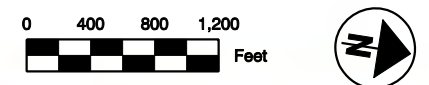

**CRITICAL CROSS  
SECTIONS PLAN  
ALTERNATIVE B (OHIO)**

SHEET  
(2 OF 2)  
**EXHIBIT  
B1-B**

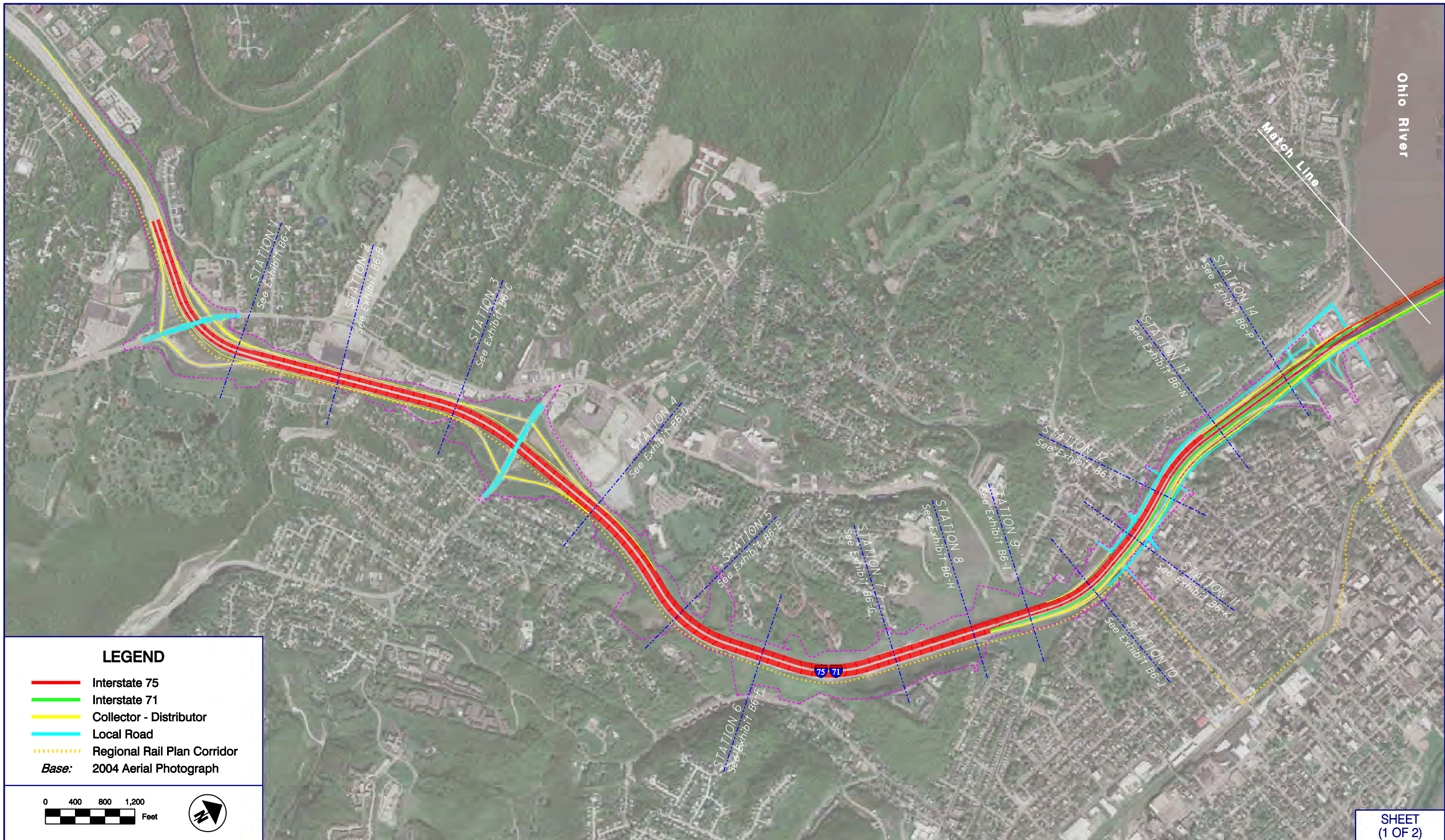

Ohio River

Match Line

STATION 1  
See Exhibit B6-A

STATION 2  
See Exhibit B6-B

STATION 3  
See Exhibit B6-C

STATION 4  
See Exhibit B6-D

STATION 5  
See Exhibit B6-E

STATION 6  
See Exhibit B6-F

STATION 7  
See Exhibit B6-G

STATION 8  
See Exhibit B6-H

STATION 9  
See Exhibit B6-I

STATION 10  
See Exhibit B6-J

STATION 11  
See Exhibit B6-K

STATION 12  
See Exhibit B6-L

STATION 13  
See Exhibit B6-M

STATION 14  
See Exhibit B6-P

**LEGEND**

- Interstate 75
  - Interstate 71
  - Collector - Distributor
  - Local Road
  - - - Regional Rail Plan Corridor
- Base:* 2004 Aerial Photograph

0 400 800 1,200  
Feet



**CRITICAL CROSS  
SECTIONS PLAN  
ALTERNATIVE C (KENTUCKY)**

SHEET  
(1 OF 2)

**EXHIBIT  
B2-A**

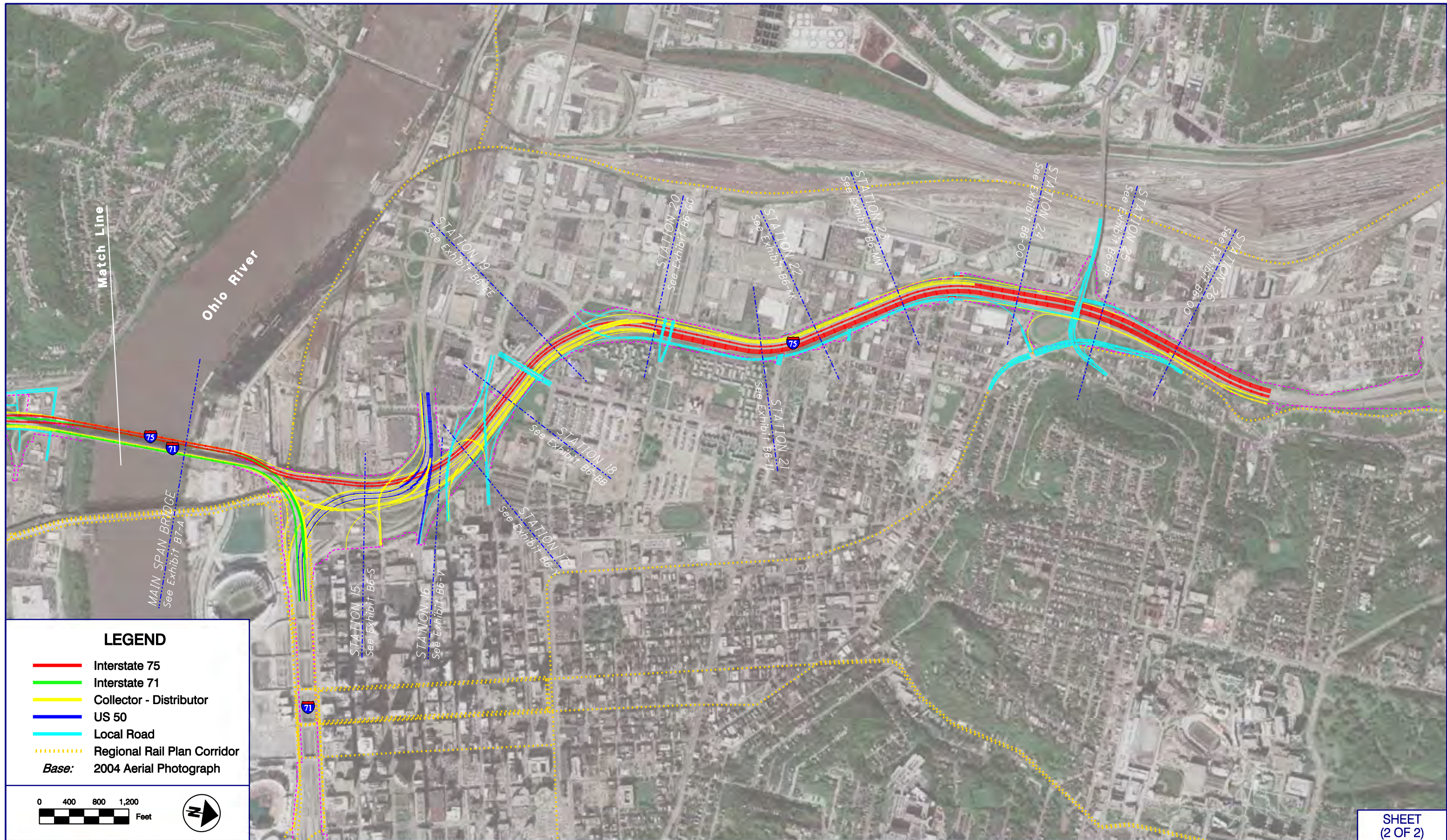

**LEGEND**

- Interstate 75
  - Interstate 71
  - Collector - Distributor
  - US 50
  - Local Road
  - Regional Rail Plan Corridor
- Base:* 2004 Aerial Photograph

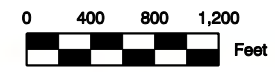

U.S. Department of Transportation  
Federal Highway Administration



Prepared by  
**PARSONS**  
BRINCKERHOFF

**CRITICAL CROSS  
SECTIONS PLAN  
ALTERNATIVE C (OHIO)**

SHEET  
(2 OF 2)

**EXHIBIT  
B2-B**

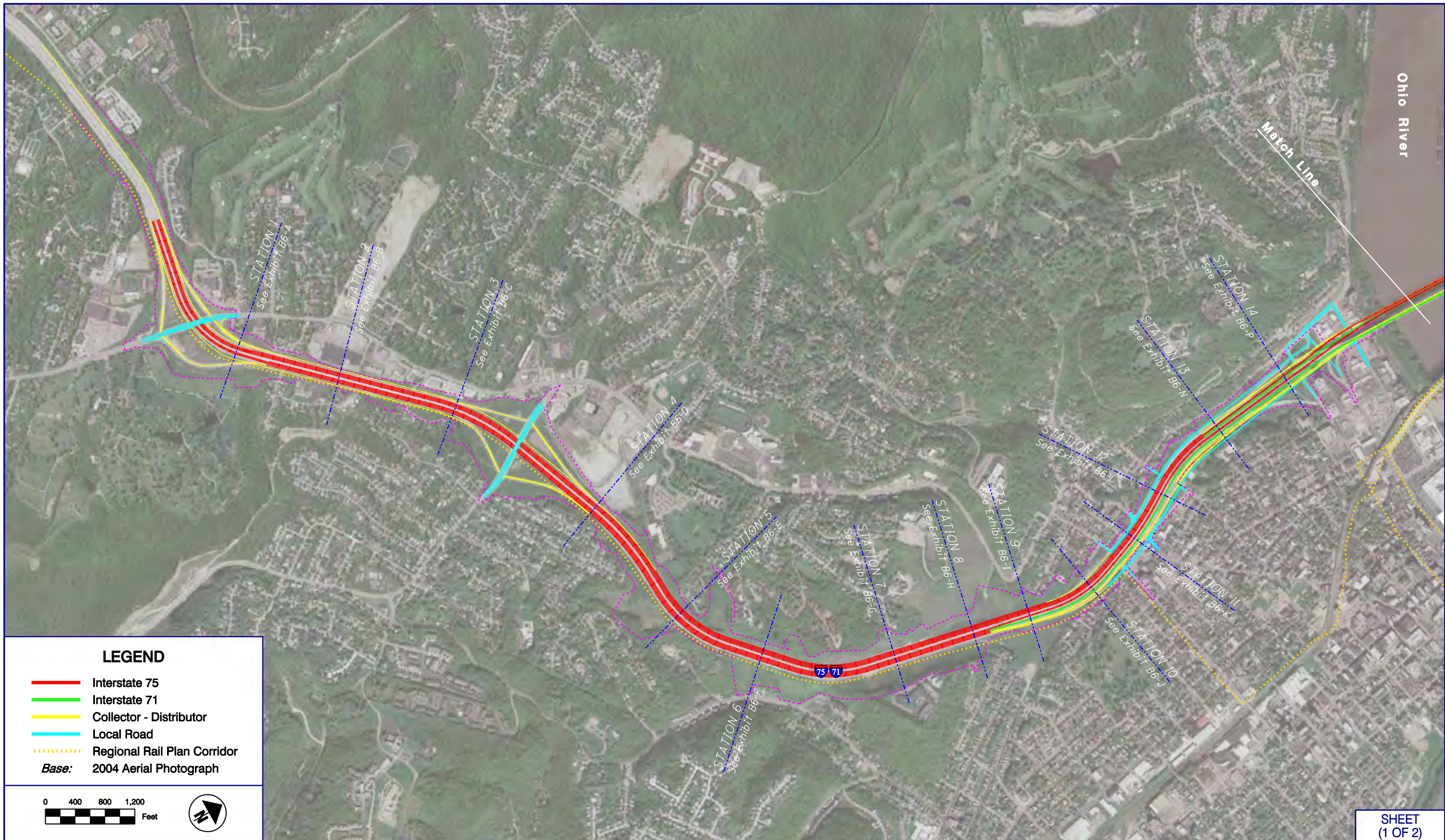

Ohio River

Match Line

STATION 1  
See Exhibit B6-A

STATION 2  
See Exhibit B6-B

STATION 3  
See Exhibit B6-C

STATION 4  
See Exhibit B6-D

STATION 5  
See Exhibit B6-E

STATION 6  
See Exhibit B6-F

STATION 7  
See Exhibit B6-G

STATION 8  
See Exhibit B6-H

STATION 9  
See Exhibit B6-I

STATION 10  
See Exhibit B6-J

STATION 11  
See Exhibit B6-K

STATION 12  
See Exhibit B6-L

STATION 13  
See Exhibit B6-M

STATION 14  
See Exhibit B6-P

**LEGEND**

- Interstate 75
  - Interstate 71
  - Collector - Distributor
  - Local Road
  - - - - - Regional Rail Plan Corridor
- Base:* 2004 Aerial Photograph

0 400 800 1,200  
Feet

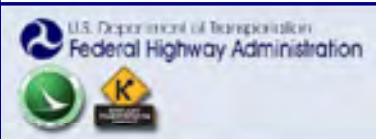

**CRITICAL CROSS SECTIONS PLAN  
ALTERNATIVE D (KENTUCKY)**

SHEET  
(1 OF 2)

**EXHIBIT  
B3-A**

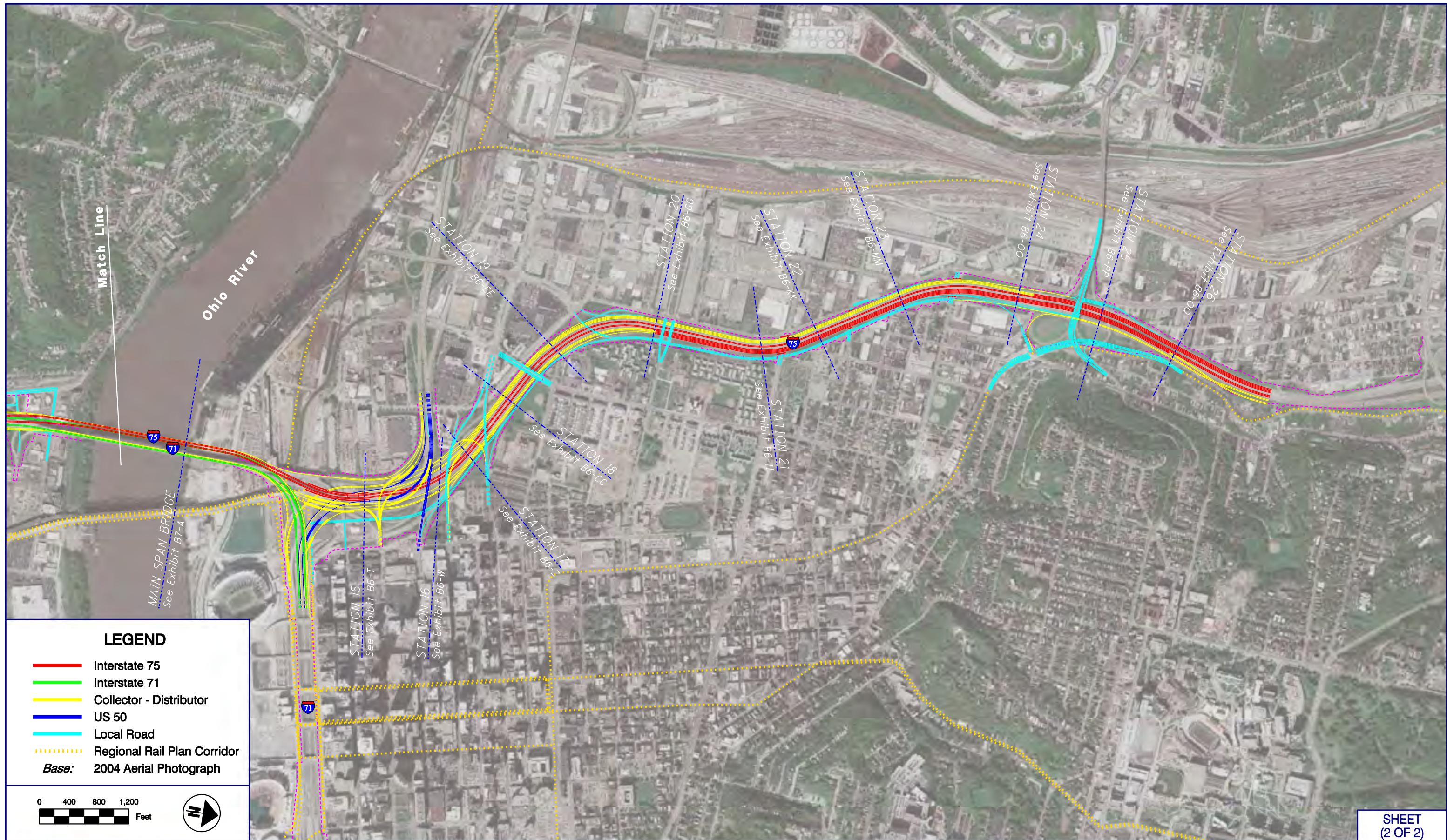

**LEGEND**

- Interstate 75
  - Interstate 71
  - Collector - Distributor
  - US 50
  - Local Road
  - Regional Rail Plan Corridor
- Base:* 2004 Aerial Photograph

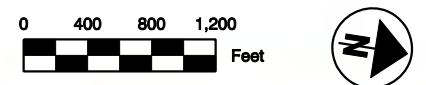

**CRITICAL CROSS SECTIONS PLAN  
ALTERNATIVE D (OHIO)**

SHEET  
(2 OF 2)  
**EXHIBIT  
B3-B**

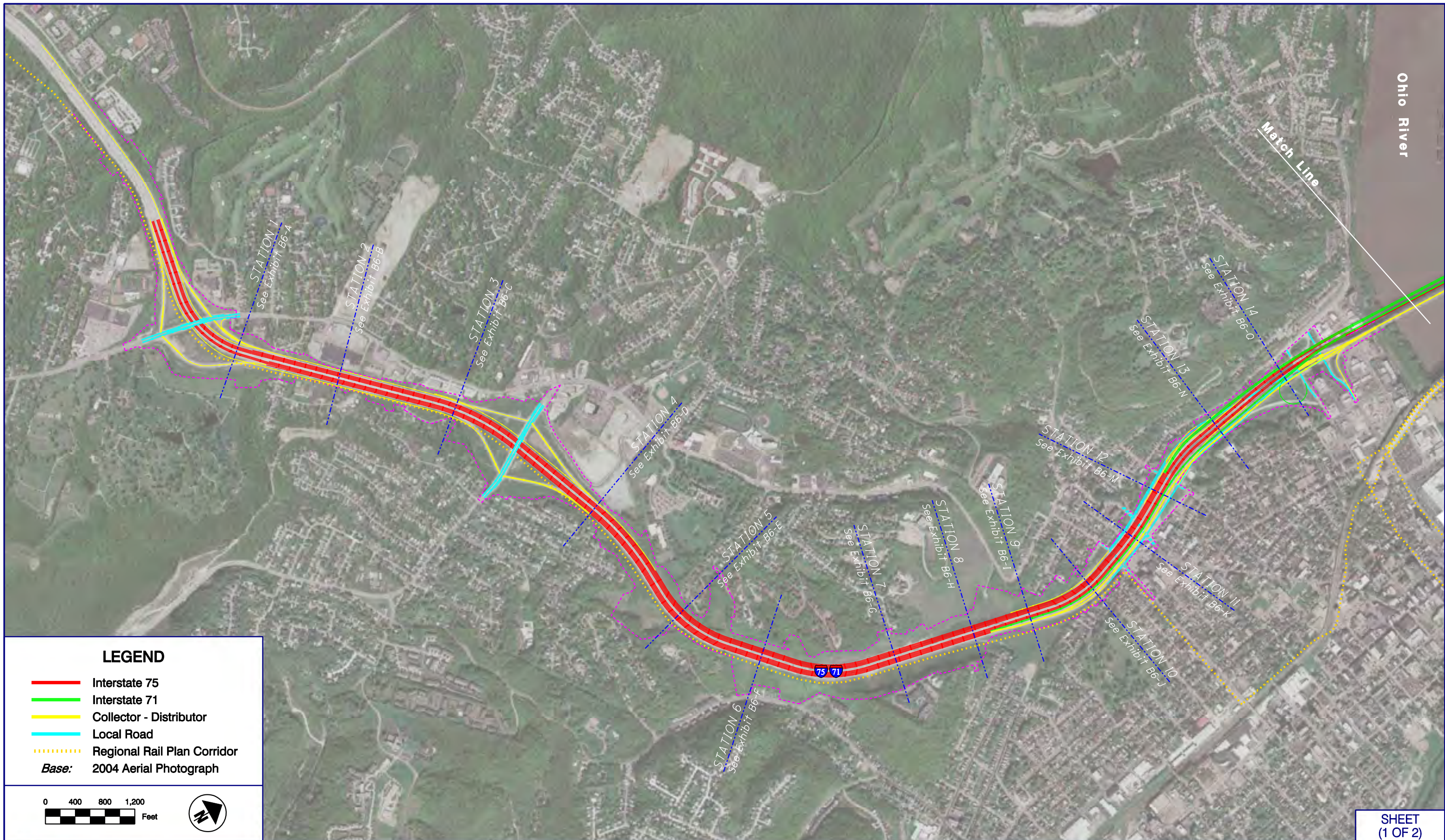

Ohio River

Match Line

**LEGEND**

- Interstate 75
- Interstate 71
- Collector - Distributor
- Local Road
- Regional Rail Plan Corridor
- Base:* 2004 Aerial Photograph

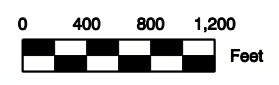

**CRITICAL CROSS SECTIONS PLAN  
ALTERNATIVE E (KENTUCKY)**

SHEET  
(1 OF 2)

**EXHIBIT  
B4-A**

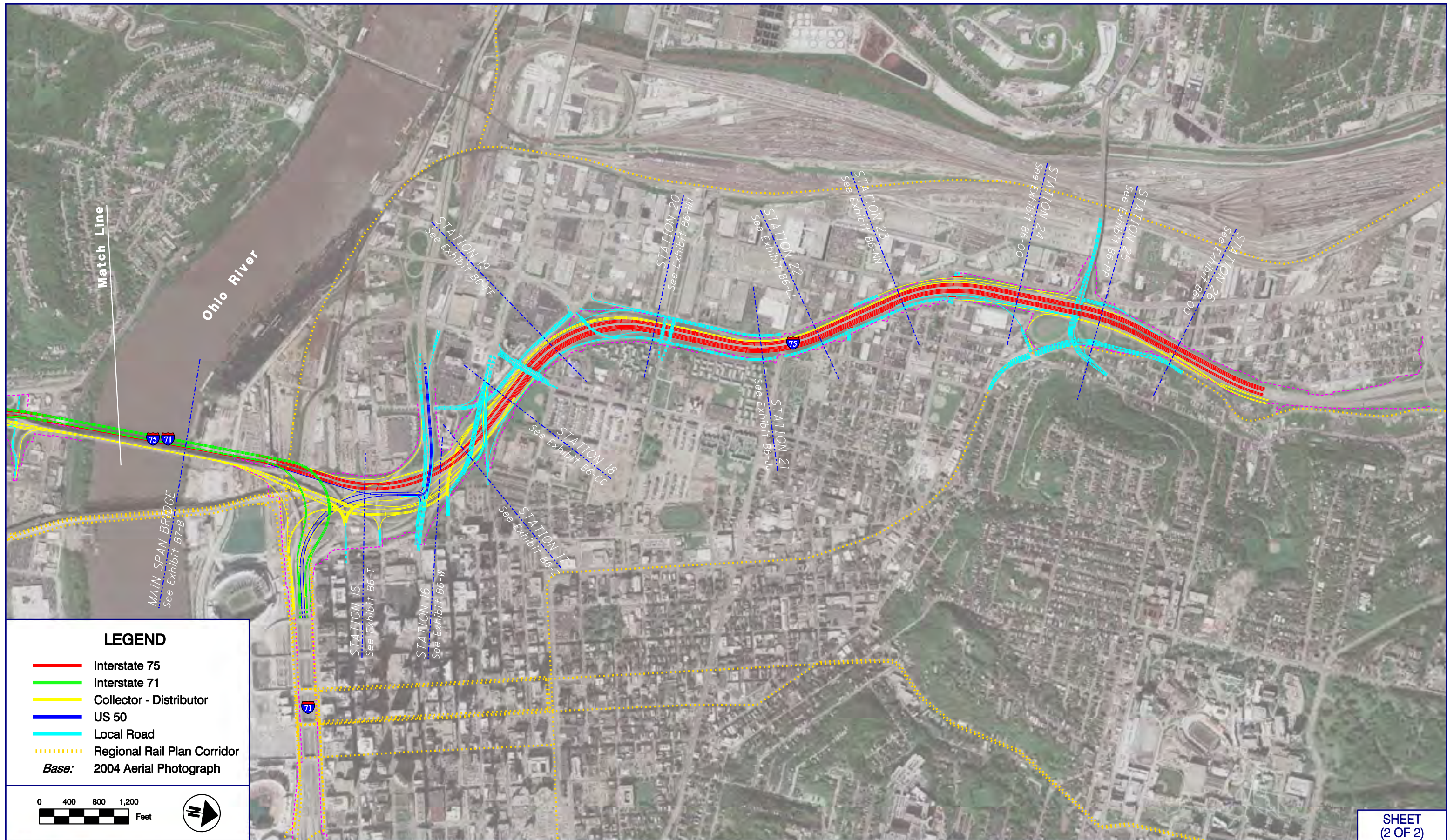

**LEGEND**

- Interstate 75
  - Interstate 71
  - Collector - Distributor
  - US 50
  - Local Road
  - Regional Rail Plan Corridor
- Base:* 2004 Aerial Photograph

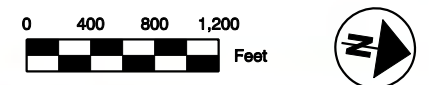

**CRITICAL CROSS  
SECTIONS PLAN  
ALTERNATIVE E (OHIO)**

SHEET  
(2 OF 2)  
**EXHIBIT  
B4-B**

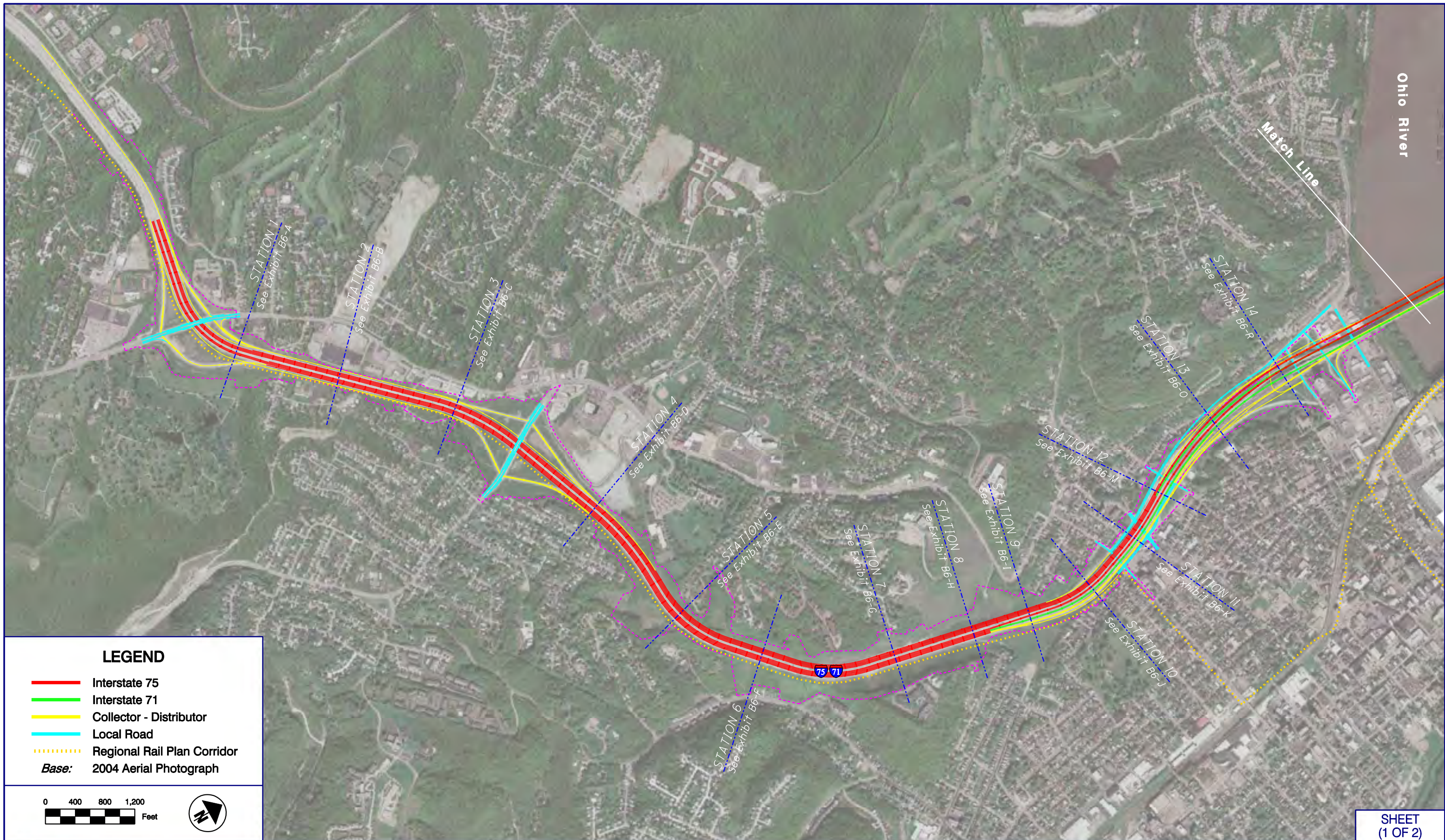

Ohio River

Match Line

STATION 1  
See Exhibit B6-A

STATION 2  
See Exhibit B6-B

STATION 3  
See Exhibit B6-C

STATION 4  
See Exhibit B6-D

STATION 5  
See Exhibit B6-E

STATION 7  
See Exhibit B6-G

STATION 8  
See Exhibit B6-H

STATION 9  
See Exhibit B6-I

STATION 12  
See Exhibit B6-M

STATION 13  
See Exhibit B6-O

STATION 14  
See Exhibit B6-R

STATION 11  
See Exhibit B6-K

STATION 10  
See Exhibit B6-J

**LEGEND**

- Interstate 75
- Interstate 71
- Collector - Distributor
- Local Road
- - - - - Regional Rail Plan Corridor
- Base:* 2004 Aerial Photograph

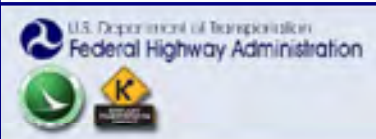
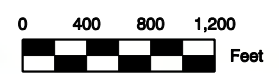

**CRITICAL CROSS SECTIONS PLAN  
ALTERNATIVE G (KENTUCKY)**

SHEET  
(1 OF 2)

**EXHIBIT  
B5-A**



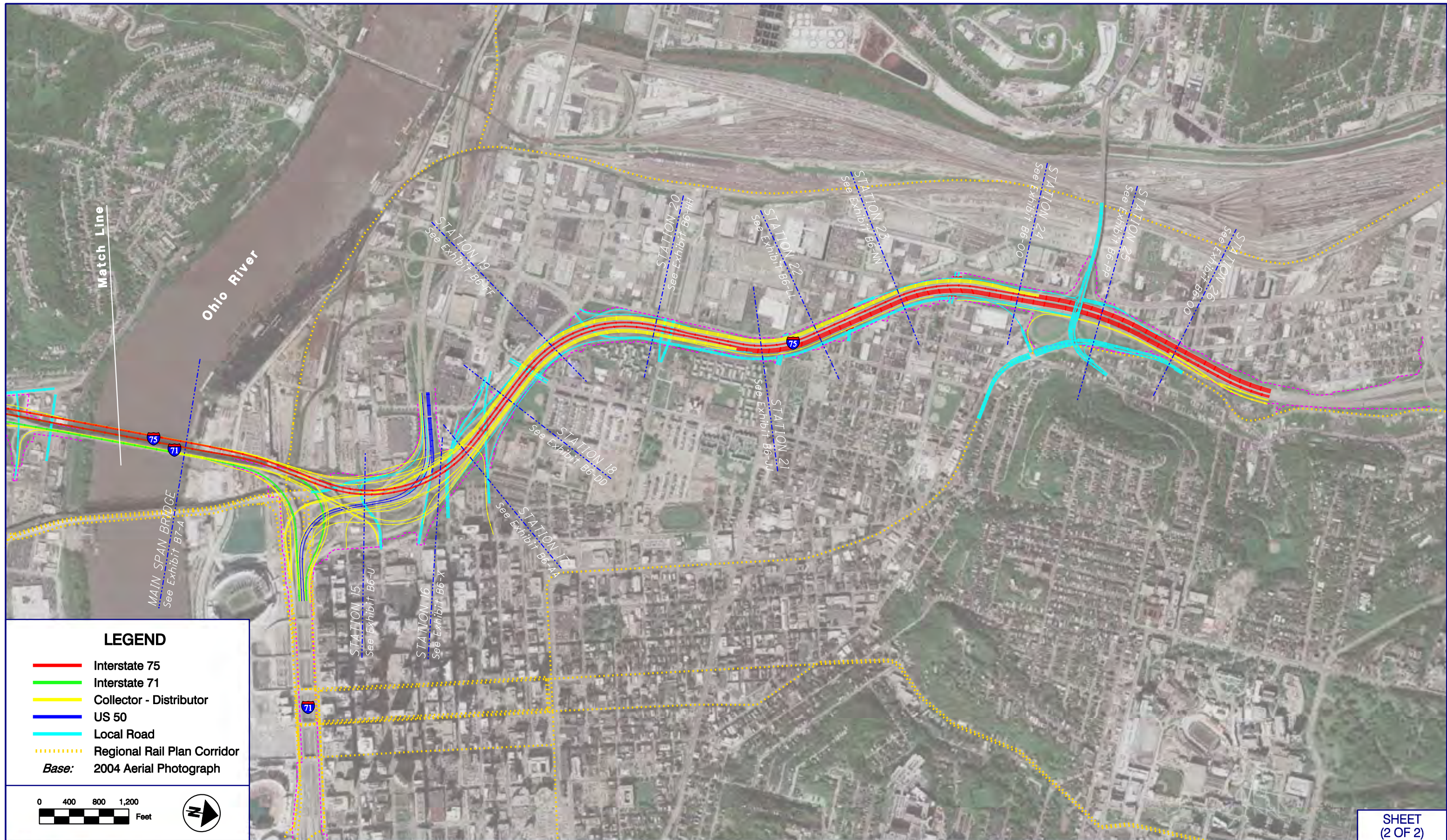

**LEGEND**

- Interstate 75
  - Interstate 71
  - Collector - Distributor
  - US 50
  - Local Road
  - Regional Rail Plan Corridor
- Base:* 2004 Aerial Photograph

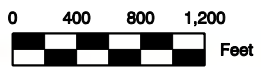

U.S. Department of Transportation  
Federal Highway Administration



Prepared by  
**PARSONS**  
BRINCKERHOFF

**CRITICAL CROSS  
SECTIONS PLAN  
ALTERNATIVE G (OHIO)**

SHEET  
(2 OF 2)

**EXHIBIT  
B5-B**

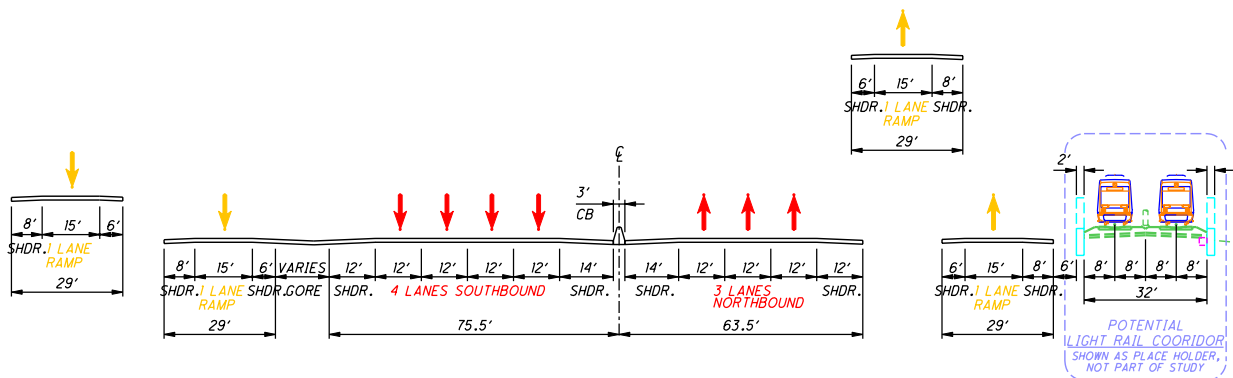

ALTERNATIVES B, C, D, E, & G

NOTE:  
DESIGN CRITERIA FOR SHOULDER AND ROADWAY WIDTHS BASED ON:

OHIO  
ODOT LOCATION AND DESIGN MANUAL, VOL. 1

KENTUCKY  
KYTC HIGHWAY DESIGN MANUAL  
AASHTO ROADSIDE DESIGN GUIDE  
AASHTO "GREEN BOOK" (A POLICY ON GEOMETRIC DESIGN OF HIGHWAYS AND STREETS)

SHEET  
(1 OF 43)

CRITICAL PROPOSED CROSS SECTIONS  
STATION 1

EXHIBIT  
B6-A



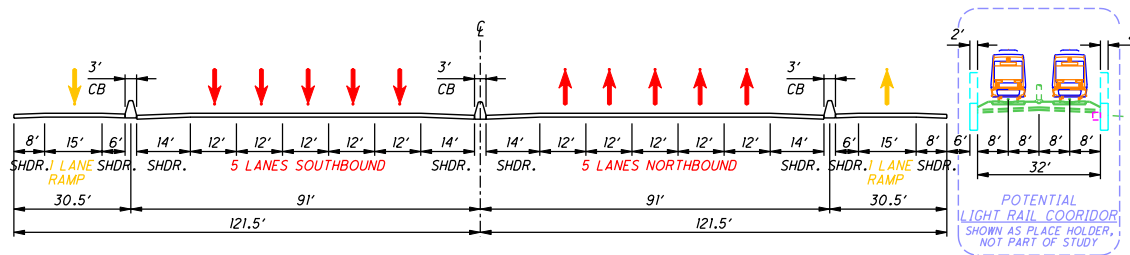

ALTERNATIVES B, C, D, E, & G

**NOTE:**  
DESIGN CRITERIA FOR SHOULDER AND ROADWAY WIDTHS BASED ON:

OHIO  
ODOT LOCATION AND DESIGN MANUAL, VOL. 1

KENTUCKY  
KYTC HIGHWAY DESIGN MANUAL  
AASHTO ROADSIDE DESIGN GUIDE  
AASHTO "GREEN BOOK" (A POLICY ON GEOMETRIC DESIGN OF HIGHWAYS AND STREETS)

SHEET  
(2 OF 43)

EXHIBIT

B6-B

**CRITICAL PROPOSED CROSS SECTIONS  
STATION 2**



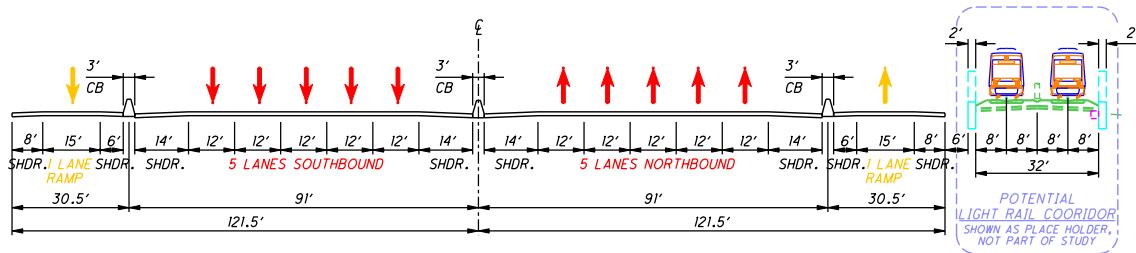

ALTERNATIVES B, C, D, E, & G

NOTE:  
DESIGN CRITERIA FOR SHOULDER AND ROADWAY WIDTHS BASED ON:

OHIO  
ODOT LOCATION AND DESIGN MANUAL, VOL. 1

KENTUCKY  
KYTC HIGHWAY DESIGN MANUAL  
AASHTO ROADSIDE DESIGN GUIDE  
AASHTO "GREEN BOOK" (A POLICY ON GEOMETRIC DESIGN OF HIGHWAYS AND STREETS)

SHEET  
(3 OF 43)

**CRITICAL PROPOSED CROSS SECTIONS  
STATION 3**

**EXHIBIT  
B6-C**



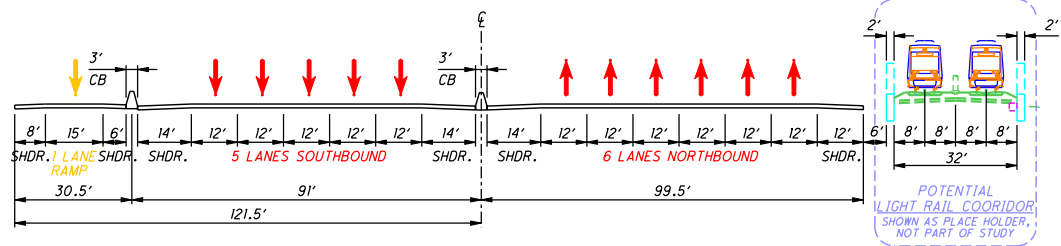

ALTERNATIVES B, C, E, & G

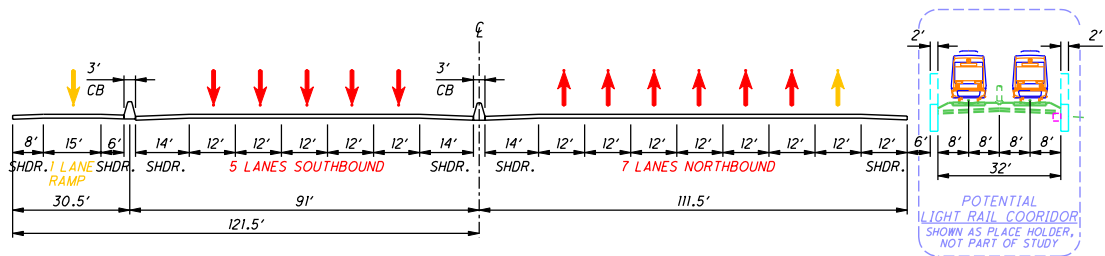

ALTERNATIVE D

NOTE:  
DESIGN CRITERIA FOR SHOULDER AND ROADWAY WIDTHS BASED ON:

OHIO  
ODOT LOCATION AND DESIGN MANUAL, VOL. 1

KENTUCKY  
KYTC HIGHWAY DESIGN MANUAL  
AASHTO ROADSIDE DESIGN GUIDE  
AASHTO "GREEN BOOK" (A POLICY ON GEOMETRIC DESIGN OF HIGHWAYS AND STREETS)

SHEET  
(4 OF 43)

EXHIBIT  
B6-D

CRITICAL PROPOSED CROSS SECTIONS  
STATION 4

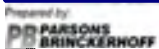

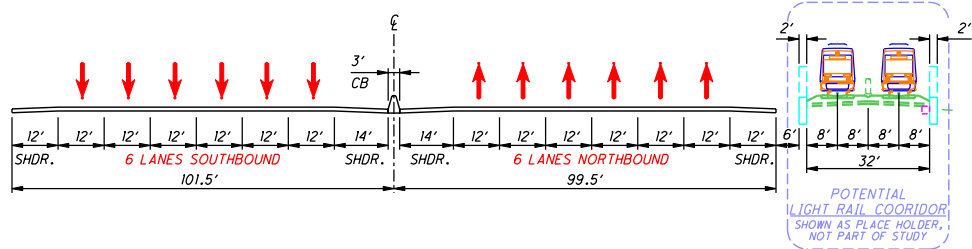

ALTERNATIVES B, C, D, E, & G

NOTE:  
DESIGN CRITERIA FOR SHOULDER AND ROADWAY WIDTHS BASED ON:

OHIO  
ODOT LOCATION AND DESIGN MANUAL, VOL. 1

KENTUCKY  
KYTC HIGHWAY DESIGN MANUAL  
AASHTO ROADSIDE DESIGN GUIDE  
AASHTO "GREEN BOOK" (A POLICY ON GEOMETRIC DESIGN OF HIGHWAYS AND STREETS)

SHEET  
(5 OF 43)

**CRITICAL PROPOSED CROSS SECTIONS  
STATION 5**

**EXHIBIT  
B6-E**

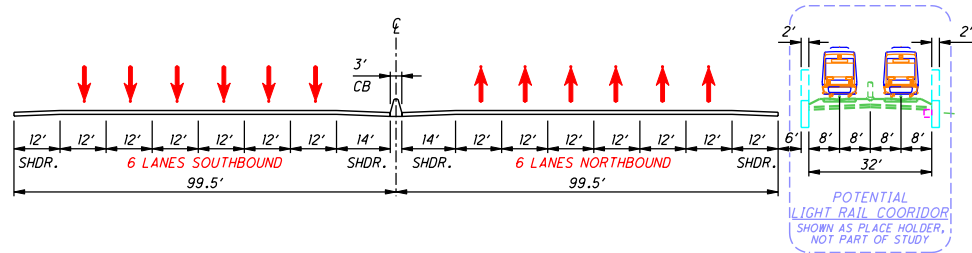

ALTERNATIVES B, C, D, E, & G

**NOTE:**  
DESIGN CRITERIA FOR SHOULDER AND ROADWAY WIDTHS BASED ON:

OHIO  
ODOT LOCATION AND DESIGN MANUAL, VOL. 1

KENTUCKY  
KYTC HIGHWAY DESIGN MANUAL  
AASHTO ROADSIDE DESIGN GUIDE  
AASHTO "GREEN BOOK" (A POLICY ON GEOMETRIC DESIGN OF HIGHWAYS AND STREETS)

SHEET  
(6 OF 43)

**CRITICAL PROPOSED CROSS SECTIONS  
STATION 6**

**EXHIBIT  
B6-F**

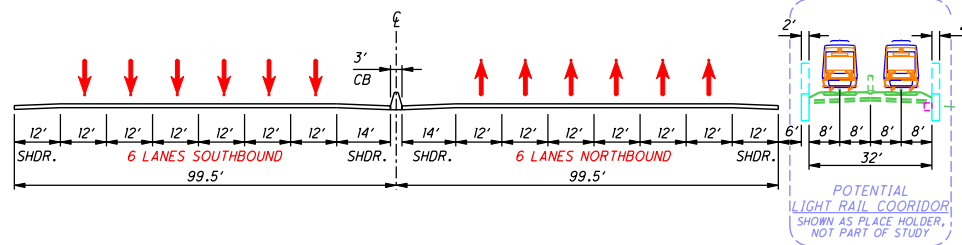

ALTERNATIVES B, C, D, E, & G

NOTE:  
DESIGN CRITERIA FOR SHOULDER AND ROADWAY WIDTHS BASED ON:

OHIO  
ODOT LOCATION AND DESIGN MANUAL, VOL. 1

KENTUCKY  
KYTC HIGHWAY DESIGN MANUAL  
AASHTO ROADSIDE DESIGN GUIDE  
AASHTO "GREEN BOOK" (A POLICY ON GEOMETRIC DESIGN OF HIGHWAYS AND STREETS)

SHEET  
(7 OF 43)

CRITICAL PROPOSED CROSS SECTIONS  
STATION 7

EXHIBIT  
B6-G





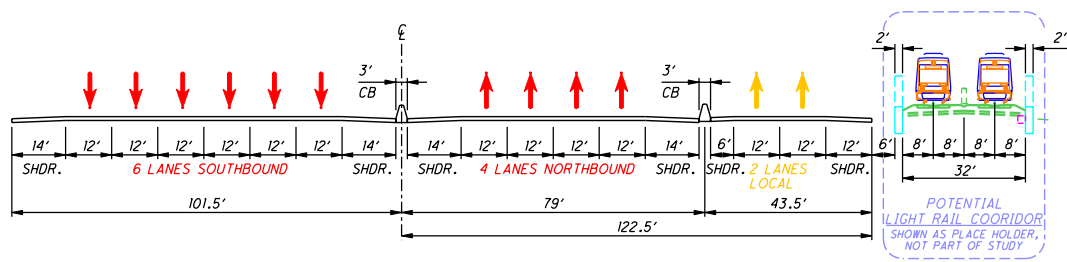

ALTERNATIVES B, C, D, E, & G

NOTE:  
 DESIGN CRITERIA FOR SHOULDER AND ROADWAY WIDTHS BASED ON:  
 OHIO  
 ODOT LOCATION AND DESIGN MANUAL, VOL. 1  
 KENTUCKY  
 KYTC HIGHWAY DESIGN MANUAL  
 AASHTO ROADSIDE DESIGN GUIDE  
 AASHTO "GREEN BOOK" (A POLICY ON GEOMETRIC DESIGN OF HIGHWAYS AND STREETS)

**CRITICAL PROPOSED CROSS SECTIONS  
 STATION 8**



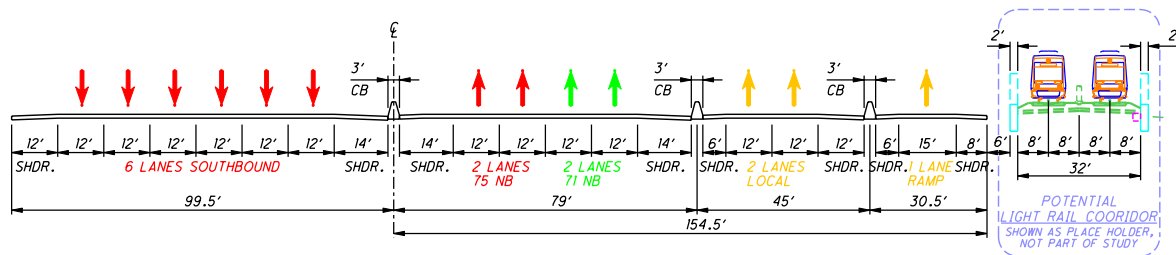

ALTERNATIVE B

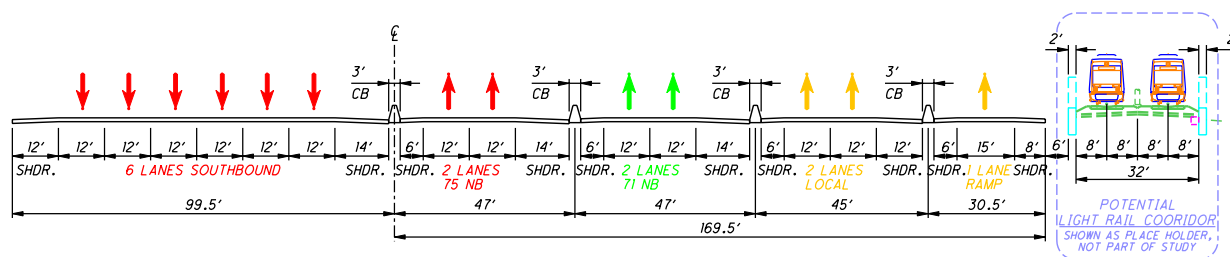

ALTERNATIVES C, D, & G

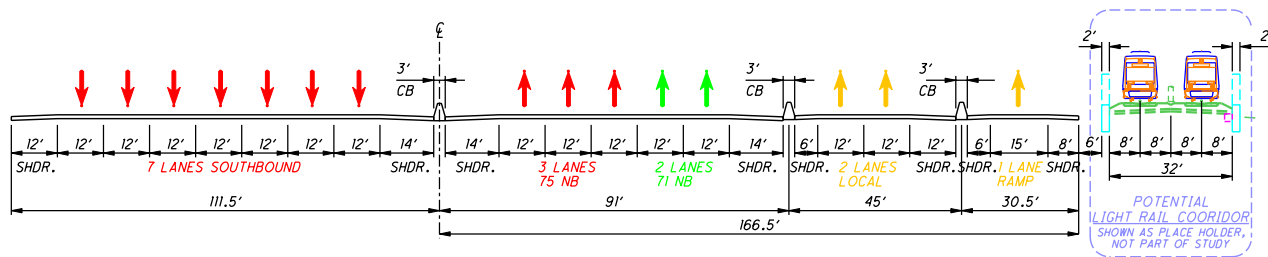

ALTERNATIVE E

NOTE:  
DESIGN CRITERIA FOR SHOULDER AND ROADWAY WIDTHS BASED ON:

OHIO  
ODOT LOCATION AND DESIGN MANUAL, VOL. 1

KENTUCKY  
KYTC HIGHWAY DESIGN MANUAL  
AASHTO ROADSIDE DESIGN GUIDE  
AASHTO "GREEN BOOK" (A POLICY ON GEOMETRIC DESIGN OF HIGHWAYS AND STREETS)

CRITICAL PROPOSED CROSS SECTIONS  
STATION 9

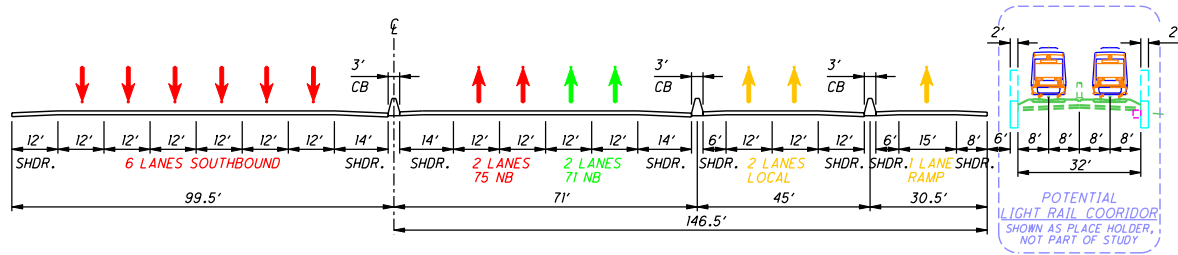

ALTERNATIVE B

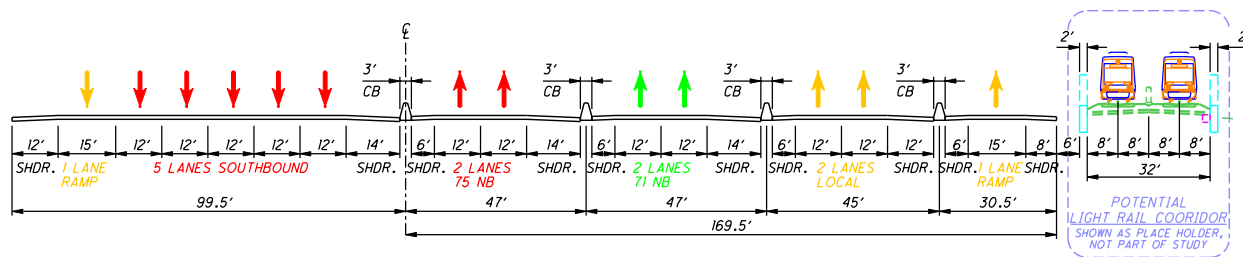

ALTERNATIVES C, D, & G

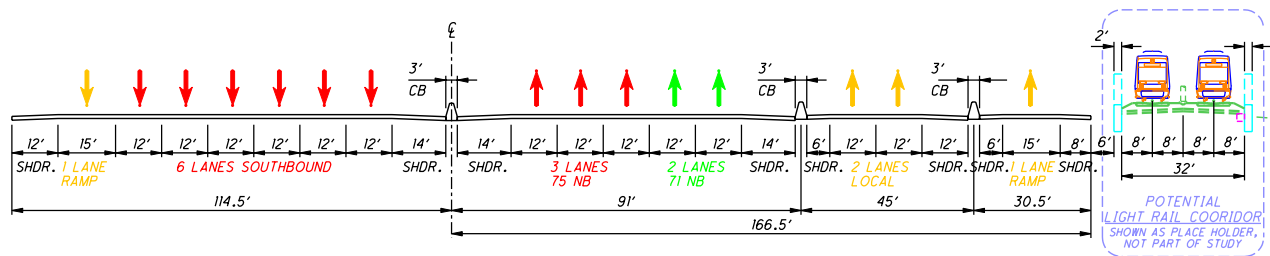

ALTERNATIVE E

NOTE:  
DESIGN CRITERIA FOR SHOULDER AND ROADWAY WIDTHS BASED ON:

OHIO  
ODOT LOCATION AND DESIGN MANUAL, VOL. 1

KENTUCKY  
KYTC HIGHWAY DESIGN MANUAL  
AASHTO ROADSIDE DESIGN GUIDE  
AASHTO "GREEN BOOK" (A POLICY ON GEOMETRIC DESIGN OF HIGHWAYS AND STREETS)

SHEET  
(10 OF 43)

EXHIBIT

B6-J

CRITICAL PROPOSED CROSS SECTIONS  
STATION 10

NOTE:  
DESIGN CRITERIA FOR SHOULDER AND  
ROADWAY WIDTHS BASED ON:

OHIO  
ODOT LOCATION AND DESIGN MANUAL, VOL. 1

KENTUCKY  
KYTC HIGHWAY DESIGN MANUAL  
AASHTO ROADSIDE DESIGN GUIDE  
AASHTO "GREEN BOOK"  
(A POLICY ON GEOMETRIC DESIGN  
OF HIGHWAYS AND STREETS)

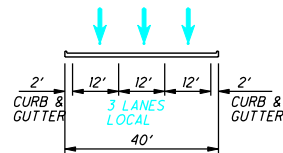
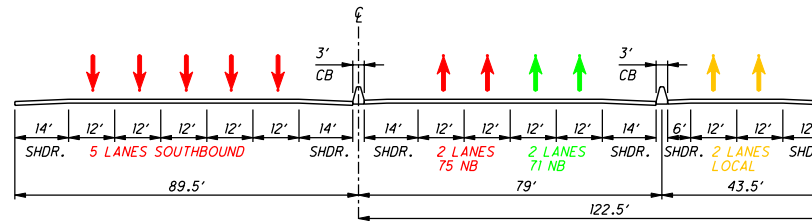

ALTERNATIVE B

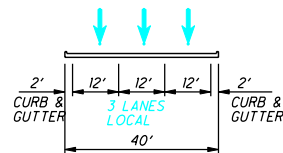
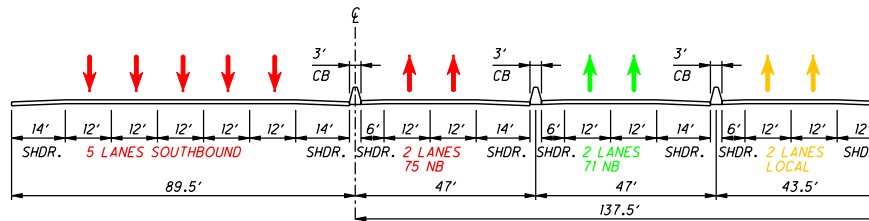
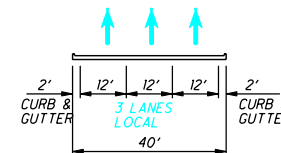

ALTERNATIVES C, D, & G

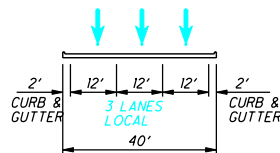
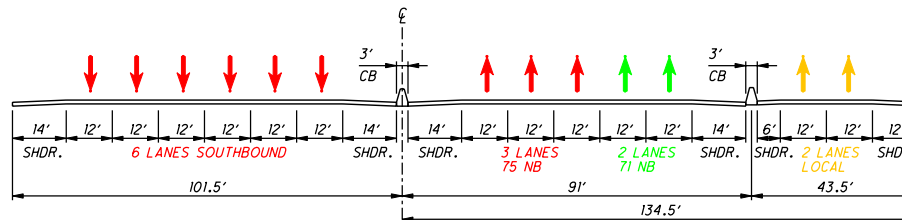
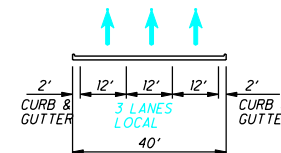

ALTERNATIVE E

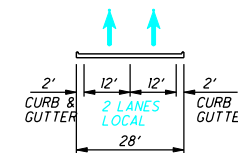

SHEET  
(11 OF 43)

EXHIBIT  
B6-K

CRITICAL PROPOSED CROSS SECTIONS  
STATION 11

NOTE:  
DESIGN CRITERIA FOR SHOULDER AND  
ROADWAY WIDTHS BASED ON:

OHIO  
ODOT LOCATION AND DESIGN MANUAL, VOL. 1

KENTUCKY  
KYTC HIGHWAY DESIGN MANUAL  
AASHTO ROADSIDE DESIGN GUIDE  
AASHTO "GREEN BOOK"  
(A POLICY ON GEOMETRIC DESIGN  
OF HIGHWAYS AND STREETS)

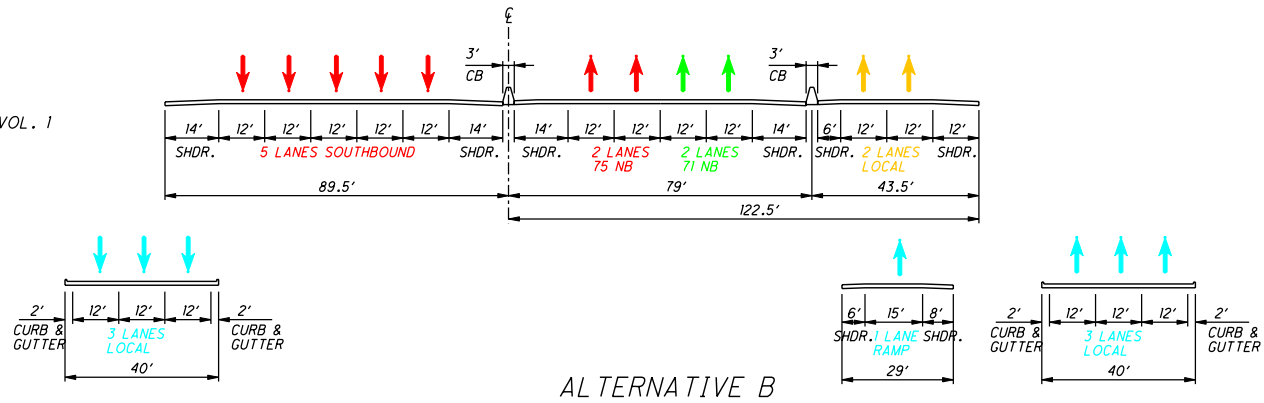

ALTERNATIVE B

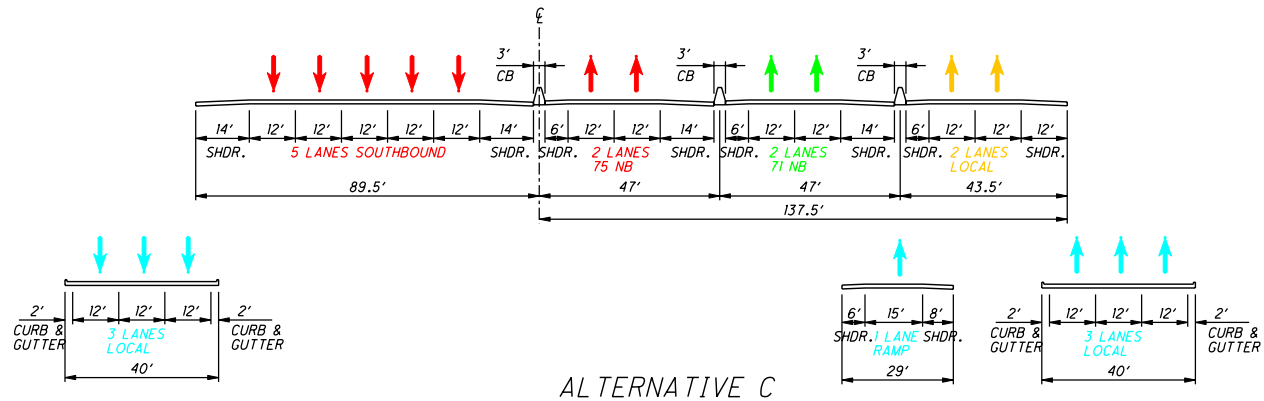

ALTERNATIVE C

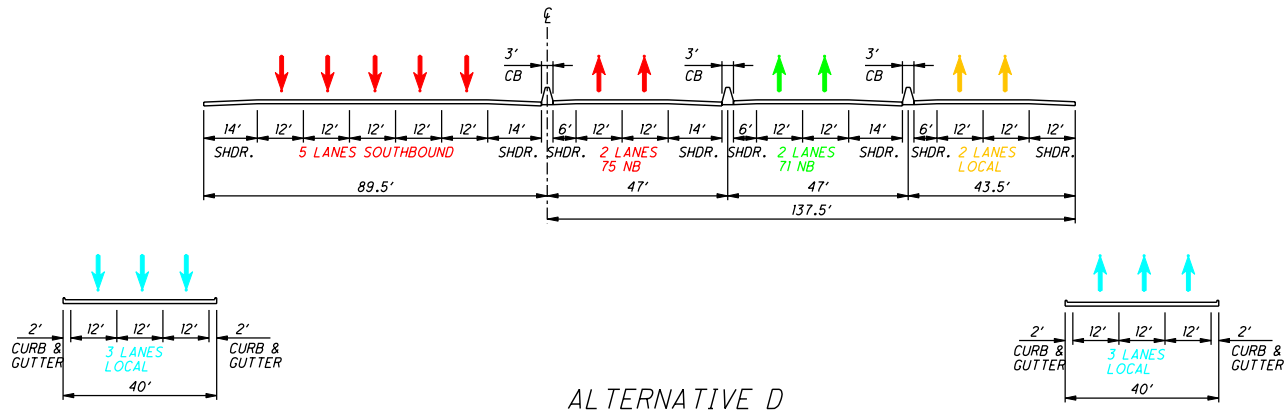

ALTERNATIVE D

SHEET  
(12 OF 43)

EXHIBIT  
B6-L

CRITICAL PROPOSED CROSS SECTIONS  
STATION 12

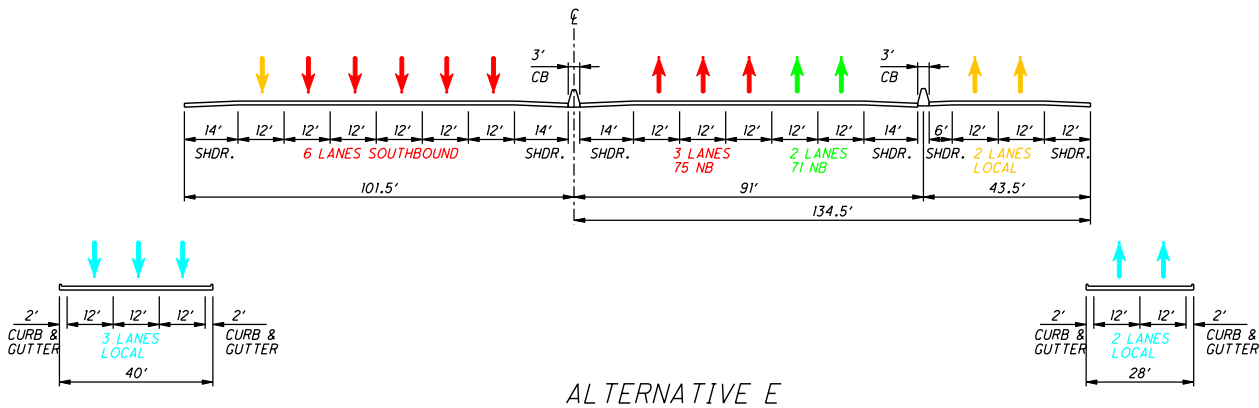

ALTERNATIVE E

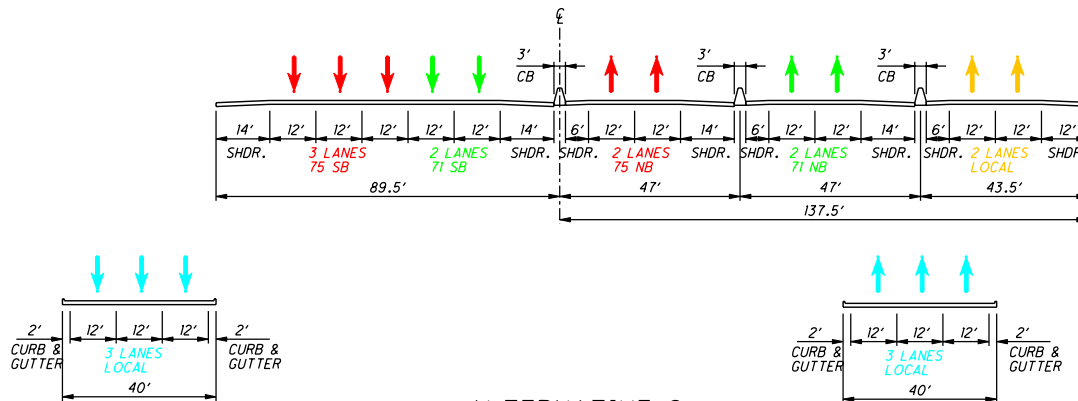

ALTERNATIVE G

NOTE:  
DESIGN CRITERIA FOR SHOULDER AND  
ROADWAY WIDTHS BASED ON:

OHIO  
ODOT LOCATION AND DESIGN MANUAL, VOL. 1

KENTUCKY  
KYTC HIGHWAY DESIGN MANUAL  
AASHTO ROADSIDE DESIGN GUIDE  
AASHTO "GREEN BOOK" (A POLICY ON GEOMETRIC DESIGN OF HIGHWAYS AND STREETS)

SHEET  
(13 OF 43)

EXHIBIT  
B6-M

CRITICAL PROPOSED CROSS SECTIONS  
STATION 12



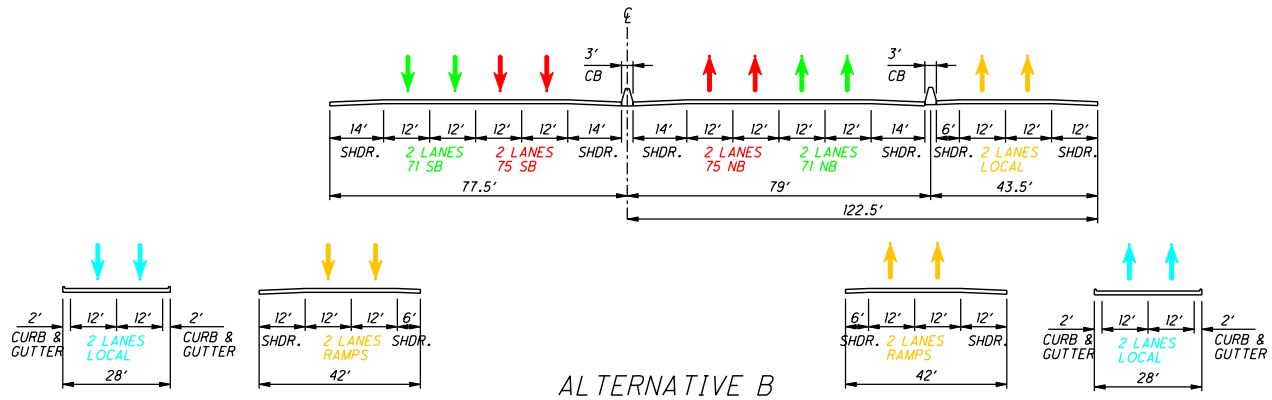

ALTERNATIVE B

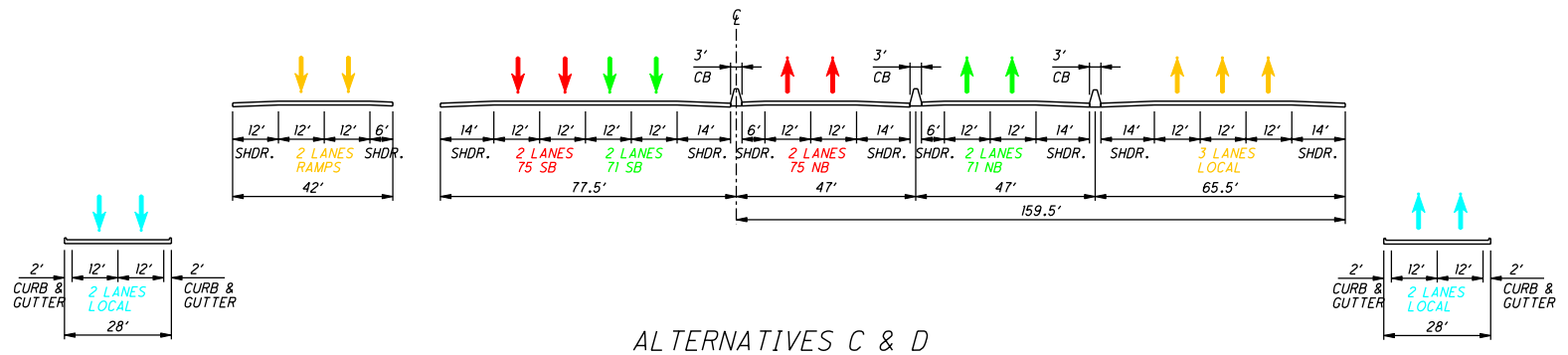

ALTERNATIVES C & D

NOTE:  
DESIGN CRITERIA FOR SHOULDER AND ROADWAY WIDTHS BASED ON:

OHIO  
ODOT LOCATION AND DESIGN MANUAL, VOL. 1

KENTUCKY  
KYTC HIGHWAY DESIGN MANUAL  
AASHTO ROADSIDE DESIGN GUIDE  
AASHTO "GREEN BOOK" (A POLICY ON GEOMETRIC DESIGN OF HIGHWAYS AND STREETS)

SHEET  
(14 OF 43)

EXHIBIT  
B6-N

CRITICAL PROPOSED CROSS SECTIONS  
STATION 13

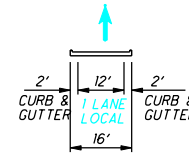
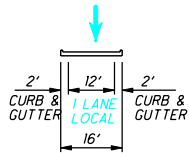
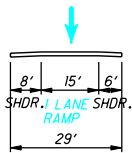
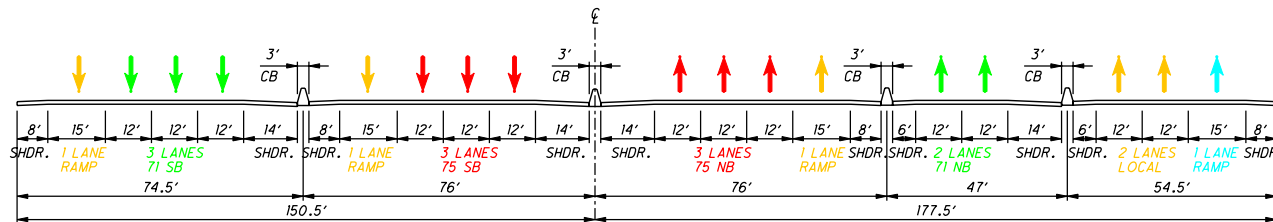

ALTERNATIVE E

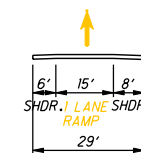
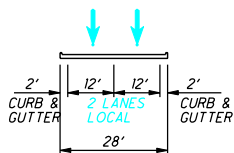
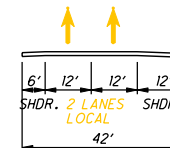
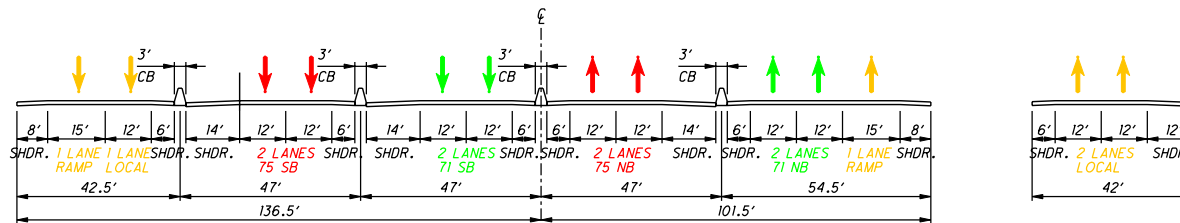

ALTERNATIVE G

NOTE:  
DESIGN CRITERIA FOR SHOULDER AND ROADWAY WIDTHS BASED ON:

OHIO  
ODOT LOCATION AND DESIGN MANUAL, VOL. 1

KENTUCKY  
KYTC HIGHWAY DESIGN MANUAL  
AASHTO ROADSIDE DESIGN GUIDE  
AASHTO "GREEN BOOK" (A POLICY ON GEOMETRIC DESIGN OF HIGHWAYS AND STREETS)

CRITICAL PROPOSED CROSS SECTIONS  
STATION 13



NOTE:  
DESIGN CRITERIA FOR SHOULDER AND  
ROADWAY WIDTHS BASED ON:

OHIO  
ODOT LOCATION AND DESIGN MANUAL, VOL. 1

KENTUCKY  
KYTC HIGHWAY DESIGN MANUAL  
AASHTO ROADSIDE DESIGN GUIDE  
AASHTO "GREEN BOOK"  
(A POLICY ON GEOMETRIC DESIGN  
OF HIGHWAYS AND STREETS)

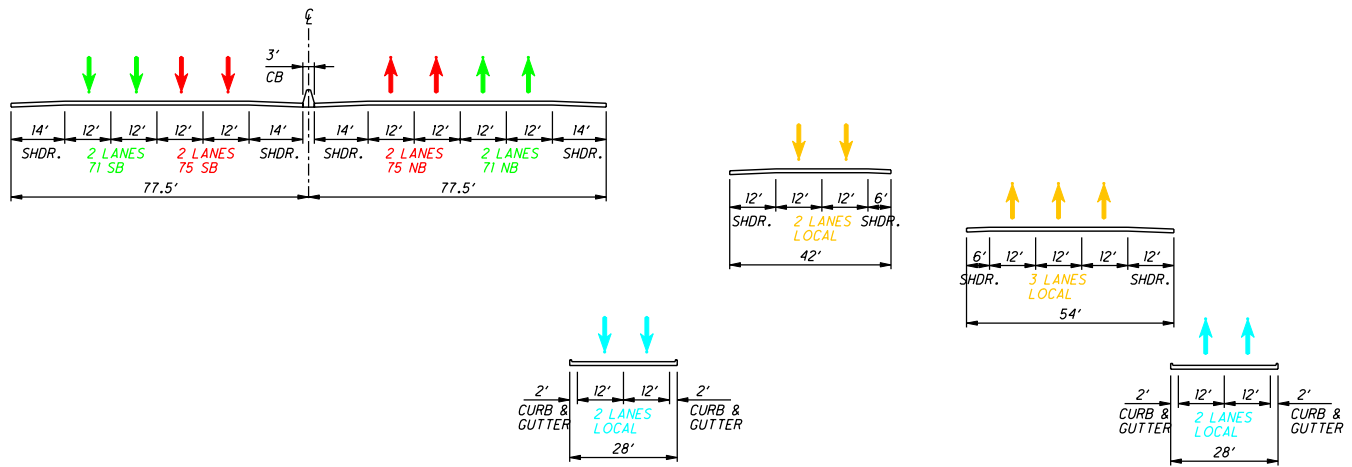

ALTERNATIVE B

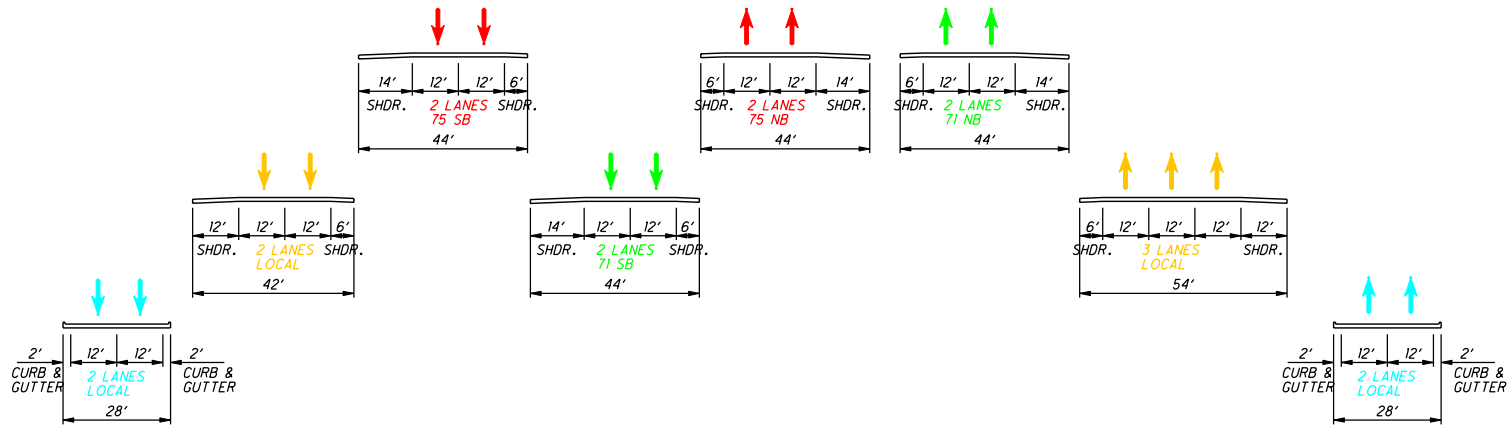

ALTERNATIVES C & D

SHEET  
(16 OF 43)

**CRITICAL PROPOSED CROSS SECTIONS  
STATION 14**

**EXHIBIT  
B6-P**

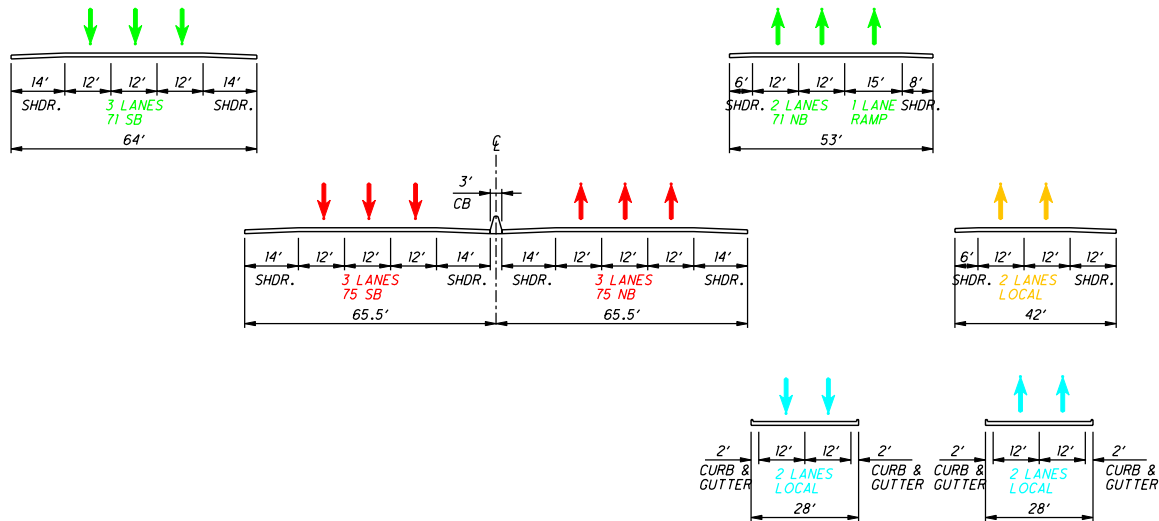

ALTERNATIVE E

NOTE:  
DESIGN CRITERIA FOR SHOULDER AND ROADWAY WIDTHS BASED ON:

OHIO  
ODOT LOCATION AND DESIGN MANUAL, VOL. 1

KENTUCKY  
KYTC HIGHWAY DESIGN MANUAL  
AASHTO ROADSIDE DESIGN GUIDE  
AASHTO "GREEN BOOK" (A POLICY ON GEOMETRIC DESIGN OF HIGHWAYS AND STREETS)

SHEET  
(17 OF 43)

EXHIBIT

B6-Q

CRITICAL PROPOSED CROSS SECTIONS  
STATION 14

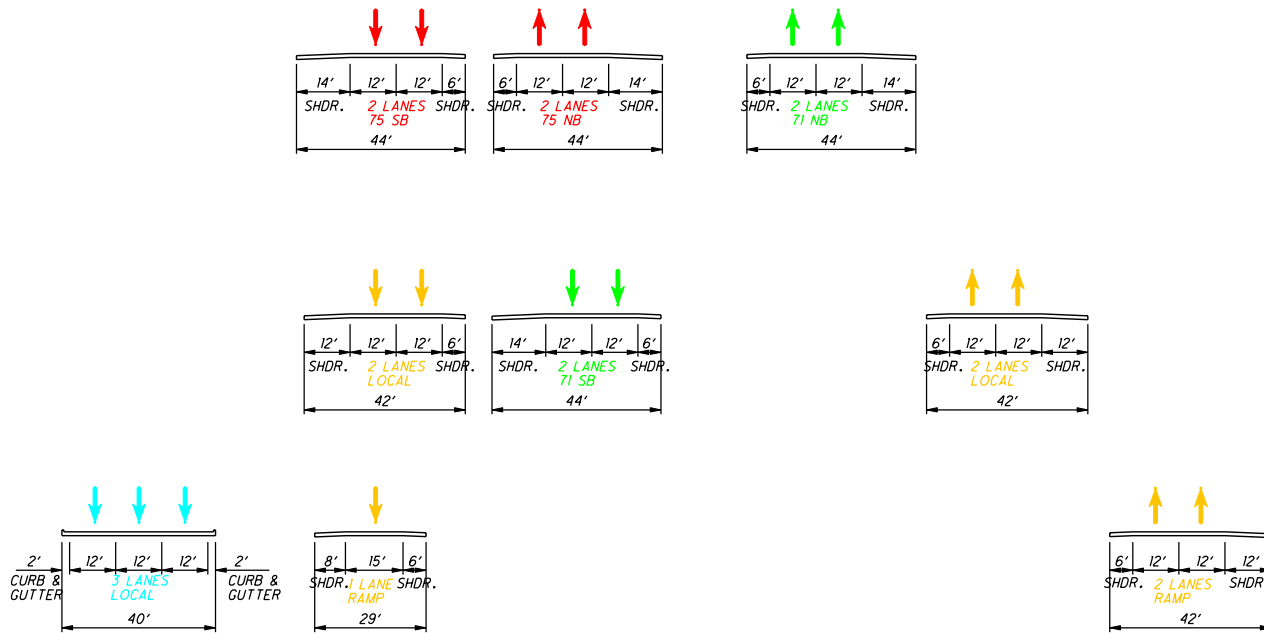

ALTERNATIVE G

NOTE:  
DESIGN CRITERIA FOR SHOULDER AND ROADWAY WIDTHS BASED ON:

OHIO  
ODOT LOCATION AND DESIGN MANUAL, VOL. 1

KENTUCKY  
KYTC HIGHWAY DESIGN MANUAL  
AASHTO ROADSIDE DESIGN GUIDE  
AASHTO "GREEN BOOK" (A POLICY ON GEOMETRIC DESIGN OF HIGHWAYS AND STREETS)

SHEET  
(18 OF 43)

EXHIBIT

B6-R

CRITICAL PROPOSED CROSS SECTIONS  
STATION 14

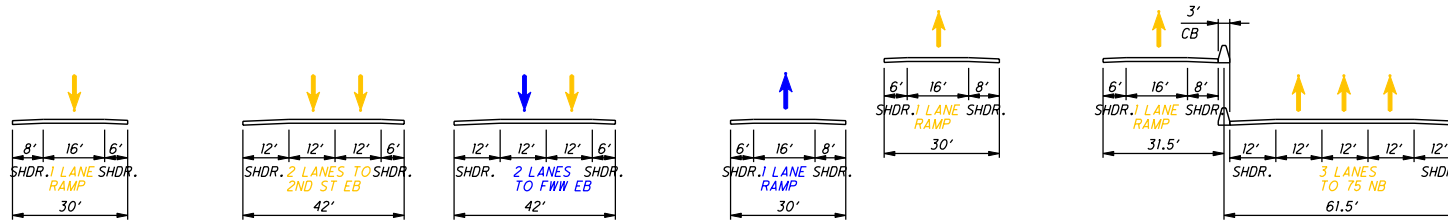

ALTERNATIVE B

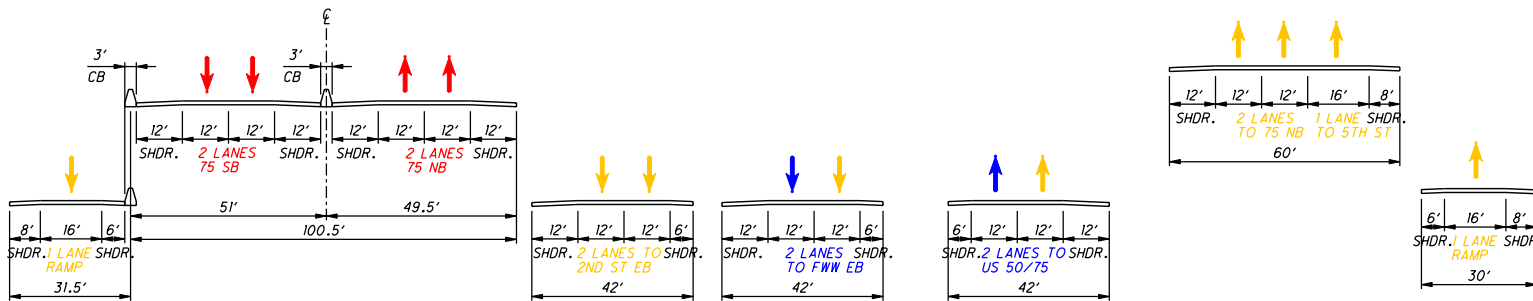

ALTERNATIVE C

NOTE:  
DESIGN CRITERIA FOR SHOULDER AND  
ROADWAY WIDTHS BASED ON:

OHIO  
ODOT LOCATION AND DESIGN MANUAL, VOL. 1

KENTUCKY  
KYTC HIGHWAY DESIGN MANUAL  
AASHTO ROADSIDE DESIGN GUIDE  
AASHTO "GREEN BOOK" (A POLICY ON GEOMETRIC DESIGN OF HIGHWAYS AND STREETS)

SHEET  
(19 OF 43)

EXHIBIT

B6-S

CRITICAL PROPOSED CROSS SECTIONS  
STATION 15

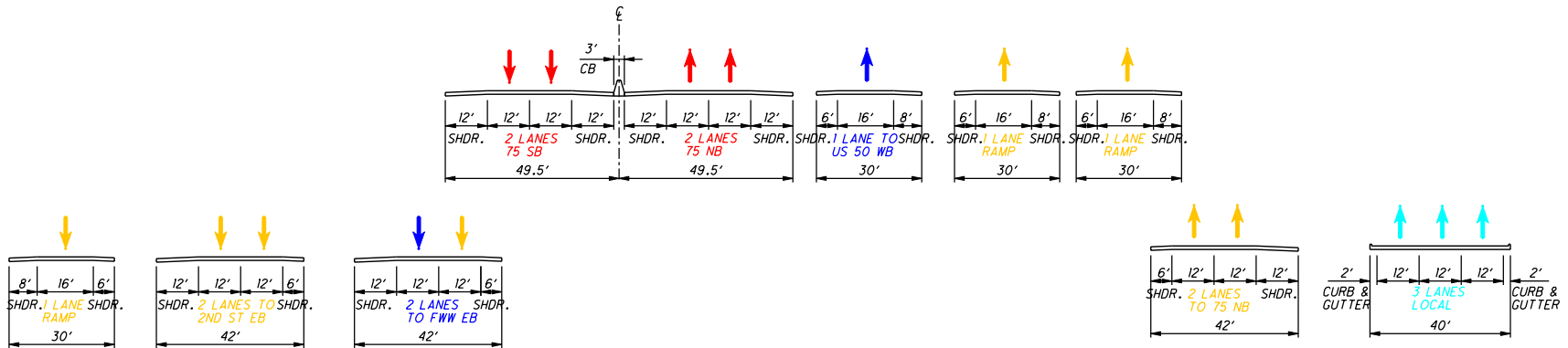

ALTERNATIVE D

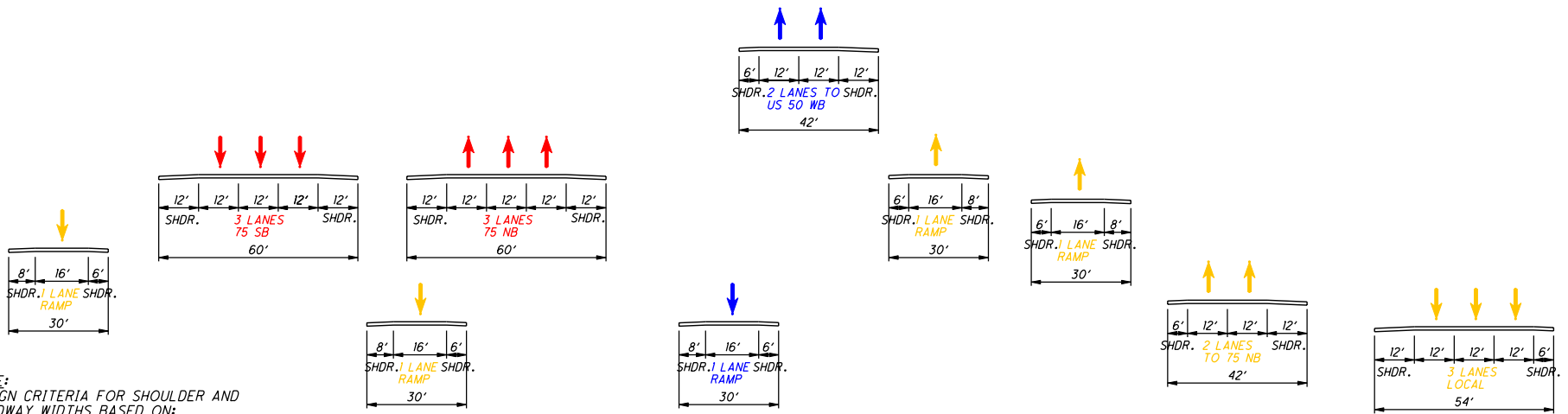

ALTERNATIVE E

NOTE:  
DESIGN CRITERIA FOR SHOULDER AND  
ROADWAY WIDTHS BASED ON:

OHIO  
ODOT LOCATION AND DESIGN MANUAL, VOL. 1

KENTUCKY  
KYTC HIGHWAY DESIGN MANUAL  
AASHTO ROADSIDE DESIGN GUIDE  
AASHTO "GREEN BOOK"  
(A POLICY ON GEOMETRIC DESIGN OF HIGHWAYS AND STREETS)

SHEET  
(20 OF 43)

EXHIBIT

B6-T

CRITICAL PROPOSED CROSS SECTIONS  
STATION 15

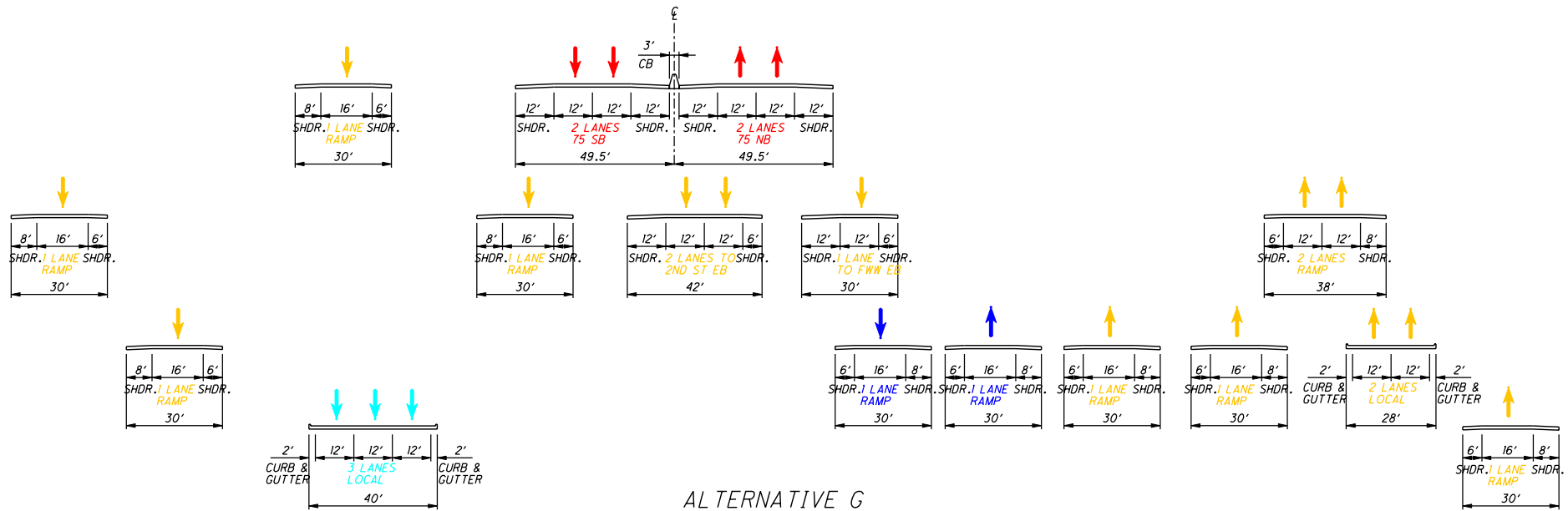

ALTERNATIVE G

NOTE:  
DESIGN CRITERIA FOR SHOULDER AND ROADWAY WIDTHS BASED ON:

OHIO  
ODOT LOCATION AND DESIGN MANUAL, VOL. 1

KENTUCKY  
KYTC HIGHWAY DESIGN MANUAL  
AASHTO ROADSIDE DESIGN GUIDE  
AASHTO "GREEN BOOK" (A POLICY ON GEOMETRIC DESIGN OF HIGHWAYS AND STREETS)

SHEET  
(21 OF 43)

EXHIBIT  
B6-U

CRITICAL PROPOSED CROSS SECTIONS  
STATION 15



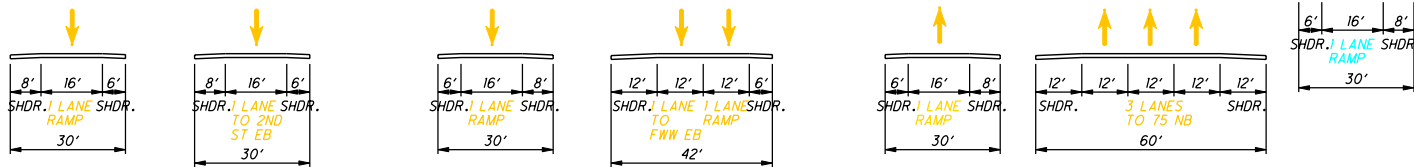

ALTERNATIVE B

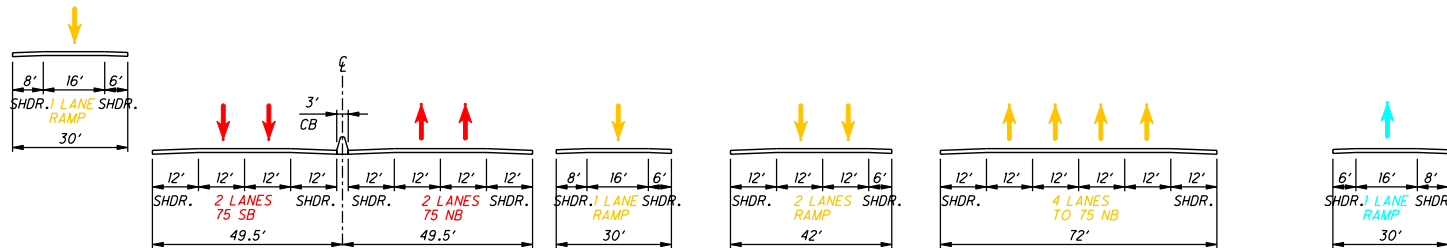

ALTERNATIVE C

NOTE:  
DESIGN CRITERIA FOR SHOULDER AND ROADWAY WIDTHS BASED ON:

OHIO  
ODOT LOCATION AND DESIGN MANUAL, VOL. 1

KENTUCKY  
KYTC HIGHWAY DESIGN MANUAL  
AASHTO ROADSIDE DESIGN GUIDE  
AASHTO "GREEN BOOK" (A POLICY ON GEOMETRIC DESIGN OF HIGHWAYS AND STREETS)

SHEET  
(22 OF 43)

EXHIBIT  
B6-V

CRITICAL PROPOSED CROSS SECTIONS  
STATION 16



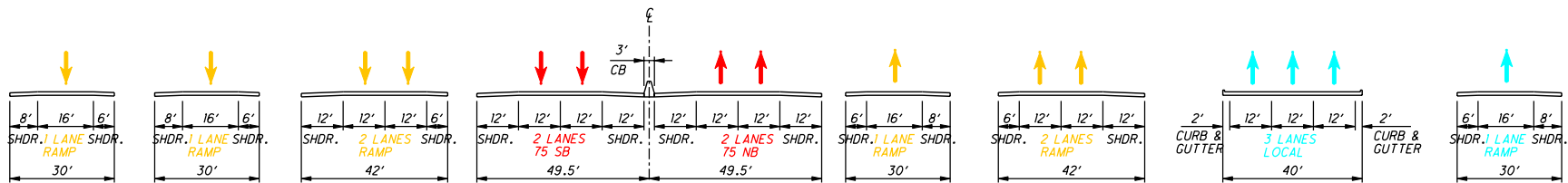

ALTERNATIVE D

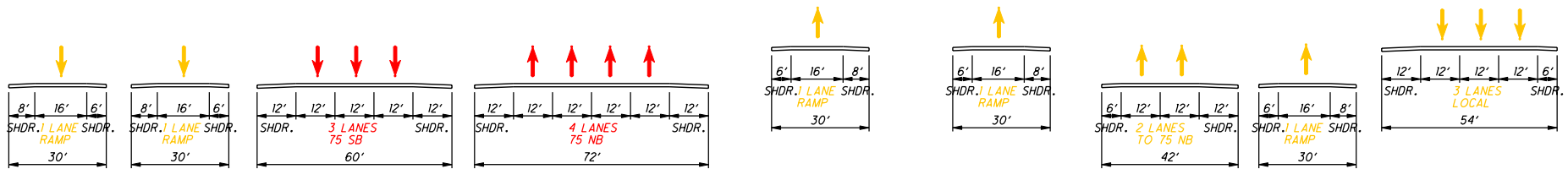

ALTERNATIVE E

NOTE:  
DESIGN CRITERIA FOR SHOULDER AND ROADWAY WIDTHS BASED ON:

OHIO  
ODOT LOCATION AND DESIGN MANUAL, VOL. 1

KENTUCKY  
KYTC HIGHWAY DESIGN MANUAL  
AASHTO ROADSIDE DESIGN GUIDE  
AASHTO "GREEN BOOK" (A POLICY ON GEOMETRIC DESIGN OF HIGHWAYS AND STREETS)



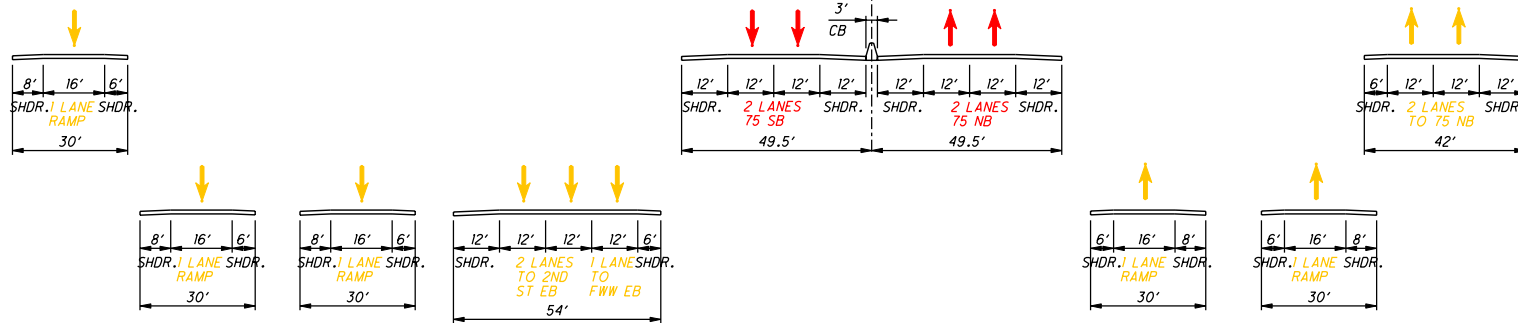

ALTERNATIVE G

NOTE:  
DESIGN CRITERIA FOR SHOULDER AND ROADWAY WIDTHS BASED ON:

OHIO  
ODOT LOCATION AND DESIGN MANUAL, VOL. 1

KENTUCKY  
KYTC HIGHWAY DESIGN MANUAL  
AASHTO ROADSIDE DESIGN GUIDE  
AASHTO "GREEN BOOK" (A POLICY ON GEOMETRIC DESIGN OF HIGHWAYS AND STREETS)

SHEET  
(24 OF 43)

EXHIBIT

B6-X

CRITICAL PROPOSED CROSS SECTIONS  
STATION 16

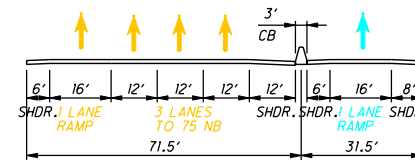
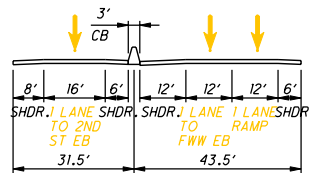
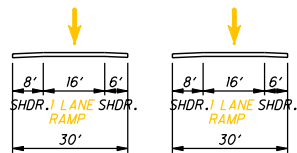
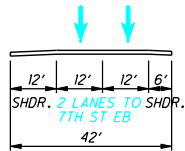

ALTERNATIVE B

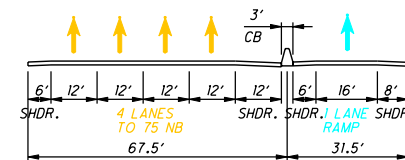
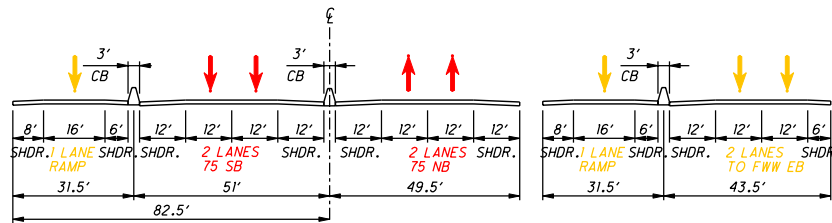
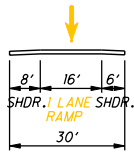
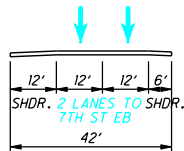

ALTERNATIVE C

NOTE:  
DESIGN CRITERIA FOR SHOULDER AND  
ROADWAY WIDTHS BASED ON:

OHIO  
ODOT LOCATION AND DESIGN MANUAL, VOL. 1

KENTUCKY  
KYTC HIGHWAY DESIGN MANUAL  
AASHTO ROADSIDE DESIGN GUIDE  
AASHTO "GREEN BOOK" (A POLICY ON GEOMETRIC DESIGN OF HIGHWAYS AND STREETS)

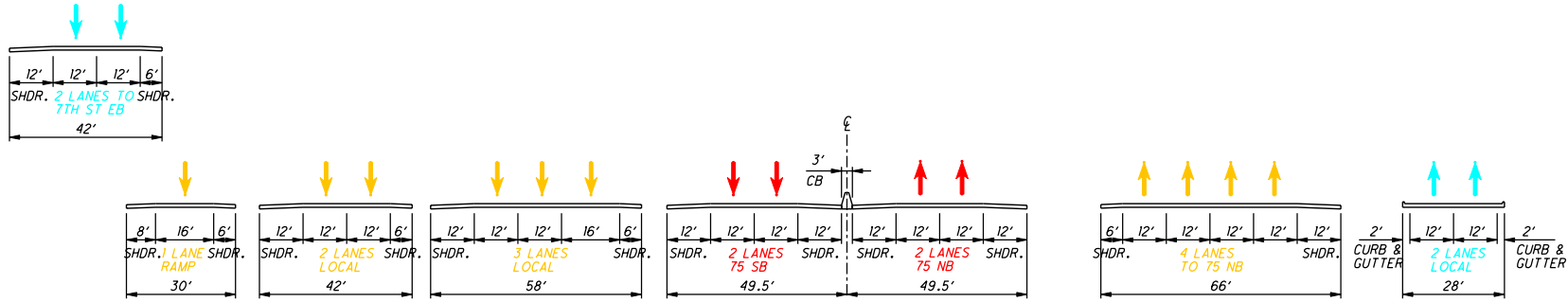

ALTERNATIVE D

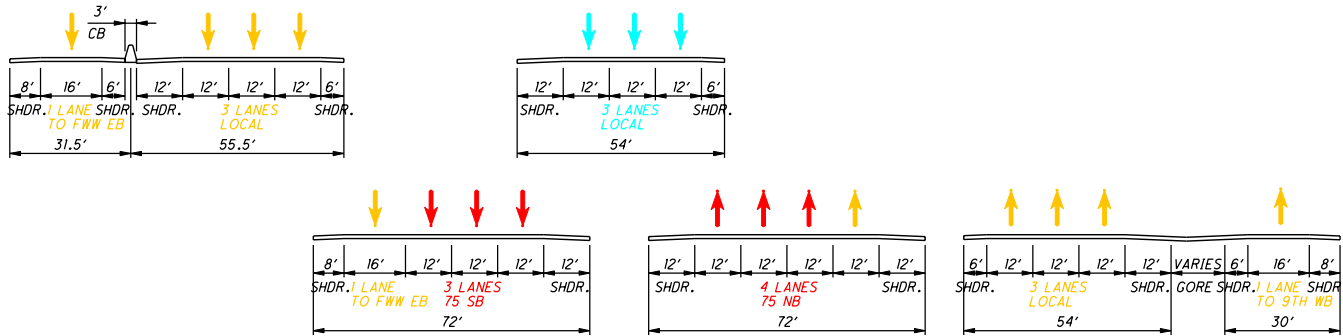

ALTERNATIVE E

NOTE:  
DESIGN CRITERIA FOR SHOULDER AND  
ROADWAY WIDTHS BASED ON:

OHIO  
ODOT LOCATION AND DESIGN MANUAL, VOL. 1

KENTUCKY  
KYTC HIGHWAY DESIGN MANUAL  
AASHTO ROADSIDE DESIGN GUIDE  
AASHTO "GREEN BOOK" (A POLICY ON GEOMETRIC DESIGN OF HIGHWAYS AND STREETS)

SHEET  
(26 OF 43)

EXHIBIT  
B6-Z

CRITICAL PROPOSED CROSS SECTIONS  
STATION 17



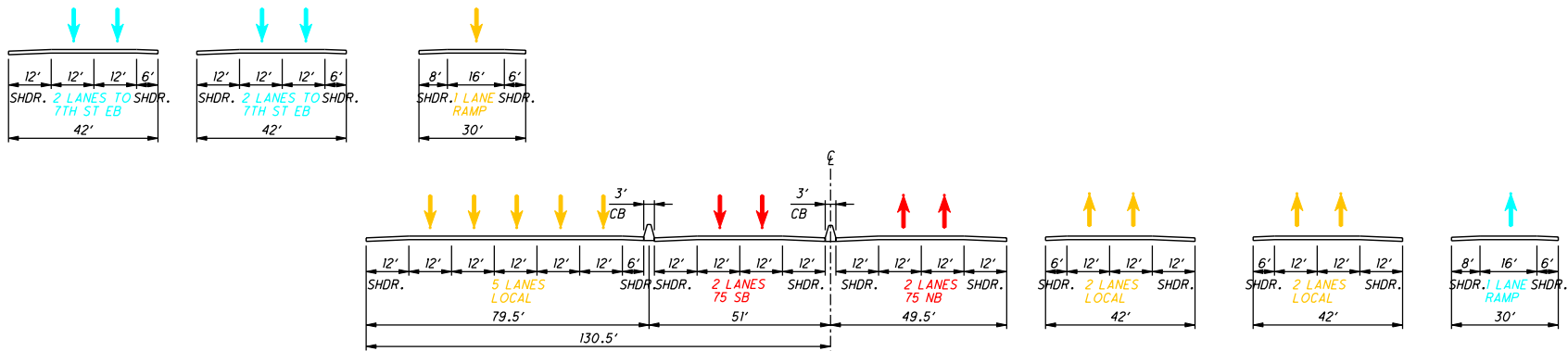

ALTERNATIVE G

NOTE:  
DESIGN CRITERIA FOR SHOULDER AND  
ROADWAY WIDTHS BASED ON:

OHIO  
ODOT LOCATION AND DESIGN MANUAL, VOL. 1

KENTUCKY  
KYTC HIGHWAY DESIGN MANUAL  
AASHTO ROADSIDE DESIGN GUIDE  
AASHTO "GREEN BOOK" (A POLICY ON GEOMETRIC DESIGN OF HIGHWAYS AND STREETS)

SHEET  
(27 OF 43)

EXHIBIT  
B6-AA

U.S. Department of Transportation  
Federal Highway Administration



CRITICAL PROPOSED CROSS SECTIONS  
STATION 17

Prepared by  
PARSONS  
BRINCKERHOFF

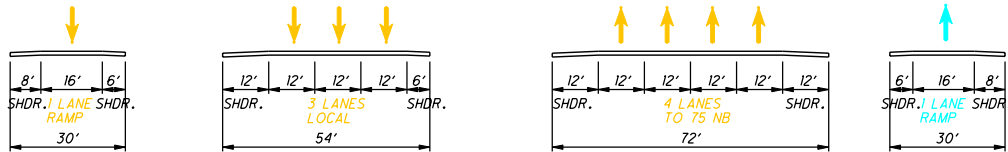

ALTERNATIVE B

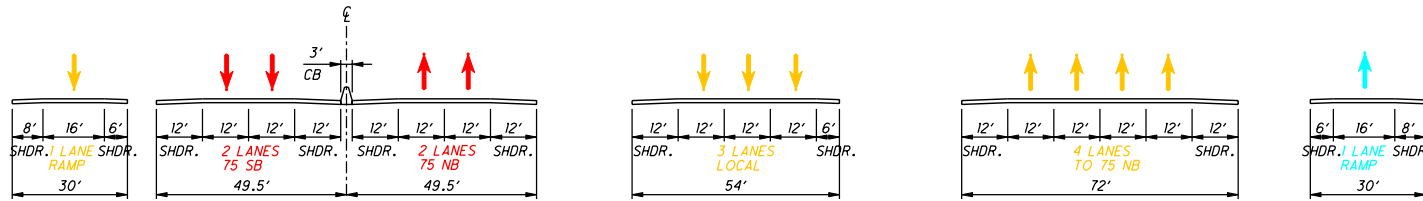

ALTERNATIVE C

NOTE:  
DESIGN CRITERIA FOR SHOULDER AND ROADWAY WIDTHS BASED ON:

OHIO  
ODOT LOCATION AND DESIGN MANUAL, VOL. 1

KENTUCKY  
KYTC HIGHWAY DESIGN MANUAL  
AASHTO ROADSIDE DESIGN GUIDE  
AASHTO "GREEN BOOK"  
(A POLICY ON GEOMETRIC DESIGN OF HIGHWAYS AND STREETS)

SHEET  
(28 OF 43)

EXHIBIT  
B6-BB

CRITICAL PROPOSED CROSS SECTIONS  
STATION 18

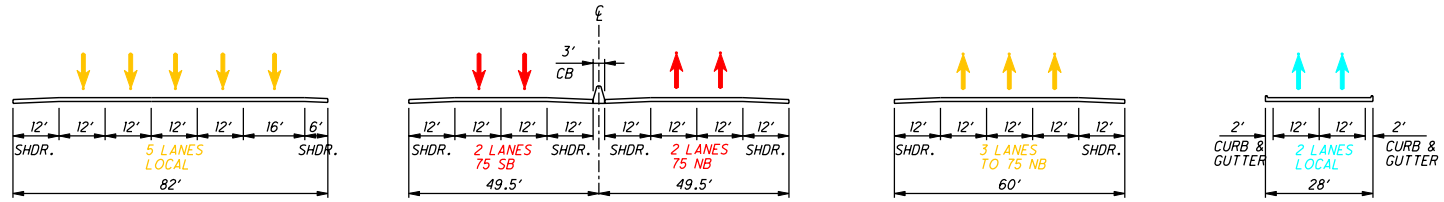

ALTERNATIVE D

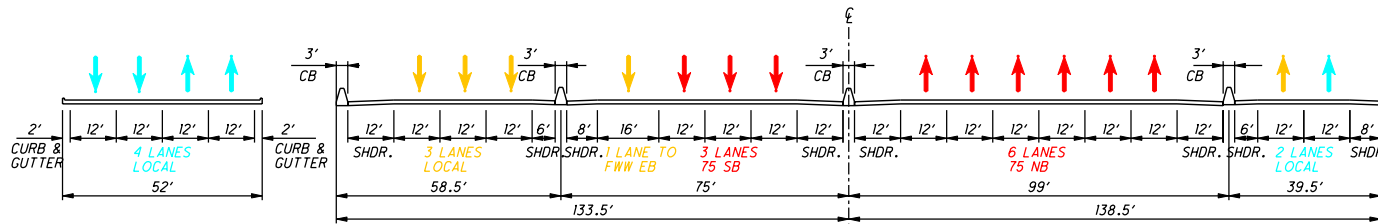

ALTERNATIVE E

NOTE:  
DESIGN CRITERIA FOR SHOULDER AND ROADWAY WIDTHS BASED ON:

OHIO  
ODOT LOCATION AND DESIGN MANUAL, VOL. 1

KENTUCKY  
KYTC HIGHWAY DESIGN MANUAL  
AASHTO ROADSIDE DESIGN GUIDE  
AASHTO "GREEN BOOK" (A POLICY ON GEOMETRIC DESIGN OF HIGHWAYS AND STREETS)

CRITICAL PROPOSED CROSS SECTIONS  
STATION 18

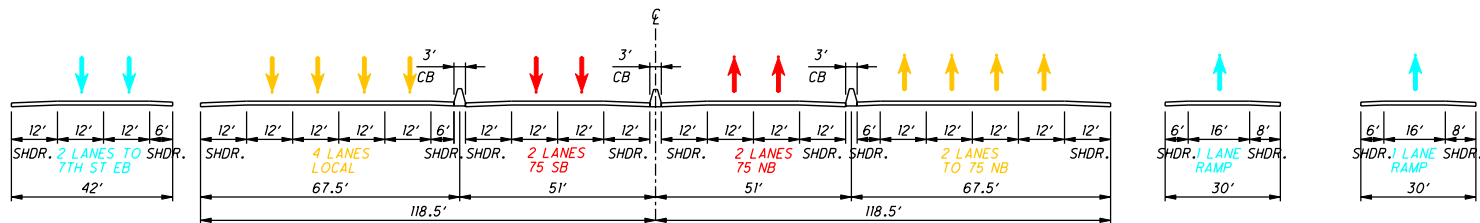

ALTERNATIVE G

NOTE:  
DESIGN CRITERIA FOR SHOULDER AND ROADWAY WIDTHS BASED ON:

OHIO  
ODOT LOCATION AND DESIGN MANUAL, VOL. 1

KENTUCKY  
KYTC HIGHWAY DESIGN MANUAL  
AASHTO ROADSIDE DESIGN GUIDE  
AASHTO "GREEN BOOK" (A POLICY ON GEOMETRIC DESIGN OF HIGHWAYS AND STREETS)

SHEET  
(30 OF 43)

**CRITICAL PROPOSED CROSS SECTIONS  
STATION 18**

**EXHIBIT  
B6-DD**

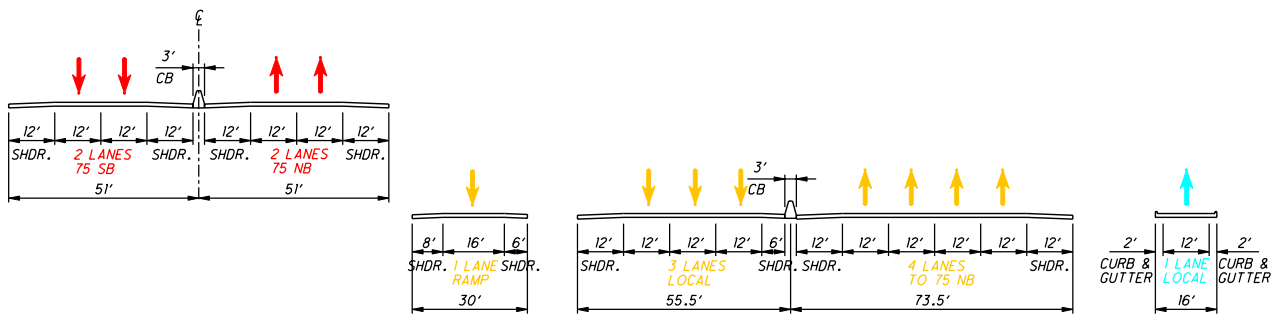

ALTERNATIVE B

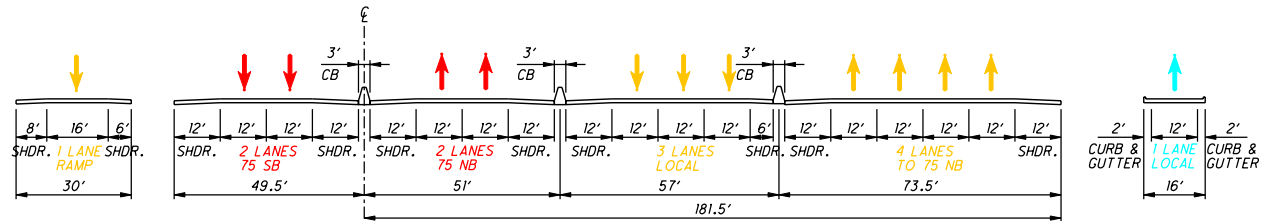

ALTERNATIVE C

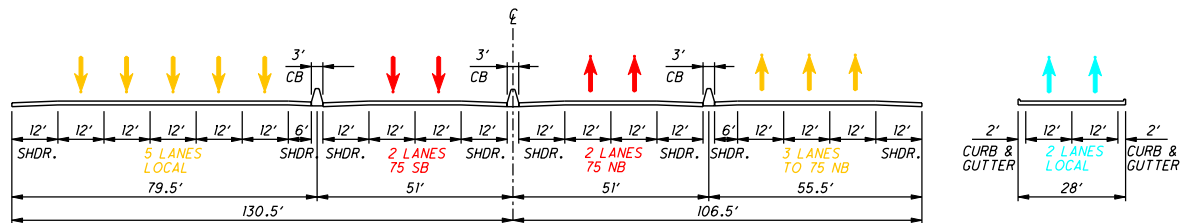

ALTERNATIVE D

NOTE:  
DESIGN CRITERIA FOR SHOULDER AND  
ROADWAY WIDTHS BASED ON:

OHIO  
ODOT LOCATION AND DESIGN MANUAL, VOL. 1

KENTUCKY  
KYTC HIGHWAY DESIGN MANUAL  
AASHTO ROADSIDE DESIGN GUIDE  
AASHTO "GREEN BOOK"  
(A POLICY ON GEOMETRIC DESIGN OF HIGHWAYS AND STREETS)

SHEET  
(31 OF 43)

EXHIBIT

B6-EE

CRITICAL PROPOSED CROSS SECTIONS  
STATION 19



Prepared by  
PARSONS  
BRINCKERHOFF



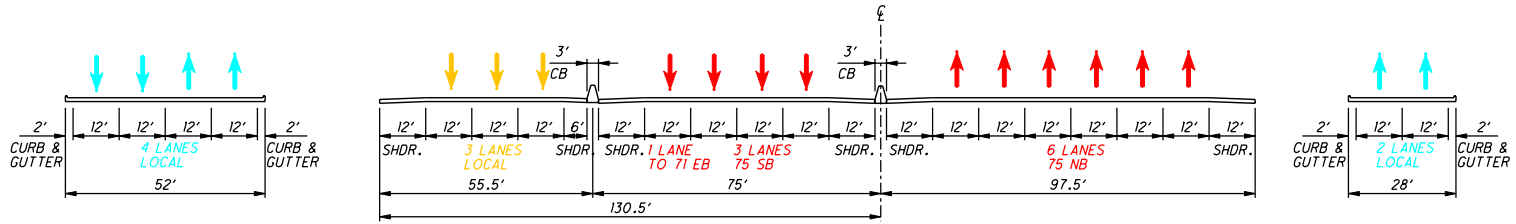

ALTERNATIVE E

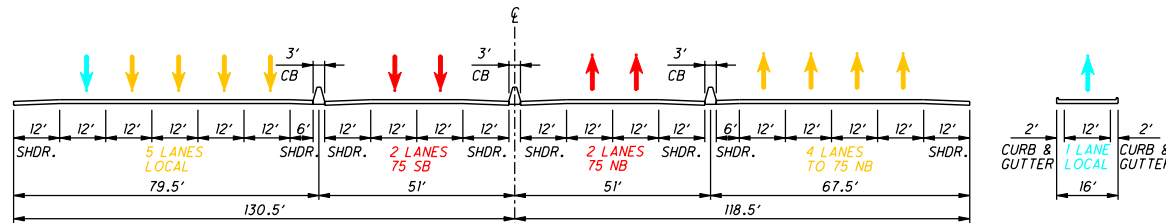

ALTERNATIVE G

NOTE:  
DESIGN CRITERIA FOR SHOULDER AND  
ROADWAY WIDTHS BASED ON:

OHIO  
ODOT LOCATION AND DESIGN MANUAL, VOL. 1

KENTUCKY  
KYTC HIGHWAY DESIGN MANUAL  
AASHTO ROADSIDE DESIGN GUIDE  
AASHTO "GREEN BOOK" (A POLICY ON GEOMETRIC DESIGN OF HIGHWAYS AND STREETS)

SHEET  
(32 OF 43)

EXHIBIT  
B6-FF

CRITICAL PROPOSED CROSS SECTIONS  
STATION 19

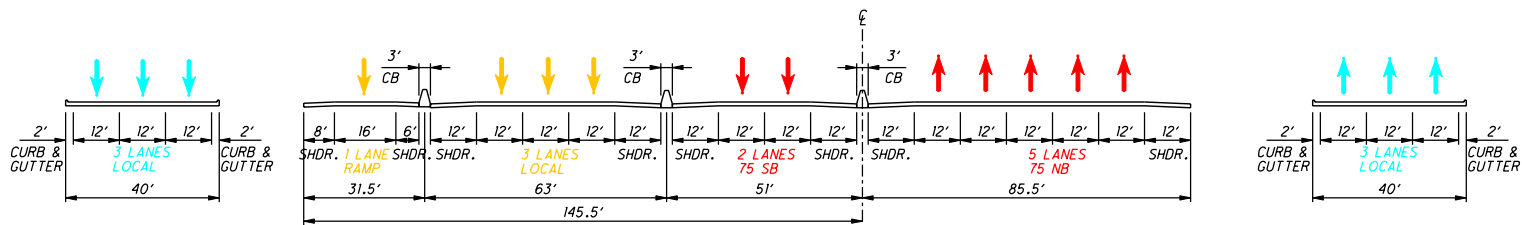

ALTERNATIVE B

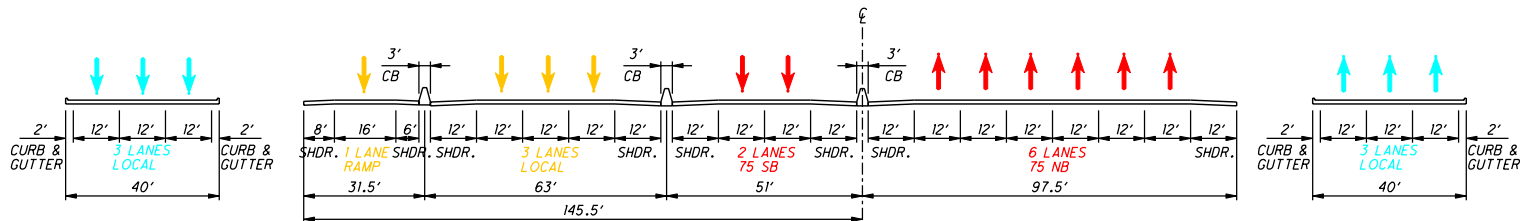

ALTERNATIVE C

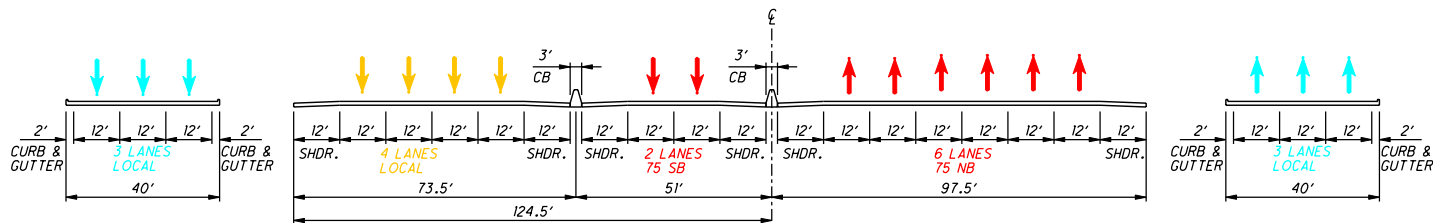

ALTERNATIVE D

NOTE:  
DESIGN CRITERIA FOR SHOULDER AND ROADWAY WIDTHS BASED ON:

OHIO  
ODOT LOCATION AND DESIGN MANUAL, VOL. 1

KENTUCKY  
KYTC HIGHWAY DESIGN MANUAL  
AASHTO ROADSIDE DESIGN GUIDE  
AASHTO "GREEN BOOK" (A POLICY ON GEOMETRIC DESIGN OF HIGHWAYS AND STREETS)

CRITICAL PROPOSED CROSS SECTIONS  
STATION 20

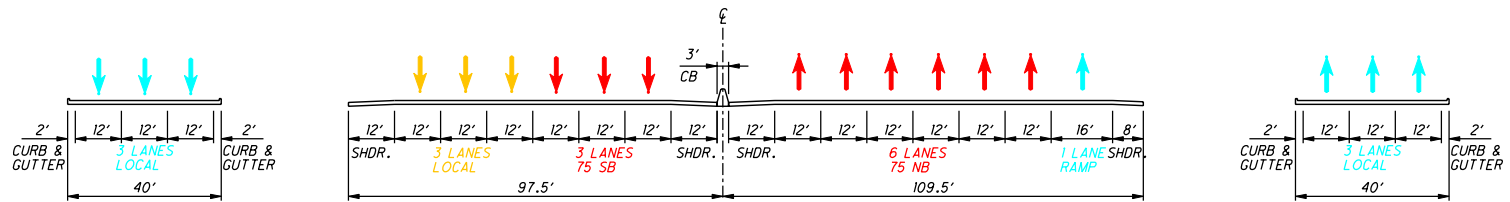

ALTERNATIVE E

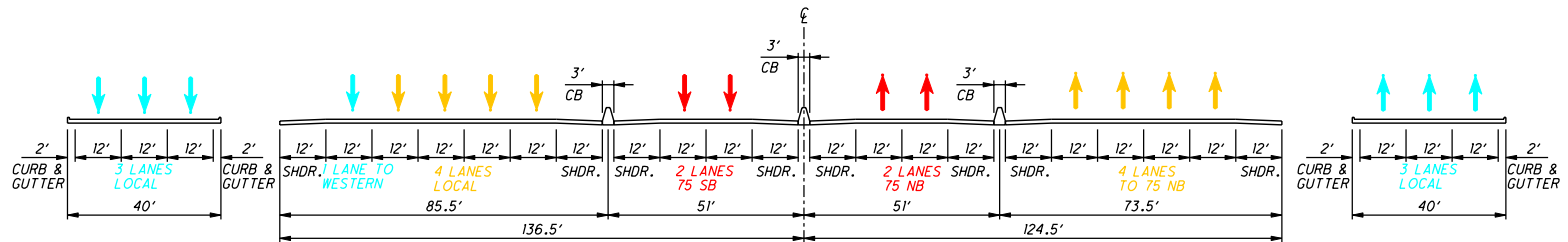

ALTERNATIVE G

NOTE:  
DESIGN CRITERIA FOR SHOULDER AND ROADWAY WIDTHS BASED ON:

OHIO  
ODOT LOCATION AND DESIGN MANUAL, VOL. 1

KENTUCKY  
KYTC HIGHWAY DESIGN MANUAL  
AASHTO ROADSIDE DESIGN GUIDE  
AASHTO "GREEN BOOK" (A POLICY ON GEOMETRIC DESIGN OF HIGHWAYS AND STREETS)

SHEET  
(34 OF 43)

EXHIBIT  
B6-HH

CRITICAL PROPOSED CROSS SECTIONS  
STATION 20

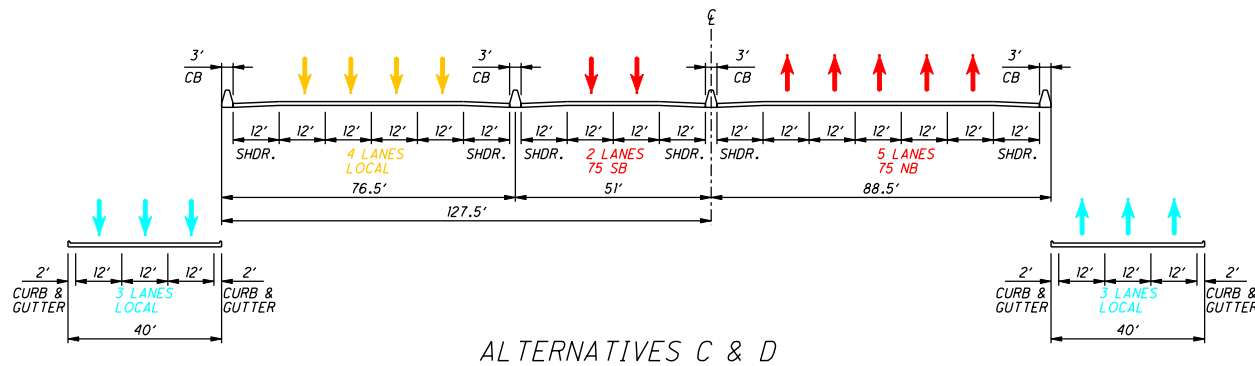
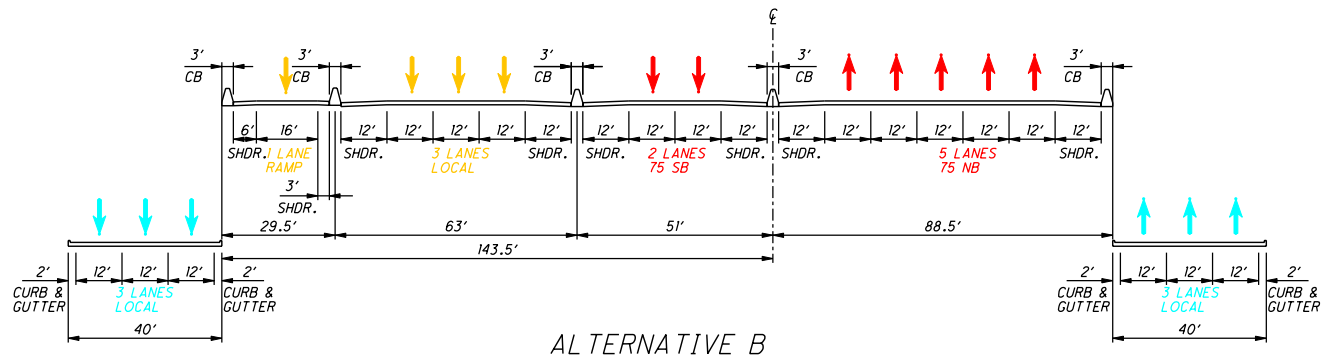

NOTE:  
DESIGN CRITERIA FOR SHOULDER AND ROADWAY WIDTHS BASED ON:

OHIO  
ODOT LOCATION AND DESIGN MANUAL, VOL. 1

KENTUCKY  
KYTC HIGHWAY DESIGN MANUAL  
AASHTO ROADSIDE DESIGN GUIDE  
AASHTO "GREEN BOOK" (A POLICY ON GEOMETRIC DESIGN OF HIGHWAYS AND STREETS)

SHEET  
(35 OF 43)

EXHIBIT

B6-II

## CRITICAL PROPOSED CROSS SECTIONS STATION 21

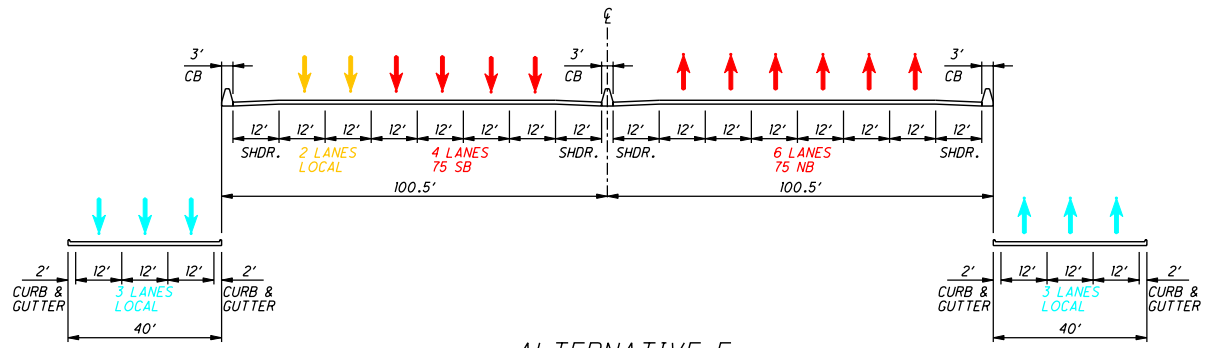

ALTERNATIVE E

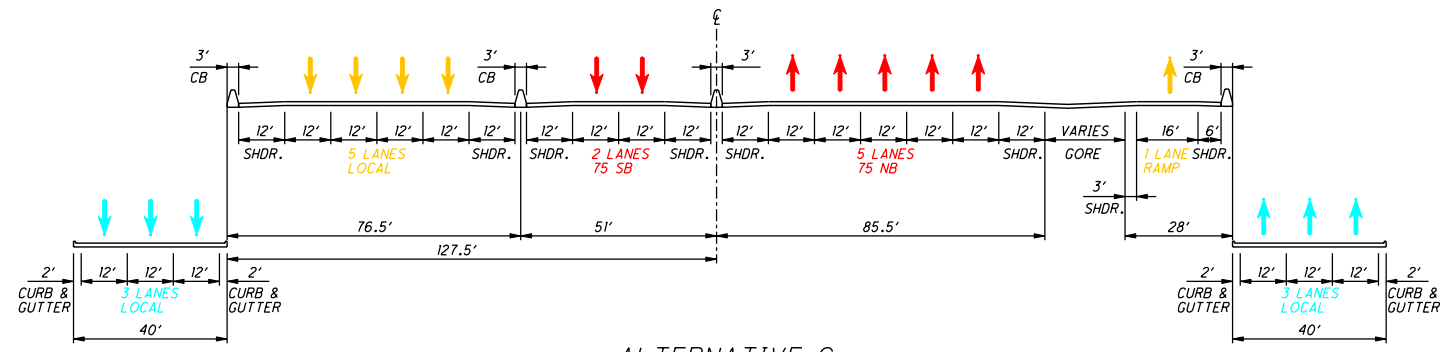

ALTERNATIVE G

**NOTE:**  
 DESIGN CRITERIA FOR SHOULDER AND ROADWAY WIDTHS BASED ON:  
 OHIO  
 ODOT LOCATION AND DESIGN MANUAL, VOL. 1  
 KENTUCKY  
 KYTC HIGHWAY DESIGN MANUAL  
 AASHTO ROADSIDE DESIGN GUIDE  
 AASHTO "GREEN BOOK" (A POLICY ON GEOMETRIC DESIGN OF HIGHWAYS AND STREETS)

**CRITICAL PROPOSED CROSS SECTIONS  
 STATION 21**



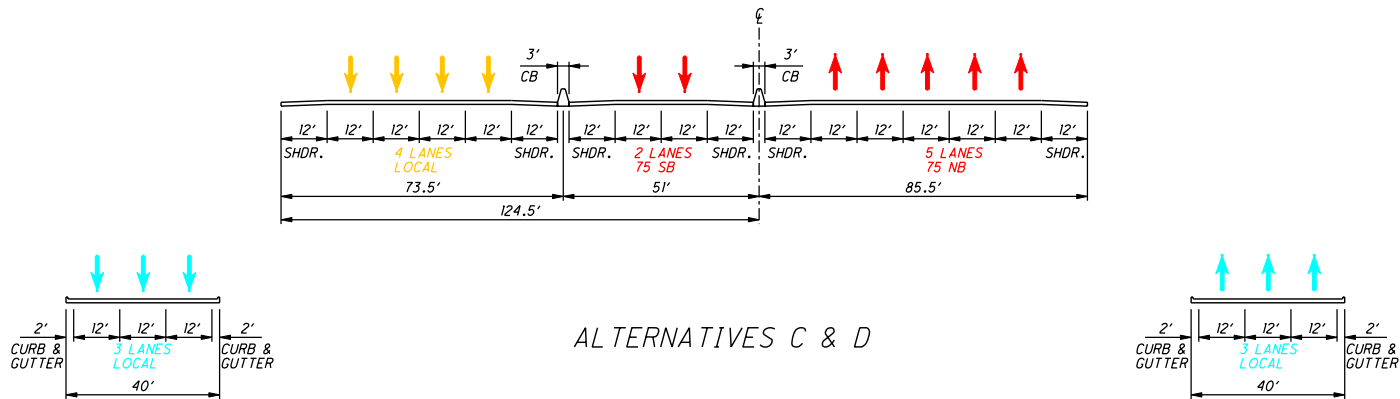
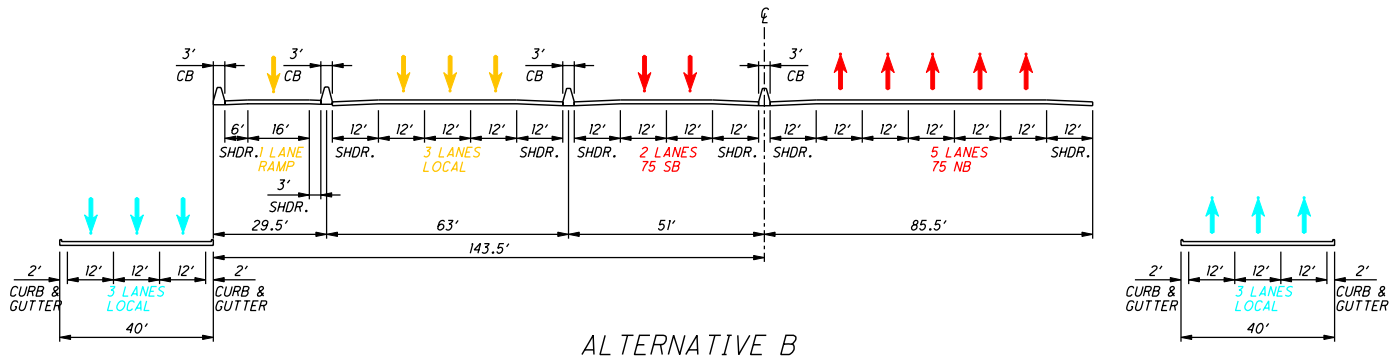

**NOTE:**  
 DESIGN CRITERIA FOR SHOULDER AND ROADWAY WIDTHS BASED ON:

OHIO  
 ODOT LOCATION AND DESIGN MANUAL, VOL. 1

KENTUCKY  
 KYTC HIGHWAY DESIGN MANUAL  
 AASHTO ROADSIDE DESIGN GUIDE  
 AASHTO "GREEN BOOK" (A POLICY ON GEOMETRIC DESIGN OF HIGHWAYS AND STREETS)

SHEET  
 (37 OF 43)

**EXHIBIT**  
**B6-KK**

**CRITICAL PROPOSED CROSS SECTIONS  
 STATION 22**



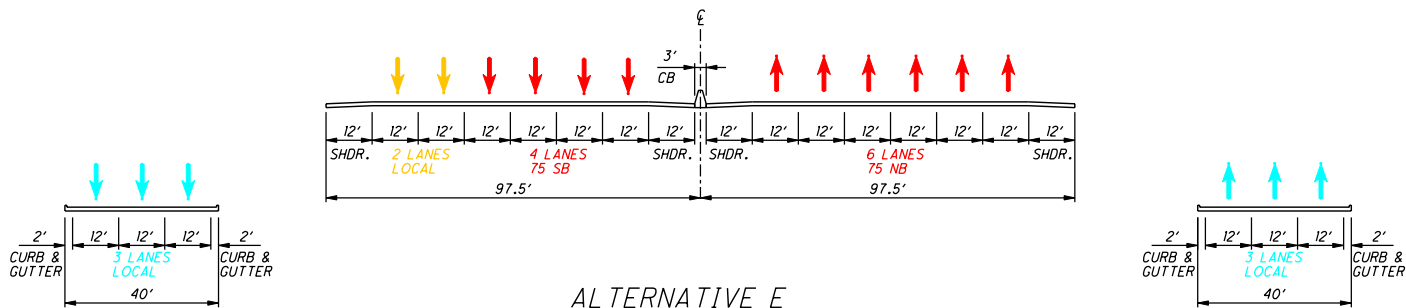

ALTERNATIVE E

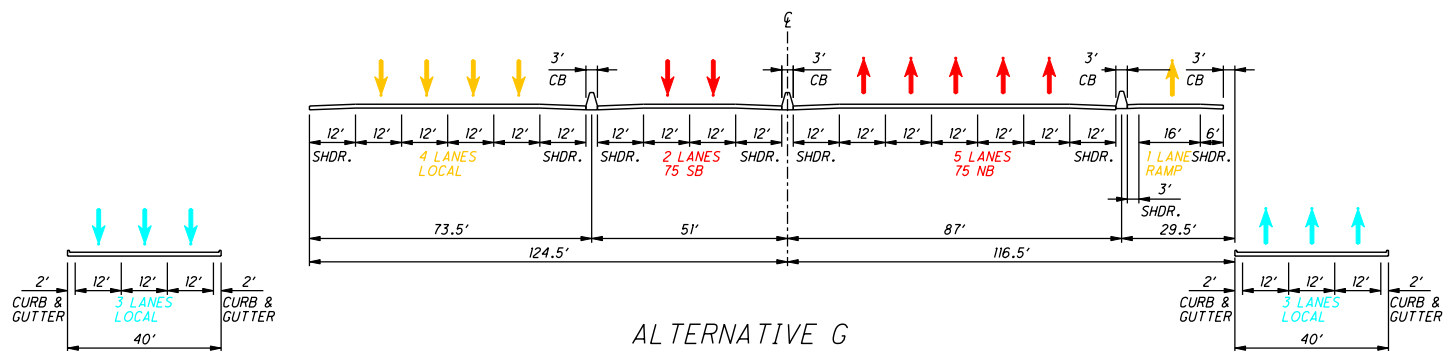

ALTERNATIVE G

NOTE:  
DESIGN CRITERIA FOR SHOULDER AND ROADWAY WIDTHS BASED ON:

OHIO  
ODOT LOCATION AND DESIGN MANUAL, VOL. 1

KENTUCKY  
KYTC HIGHWAY DESIGN MANUAL  
AASHTO ROADSIDE DESIGN GUIDE  
AASHTO "GREEN BOOK" (A POLICY ON GEOMETRIC DESIGN OF HIGHWAYS AND STREETS)

SHEET  
(38 OF 43)

EXHIBIT  
B6-LL

CRITICAL PROPOSED CROSS SECTIONS  
STATION 22



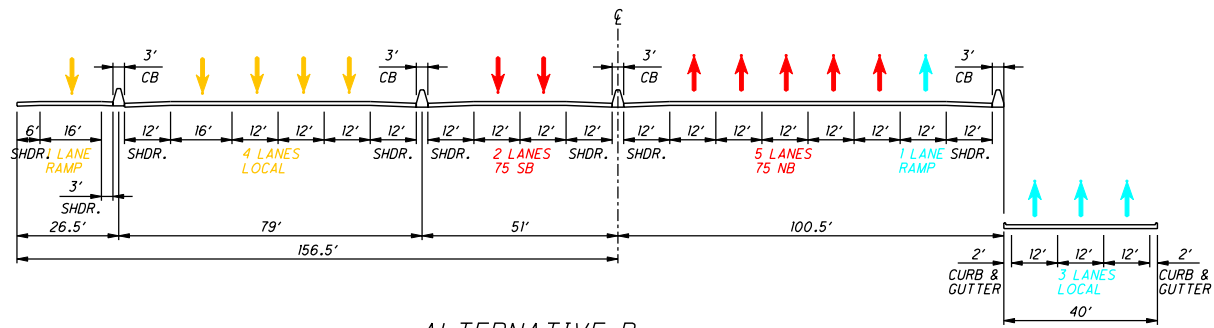

ALTERNATIVE B

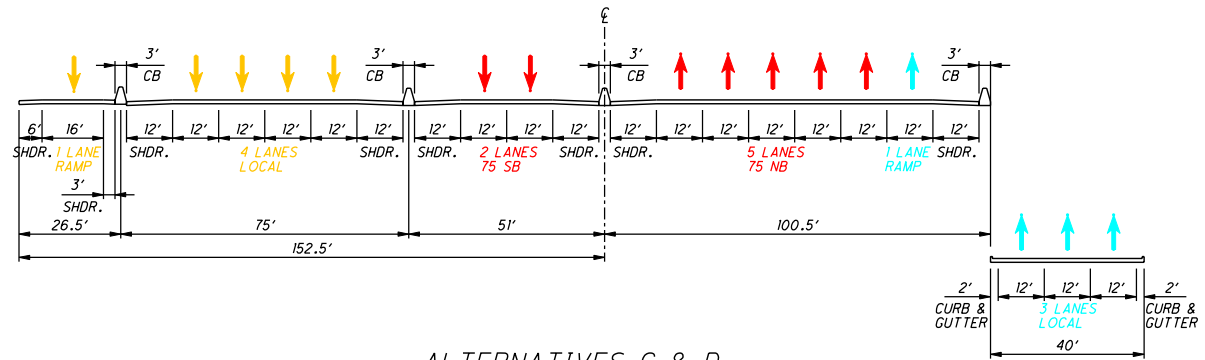

ALTERNATIVES C & D

**NOTE:**  
 DESIGN CRITERIA FOR SHOULDER AND ROADWAY WIDTHS BASED ON:  
 OHIO  
 ODOT LOCATION AND DESIGN MANUAL, VOL. 1  
 KENTUCKY  
 KYTC HIGHWAY DESIGN MANUAL  
 AASHTO ROADSIDE DESIGN GUIDE  
 AASHTO "GREEN BOOK" (A POLICY ON GEOMETRIC DESIGN OF HIGHWAYS AND STREETS)

**CRITICAL PROPOSED CROSS SECTIONS  
 STATION 23**





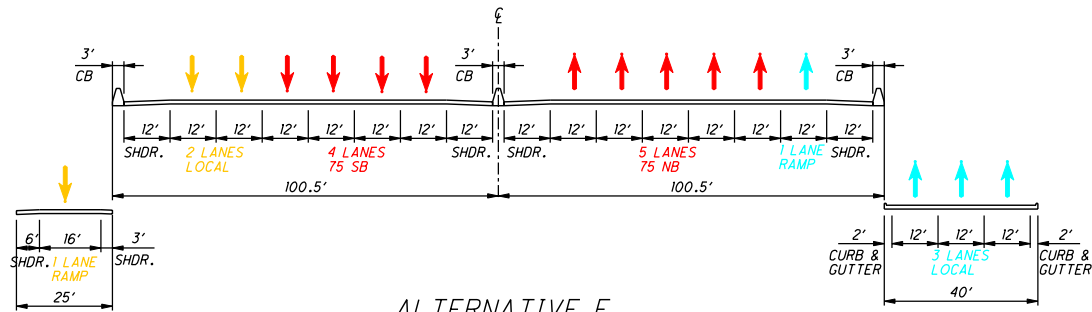

ALTERNATIVE E

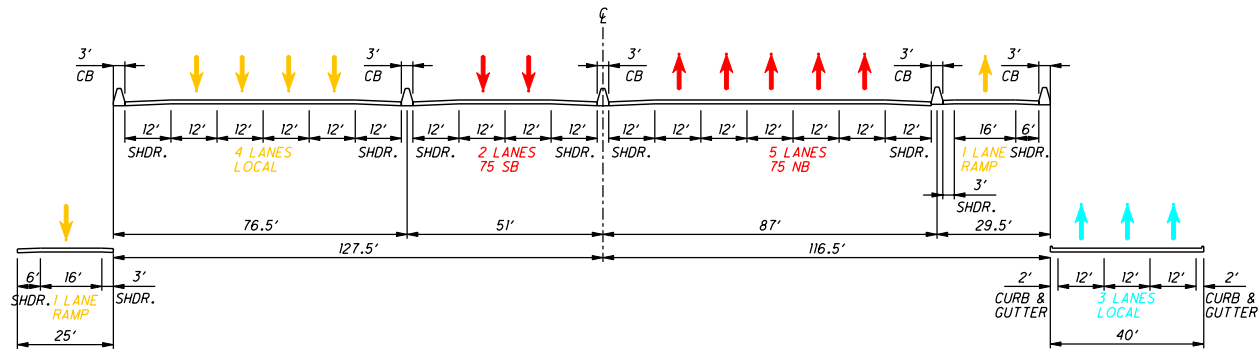

ALTERNATIVE G

NOTE:  
DESIGN CRITERIA FOR SHOULDER AND ROADWAY WIDTHS BASED ON:

OHIO  
ODOT LOCATION AND DESIGN MANUAL, VOL. 1

KENTUCKY  
KYTC HIGHWAY DESIGN MANUAL  
AASHTO ROADSIDE DESIGN GUIDE  
AASHTO "GREEN BOOK" (A POLICY ON GEOMETRIC DESIGN OF HIGHWAYS AND STREETS)

SHEET  
(40 OF 43)

EXHIBIT  
B6-NN

CRITICAL PROPOSED CROSS SECTIONS  
STATION 23

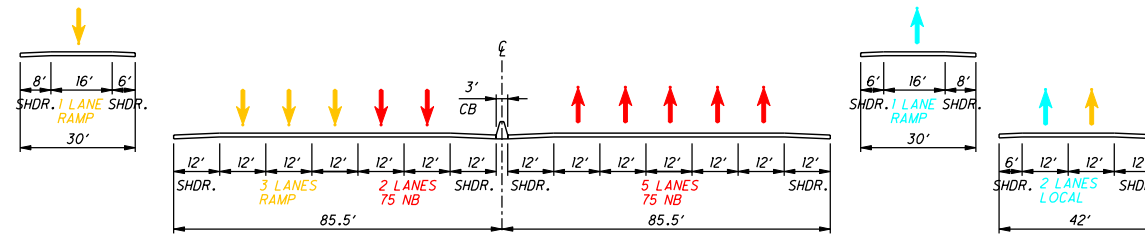

ALTERNATIVES B & D

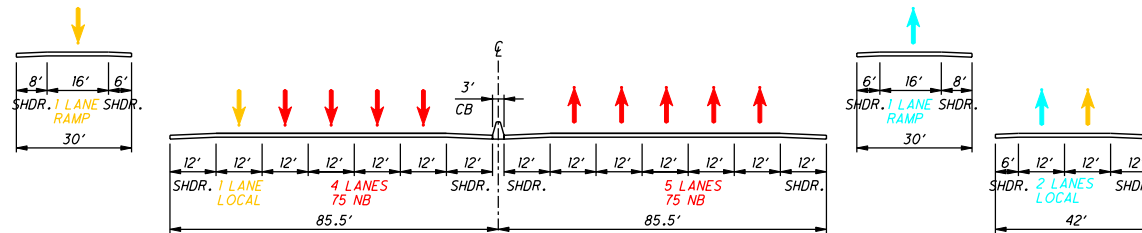

ALTERNATIVE E

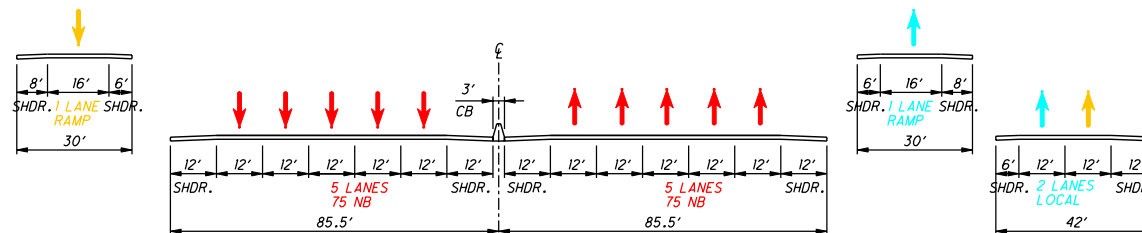

ALTERNATIVES C & G

NOTE:  
DESIGN CRITERIA FOR SHOULDER AND  
ROADWAY WIDTHS BASED ON:

OHIO  
ODOT LOCATION AND DESIGN MANUAL, VOL. 1

KENTUCKY  
KYTC HIGHWAY DESIGN MANUAL  
AASHTO ROADSIDE DESIGN GUIDE  
AASHTO "GREEN BOOK"  
(A POLICY ON GEOMETRIC DESIGN OF HIGHWAYS AND STREETS)

CRITICAL PROPOSED CROSS SECTIONS  
STATION 24

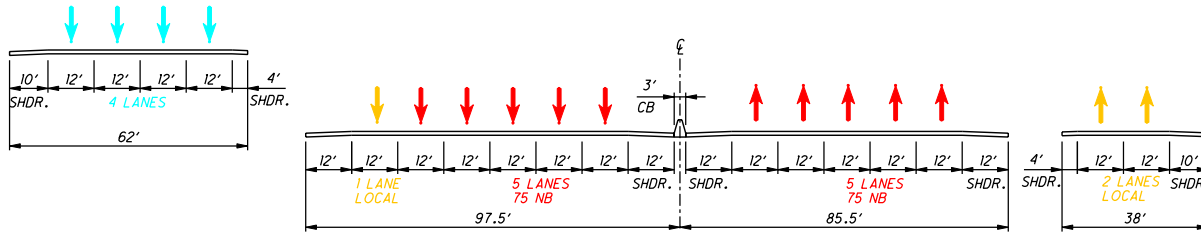

ALTERNATIVES B, C, & E

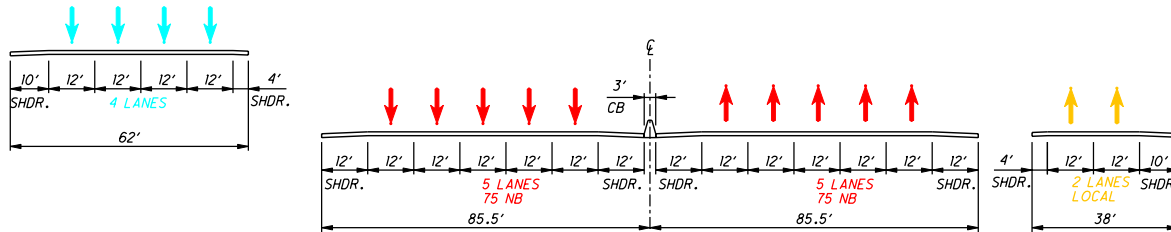

ALTERNATIVES D & G

NOTE:  
DESIGN CRITERIA FOR SHOULDER AND ROADWAY WIDTHS BASED ON:

OHIO  
ODOT LOCATION AND DESIGN MANUAL, VOL. 1

KENTUCKY  
KYTC HIGHWAY DESIGN MANUAL  
AASHTO ROADSIDE DESIGN GUIDE  
AASHTO "GREEN BOOK" (A POLICY ON GEOMETRIC DESIGN OF HIGHWAYS AND STREETS)

SHEET  
(42 OF 43)

EXHIBIT  
B6-PP



**CRITICAL PROPOSED CROSS SECTIONS  
STATION 25**

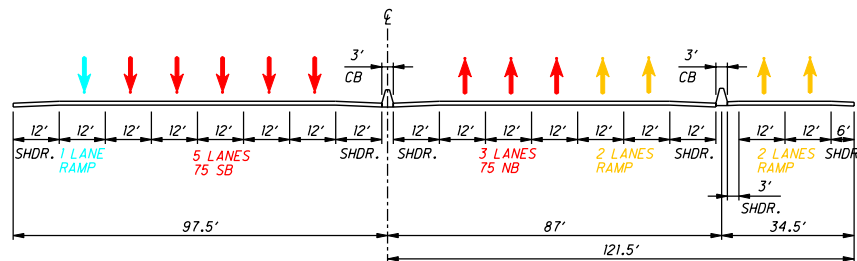

ALTERNATIVES B, C, D, E, & G

**NOTE:**  
DESIGN CRITERIA FOR SHOULDER AND ROADWAY WIDTHS BASED ON:

OHIO  
ODOT LOCATION AND DESIGN MANUAL, VOL. 1

KENTUCKY  
KYTC HIGHWAY DESIGN MANUAL  
AASHTO ROADSIDE DESIGN GUIDE  
AASHTO "GREEN BOOK" (A POLICY ON GEOMETRIC DESIGN OF HIGHWAYS AND STREETS)

SHEET  
(43 OF 43)

EXHIBIT

B6-QQ

**CRITICAL PROPOSED CROSS SECTIONS  
STATION 26**

U.S. Department of Transportation  
Federal Highway Administration



Prepared by  
**PARSONS  
BRINCKERHOFF**

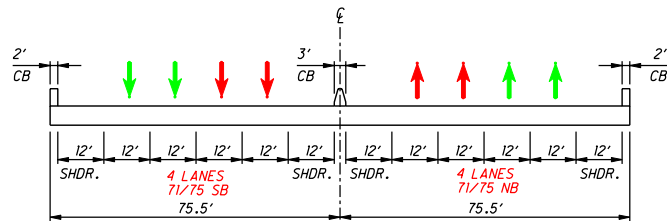

PROPOSED NEW BRIDGE

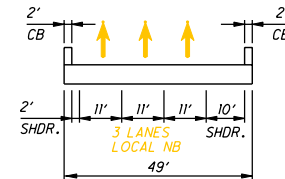
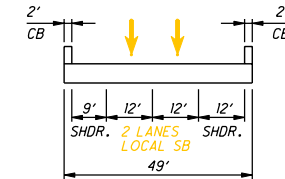

EXISTING BRENT SPENCE BRIDGE

ALTERNATIVE B

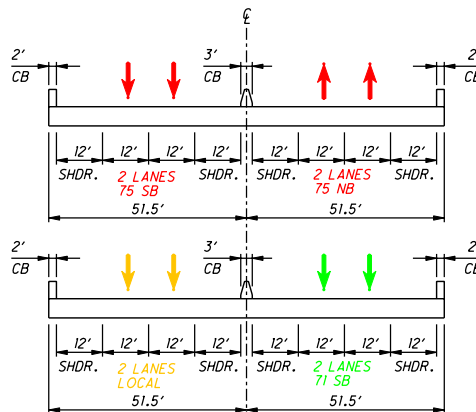

PROPOSED NEW BRIDGE

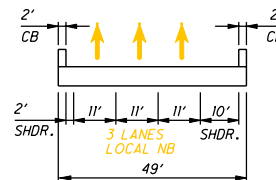
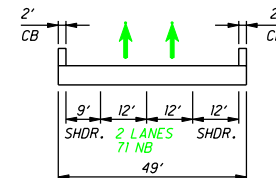

EXISTING BRENT SPENCE BRIDGE

ALTERNATIVES C, D & G

NOTE:  
DESIGN CRITERIA FOR SHOULDER AND  
ROADWAY WIDTHS BASED ON:

OHIO  
ODOT LOCATION AND DESIGN MANUAL, VOL. 1

KENTUCKY  
KYTC HIGHWAY DESIGN MANUAL  
AASHTO ROADSIDE DESIGN GUIDE  
AASHTO "GREEN BOOK"  
(A POLICY ON GEOMETRIC DESIGN OF HIGHWAYS AND STREETS)

SHEET  
(1 OF 2)

EXHIBIT  
B7-A

CRITICAL PROPOSED CROSS SECTIONS  
MAIN SPAN BRIDGE



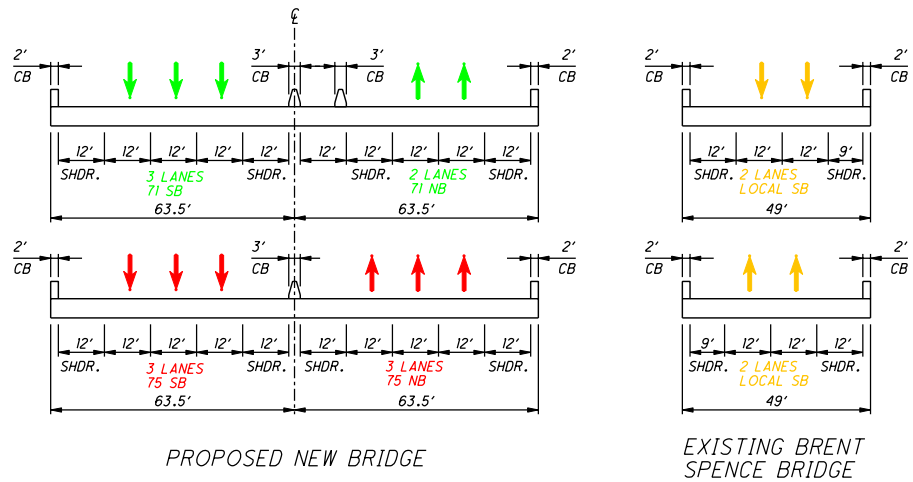

ALTERNATIVE E

NOTE:  
DESIGN CRITERIA FOR SHOULDER AND ROADWAY WIDTHS BASED ON:

OHIO  
ODOT LOCATION AND DESIGN MANUAL, VOL. 1

KENTUCKY  
KYTC HIGHWAY DESIGN MANUAL  
AASHTO ROADSIDE DESIGN GUIDE  
AASHTO "GREEN BOOK" (A POLICY ON GEOMETRIC DESIGN OF HIGHWAYS AND STREETS)

SHEET  
(2 OF 2)

CRITICAL PROPOSED CROSS SECTIONS  
MAIN SPAN BRIDGE

EXHIBIT  
B7-B



## **LIST OF APPENDICES**

- Appendix C. Engineering Files – Click [Here](#)  
    Geometric Design Exceptions  
    Geometric Plan and Profiles  
    Signage Plan  
    Line Diagrams
- Appendix D. Cost Estimates – Click [Here](#)
- Appendix E. Public Involvement Activities and Coordination – Click [Here](#)  
    Summary of Concurrence Point #1  
    Public Comments Received  
    Project Newsletters  
    Potential Employment and Property Impact Survey (January 2009)
- Appendix F. Previous Reports  
    Purpose and Need Statement (May 2006) – Click [Here](#)  
    Red Flag Summary (December 2005) – Click [Here](#)  
    Existing and Future Conditions (February 2006) – Click [Here](#)  
    Planning Study Report (September 2006) – Click [Here](#)  
    Public Involvement Plan (October 2005) – Click [Here](#)  
    Origin – Destination Study (March 2006) – Click [Here](#)  
    I-71/US 50 Origin – Destination Study (January 2007) – Click [Here](#)
- Appendix G. Utility Coordination – Click [Here](#)
- Appendix H. Constructability Workshop – Click [Here](#)
-